

# APPLICABILITY OF INTELLIGENT ELECTRIC GRID

Arctic Energy Project

Pietilä, Petri

Bachelor's Thesis  
Industry and Natural Resources  
Electrical Engineering  
BEng. (Tech)  
2017

Tekniikan- ja liikenteen ala  
Sähkö- ja automaatiotekniikka  
Insinööri AMK

---

<b>Tekijä</b>	Petri Pietilä	Vuosi	2017
<b>Ohjaaja</b>	Ins. (AMK) Aila Petäjäjärvi		
<b>Toimeksiantaja</b>	Lapin AMK		
<b>Työn nimi</b>	Ins. (AMK) Mikko Rintala		
<b>Sivu- ja liitesivumäärä</b>	Älykkäiden sähköverkkojen sovellettavuus 68		

---

Opinnäytetyön tarkoituksena oli tutkia älyverkkoratkaisuja ja soveltaa löydettyjä teknologioita vastaamaan seuraaviin tutkimusongelmiin: älykkäiden sähköverkkojen mahdollistava vaikutus tuotantoon ja energian varastointiin, käytön mahdollinen poissulkeva vaikutus, älykkäiden sähköverkkojen käytön vaikutus asiakkaiden toimintaan, vaikutus kaksisuuntaiseen tehonsiirtoon, mahdollisuudet kuorman ja tuotannon ohjauksessa sekä turvaraja- ja kapasiteettirajaominaisuudet.

Opinnäytetyössä kiteytetään mitä tarkoittaa esimerkiksi älyverkko 1.0. Aiheita käsiteltiin jakeluverkon ja sähkön loppukäyttäjän näkökulmista. Työssä käsiteltiin myös älykkään sähköverkon tietoturva, hajautettua tuotantoa, sähköisiä kulkuneuvoja ja sähkövarastoja.

Opinnäytetyö tehtiin yhteistyönä Lapin ammattikorkeakoulun teollisuuden ja luonnonvarojen osaamisalan tutkimus-, kehittämis - ja innovaatio-osaston kanssa. Työ oli osa Arctic Energy -projektin työpakettia 4.1 ja Lapin ammattikorkeakoululle suunnattuja tutkimuskysymyksiä.

Työ tehtiin englannin kielellä, sillä projektissa toimivat ihmiset työskentelevät Suomen lisäksi Ruotsissa ja Norjassa, jolloin yhteisenä kielenä toimii englanti. Työ toteutettiin tiedonhakuna ja soveltamalla löydettyä tietoa tutkimuskysymyksiin. Lähteinä käytettiin julkisesti saatavilla olevia asiakirjoja kuten kirjoja, e-kirjoja ja internetissä julkaistuja alan materiaaleja.

Tulokset palvelivat työpaketin tavoitteita ja antoivat tarvittavaa tietoa älykkäistä sähköverkoista projektissa mukana olleille ihmisille. Työlle asetetut tavoitteet täyttyivät ja tulokset vastaavat tutkimusongelmiin.

Avainsanat

Smart grid, älykäs sähköverkko, älykäs voimaverkko, hajautettu tuotanto, energiavarasto

Technology, Communication and  
Transportation  
Electrical Engineering  
Bachelor of Engineering

---

<b>Author</b>	Petri Pietilä	Year	2017
<b>Supervisor</b>	Aila Petäjäjärvi, BEng.		
<b>Commissioned by</b>	Lapland University of Applied Sciences Mikko Rintala, BEng.		
<b>Subject of thesis</b>	Applicability of Intelligent Electric Grid		
<b>Number of pages</b>	68		

---

The purpose of the thesis was to do study Smart Grid solutions and apply the found technologies to answer to the following research problems: the enabling effect of Smart Grids on energy storage and production, exclusivity effect of using Smart Grid technologies, usage effect of the Smart Grid technology on customer level, Smart Grid solutions for a two-way power transfer, Smart Grid solutions for energy production control and load control possibilities and Smart Grid solutions and usage for safety margins and reserve margins.

The thesis gives an insight into what it is meant by for example Smart Grid 1.0. The topics deals with the aspects of the distribution network and end-users of electricity. The security of the Smart Grid, distributed generation, electrical vehicles, and electricity storages are also presented.

The thesis was carried out in collaboration with the Industry and Natural Resources RDI of Lapland University of Applied Sciences. The thesis was part of the Arctic Energy project's work package 4.1 defined tasks for Lapland University of Applied Sciences.

The work was written in English with the intention that people who work in the project are apart from Finland also from Sweden and Norway in which case English works as a common language. The thesis was executed as information retrieval and by applying the found information to the research problems. All the publicly available documents such as books, e-books and the literature in the field found on the internet was used as documentary material.

The results of the thesis serves the targets of the work package and gave the needed information about the Smart Grid solutions to the people involved in the project. The aim set for the work was fulfilled and the results corresponds to the research problems.

**Keywords** Smart Grid, intelligent electricity grid, intelligent power grid, distributed generation, electricity storage

## SISÄLLYS

1	INTRODUCTION .....	10
2	INTELLIGENT ELECTRICITY GRID .....	11
2.1	Traditional Power Grid .....	12
2.2	Power System in Finland .....	13
2.3	Smart Grid .....	14
2.4	Communication in Smart Grid.....	17
2.5	Smart Grid 1.0 in Finland.....	20
3	DISTRIBUTION OF ELECTRICITY .....	22
3.1	Substation Automation.....	22
3.2	Smart Metering .....	23
3.3	Network Automation Technology .....	26
3.3.1	Information Systems.....	27
3.3.2	Reading System.....	27
3.3.3	Measurement Database .....	28
3.3.4	Distribution Management System.....	28
3.3.5	Network Control System.....	28
3.3.6	Customer Information System.....	28
3.3.7	Systems Control and Data Acquisition .....	29
3.3.8	Network Information System .....	29
3.3.9	Communication Technology in Smart Grid.....	29
3.3.10	Aidon Oy AMM Solutions .....	31
3.4	Methods of Data Transmission .....	32
3.5	Low Voltage Direct Current Distribution .....	33
4	SMART GRID SECURITY .....	37
4.1	Communication of Meters and Reading Systems .....	38
4.2	Load Management .....	38
4.3	Privacy Problems .....	39
4.4	Metering and Meters .....	39
5	DISTRIBUTED GENERATION .....	41
5.1	Micro Production.....	42

5.2	Emergency Power.....	43
5.3	Small Scale Hydro Power .....	43
5.4	Solar Power .....	43
5.5	Wind Power.....	44
6	INTEGRATING ELECTRICAL VEHICLES INTO SMART GRID.....	46
6.1	Vehicles as Part of the Grid .....	46
6.2	Sources of EV Battery Charging System .....	47
6.3	Batteries in Electric Vehicle .....	49
6.4	eBus System.....	49
7	ELECTRICITY STORAGE.....	51
7.1	Pumped Hydro-Power.....	51
7.2	Solid State Batteries .....	53
7.3	Flow Batteries .....	55
7.4	Flywheels.....	56
7.5	Compressed Air Storage.....	56
7.6	Thermal.....	57
7.7	Electric Traction Drive Shuttle-Trains.....	57
8	RESEARCH RESULTS .....	58
8.1	Smart Grid Enabling Effect on Energy Storage and Production.....	58
8.2	Exclusivity Effect of Using Smart Grid Technologies .....	59
8.3	Usage Effect of the Smart Grid Technology on Customer Level.....	59
8.4	Load Control Possibilities in Smart Grids.....	60
8.5	Smart Grid Solutions for Two Way Power Transfer .....	61
8.6	Smart Grid Solutions for Energy Production Control.....	62
8.7	Smart Grid Solutions and Usage for Safety Margins and Reserve Margins.....	62
9	CONCLUSION.....	64
	REFERENCES .....	65

## ACKNOWLEDGEMENT

I would like to express my sincere gratitude to the instructor of this paper Mikko Rintala for an interesting topic and the assistance in the work. I would also like to thank the supervisor Aila Petäjajarvi from Lapland University of Applied Sciences for guidance in the thesis.

Kemi 7 May 2017

Petri Pietilä

## Abbreviations

2G/3G	Second Generation / Third Generation
AC	Alternative Current
AMI	Automated Metering Infrastructure
AMM	Automated Meter Management
AMR	Automated Meter Reading
APN	Access Point Name
CAES	Compressed Air Energy
CIS	Customer Information System
DA	Distribution Automation
DC	Direct Current
DG	Distributed Generation
DLMS	Device Language Message Specification
DMS	Distribution Management System
DSO	Distribution System Operators
EC	Electrochemical Capacitors
EDI	Electronic Data Interchange
EU	European Union
EV	Electric Vehicle
FESS	Flywheel Energy Storage Systems
GPRS	General Packet Radio Service
GSM	Global System for Mobile
GW	Giga Watt
GWh	Giga Watt Hour
HUB	A common connection point for devices in network
ICT	Information and Communication Technology
ISDN	Integrated Services Digital Network

IT	Information Technology
LAN	Local Area Network
LI-ION	Lithium Ion
LVDC	Low Voltage Direct Current
Mhz	Mega Hertz
MW	Mega Watt
MWh	Mega Watt Hour
NAS	Sodium Sulfur
NCS	Network Control System
NI-CD	Nickel-Cadmium
NIS	Network Information System
OSSV	Oulun Seudun Sähkö Verkkopalvelut
PGM	Probabilistic Graphical Model
PLC	Power Line Carrier
PSH	Pumped Storage Hydroelectricity
PSTN	Public Switched Telephone Network
PtG	Power to Gas
PV	Photo Voltaic
R & D	Research and Development
RF Mesh	Radio Frequency Mesh
RFID	Radio Frequency Identification
RTU	Remote Terminal Unit
SCADA	Systems Control and Data Acquisition
SFS	Finnish Standards Association
SIM	Subscriber Identity Module
V	Volt
VA	Volt Amperes



W

Watt

## 1 INTRODUCTION

The subject of the thesis is really interesting, topical and growing. The subject supported the progress of the Arctic Energy project and fit into the current studies. The main study areas of the thesis was to find answers to the research questions and the area of the subject revolves around those questions. As the concept of the Smart Grid can be extensive, the thesis focuses on a general view of Smart Grid solutions.

The thesis introduces an intelligent electricity grid also known as Smart Grid, which is a fairly new concept and what are the other aspects of the Smart Grid. The thesis covers also the concept of the traditional electricity grid. The communication technology is viewed on a general level but it also covers some profound aspects. There is also information about Nordic power system and the electricity network in the U.S.A.

Smart Grid solutions are topical in today's electricity distribution. The energy consumption has globally increased to this day and the traditional power grid will soon be outdated. Electric vehicles are under development and might become more common in the future. Distributed generation has gained momentum and offers new environmentally friendly ways to produce electricity. These trends set new requirements for the electricity network. The traditional electricity network faces challenges and is unable to handle these new requirements. By combining intelligent components and information and communication technology, it is possible to create a more flexible, reliable and efficient electricity network.

## 2 INTELLIGENT ELECTRICITY GRID

Intelligent Electricity Grid also called Smart Grid observes electricity flowing and optimizes consumption and production of electricity. It is a type of electricity network that combines solutions from electrical engineering and automation. With the help of the Smart Grid, it is possible to always produce and consume electricity in the places where it is most profitable. This way the Smart Grid enables profitable use of distributed electricity production and even lowers the CO<sub>2</sub> pollutions. It can also offer even more options of electricity production and consumption for small-scale consumers. (Työ- ja elinkeinoministeriö 2016, Energiateollisuus ry 2016.)

The term is generally associated with technology and process updates, which will bring utility electricity, water and gas delivery systems into the modern age where computer-based remote control, automation and also information and communication technologies are heavily included in Smart Grid solutions. It intelligently integrates the different actions of all users connected to it. This includes electricity providers, consumers and even those who do both. Some say it is the internet of energy. (Energiateollisuus ry 2016.)

It is often said that the Smart Grid can be described as the internet of energy. This is because of the huge increase in the use of information technology included in Smart Grid solutions. The bidirectional energy flow between the customer and energy provider plays a key role when it comes to the Smart Grid. Therefore a smart energy meter is an integral part of the Smart Grid along with distributed production. (Energiateollisuus ry 2016.)

Today's world energy consumption plays an important role in the energy production and sustainable energy solutions. In the future, the field of energy production will scatter on ever smaller units and the amount of renewable energy will increase. Micro production of the field of trade, industrial and an individual customer will be attached as part of large-scale energy production. Even electric vehicles will have an important role in developing Smart Grid solutions and will greatly increase in numbers in the next 20 years. (Landis+Gyr 2016.)

The Smart Grid solutions also offer more flexibility in demand. This supports micro production such as wind and solar power. In the future for example recharging an electric car or heating up the water temperature of a boiler would take place at a time where there is over supply or weak demand of electricity. This way, customers would benefit financially. Along with the Smart Grids, the demand for electricity will be more adaptable to production than today.

## 2.1 Traditional Power Grid

Traditional power grid is designed to produce electricity by the rate it is consumed. The electricity is transferred only in one direction and is produced by centralized power plants. There are also cases where the power flow is not strictly one way such as the reactive power flow. (Bush 2014, 8.)

The very first electric grid was based on the direct current before the benefits of alternative current was discovered. The electric network served only little regions and provided electricity for local demand. In a sense, it was a precursor for micro grids. From 1900 to 1970 the power grid grew 400 times which is significant compared to other forms of energy that grew about 50 times. The need for communication was immediately recognized. The early implementation for communication was through telegraph lines for automated meter readings. The power line carrier for meter reading had patents in Britain in 1898. (Bush 2014, 9.)

Transformers made it possible for high voltage alternative current safely and efficiently distribute electricity via 1000 V power lines. Nikola Tesla invented the induction motor in 1888 and helped to spread the alternative current distribution. The progress resulted in a large number of small electric companies. As the demand for electricity grew and generators became larger, the need to transmit and distribute power became topical. In order to do so, higher voltage was needed to transmit and distribute electricity efficiently. (Bush 2014, 10.)

The traditional power grid in the United States of America is similar to the Nordic power system and follows the same principle but the level of voltage in every distribution and transmission level varies. On the distribution side, it is common to have voltages range in classes of 5, 15, 25, 35 and 69 kV in USA. 60 hertz is used in the electricity distribution in United States, South America and in parts of

Japan. 50 hertz is used generally in Europe. The power system in the USA would seem like in figure 1. (Bush 2014, 10.)

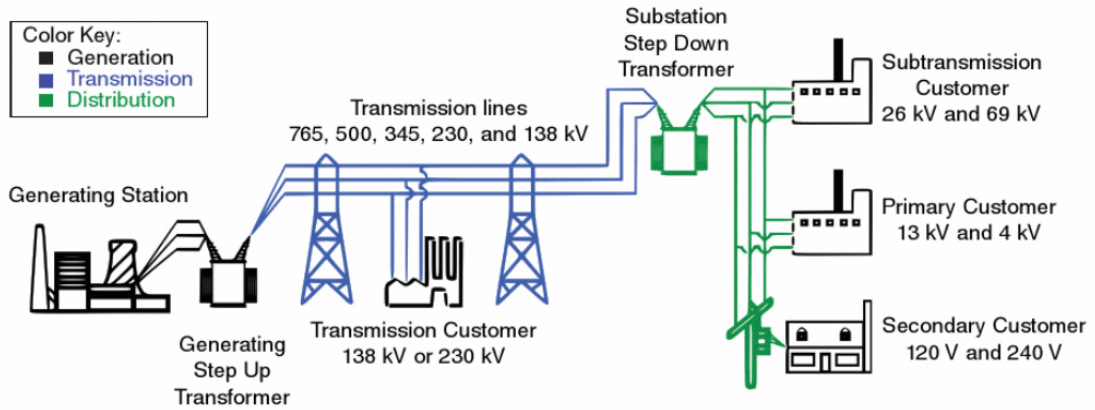

Figure 1. A Classic View of the Power Grid. (Bush 2014, 8.)

## 2.2 Power System in Finland

The power system in Finland consist of power plants, grid, high voltage distribution networks, distribution networks and electricity consumers. The distribution voltages varies from 0.4 to 110 kV. It is part of the Nordic power system together with Sweden's, Norway's and Eastern-Denmark's power system. The Nordic system is interconnected through several direct current (DC) transmission connections. Finland has also a 220 kV AC connection to Norway. The Nordic power system is in a mutual use so it is possible for the countries to use the power system together and support other countries on their electricity usage. There are also HVDC power lines connected from Russia and Estonia. (Fingrid 2016.)

The grid is a backbone network for electricity transmission where big production plants, factories and regional distribution networks are connected. In Finland, there are 4600 km of 400 kV power lines, 2200 km 220 kV power lines, 7600 km of 110 kV power lines and 116 substations. The grid serves electricity producers and electricity consumers enabling mutual trade on the national and cross-border levels. (Fingrid 2016.)

### 2.3 Smart Grid

Nowadays the Smart Grid as a term is more of a marketing term than a technical definition. Because of it, there is no well-defined and commonly accepted definition of what “smart” stands for. Even a basic term “intelligence” has not been clearly defined. It comes to a question, how much machine intelligence and communication are needed for an entity to be intelligent? On the contrary, if the entity is already intelligent does it require less communication to be intelligent enough to infer information without requiring communication? These are quite high-level questions and roam deep into the realm of artificial intelligence but are also worth to review if one considers the meaning of “Smart Grid”. (Bush 2014, 360.)

It can be said that the content of the concept still depends on one’s personal view of the topic. It is also uncertain whether the main change is going to happen on a distribution network or transmission network. But it can be predicted to be the distribution network because the transmission network is already quite smart at least in Finland. (Elovaara & Haarla 2011b, 513.)

Smart technologies do improve the observability and controllability of the power system. Smart Grid technology is a new type of power grid where the communication between energy consumption and the energy provider plays an important role. Thereby, the technologies of the Smart Grid convert the power grid from a static infrastructure operated as designed to a flexible infrastructure operated proactively. In the Smart Grid the needed energy can be directed more efficiently and the information of energy consumption is more accurate. The areas of the Smart Grid is seen in figure 2. (IEC 2010, 13.)

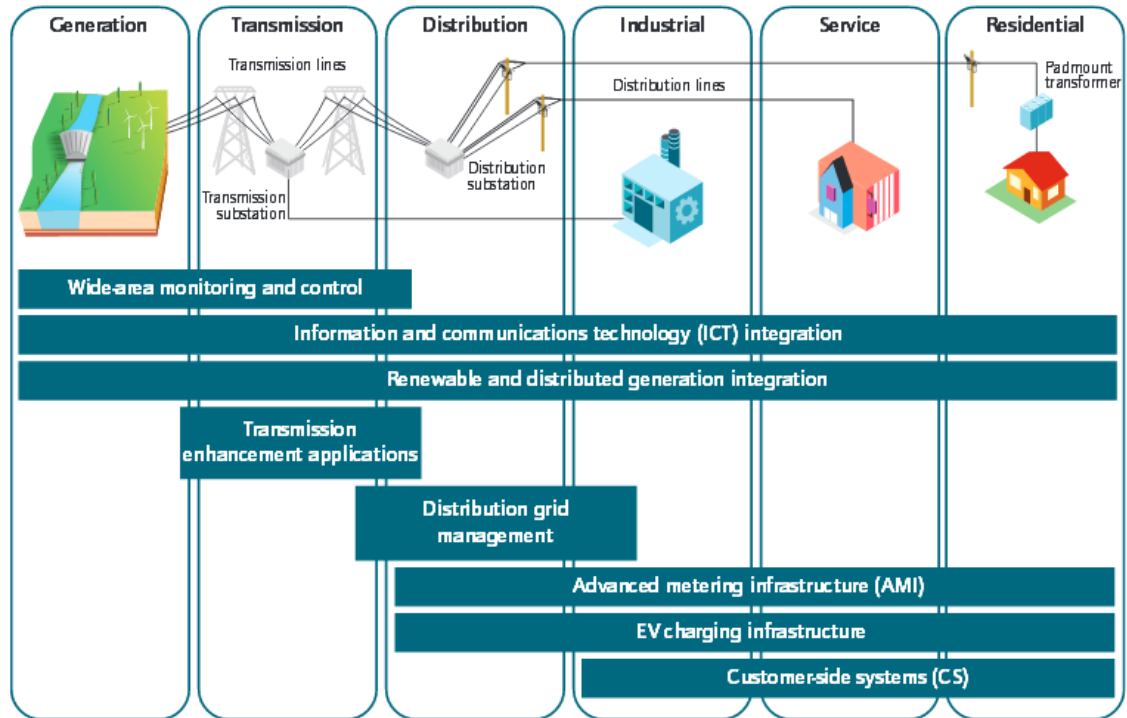

Figure 2. The Areas of the Smart Grid Technology. (IEA 2011, 17.)

Traditionally, energy systems from power generation to homes are one-directional and based on more predictable, controllable and centralised power generation where electricity is generated at the same phase as it is consumed. There is very little elasticity in the traditional grid as the generation adapts to fluctuations. (EDSO 2016.)

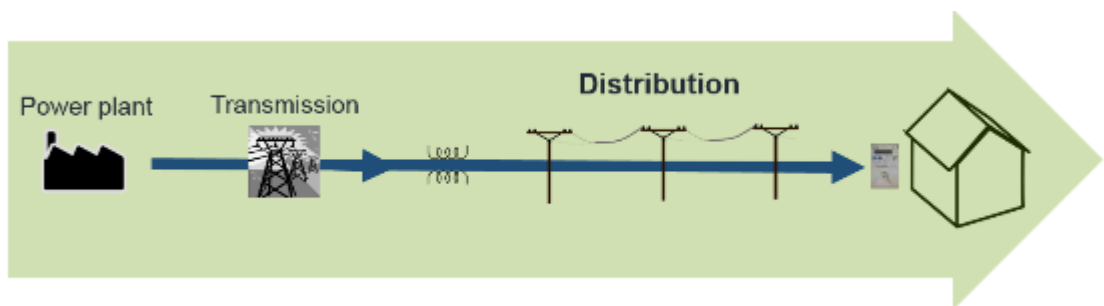

Figure 3. Traditional Power Grid (EDSO 2016.)

Instead of the one-directional system shown above in figure 3, distribution networks are starting to look more like shown in figure 4, where there are more options to regulate the electricity generation. The overall vision and the roots of the Smart Grid would seem like in figure 5.

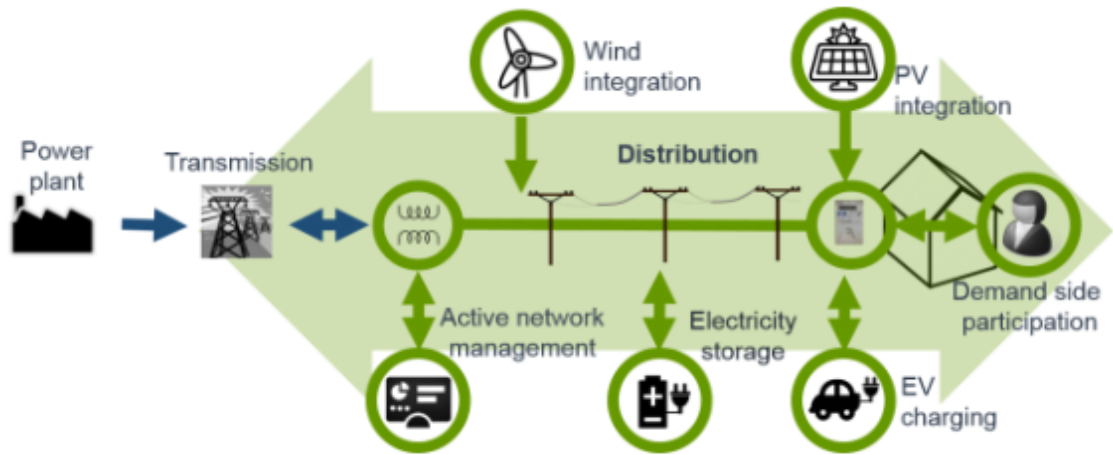

Figure 4. Smart Grid Vision (EDSO 2016.)

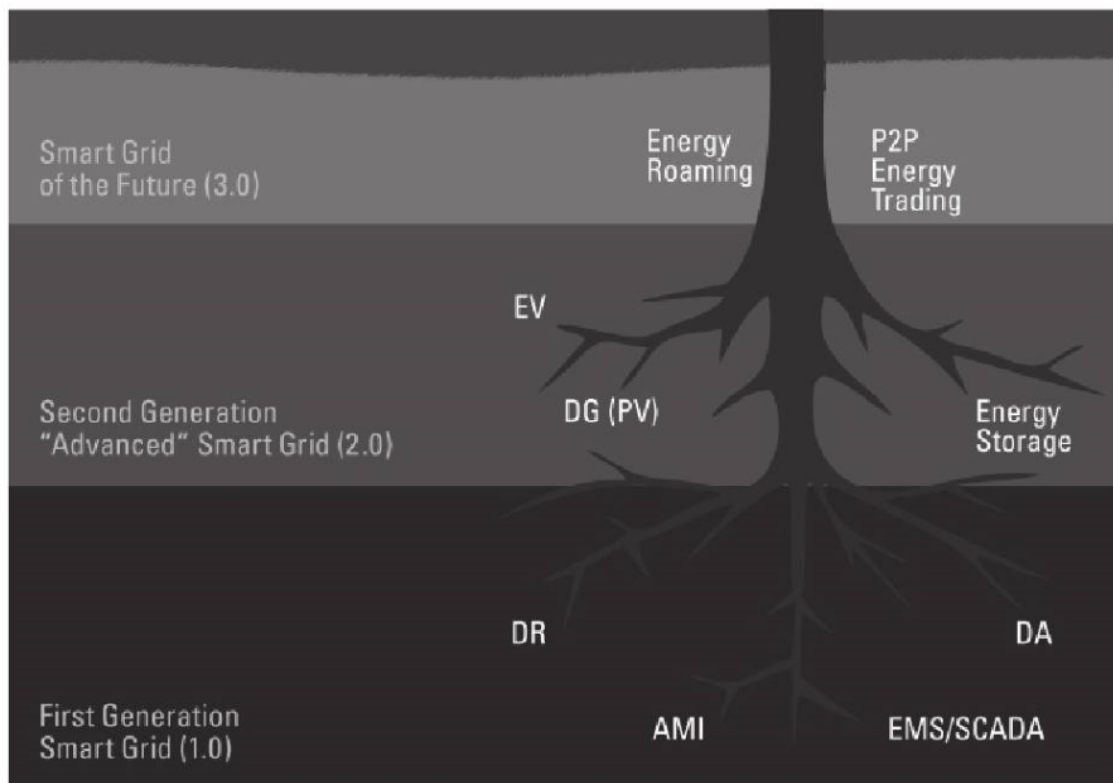

Figure 5. The Roots of the Smart Grid (Carvalho, A., Cooper, J. 2011, 8.)



There are many reasons behind developing the Smart Grid. When we want to prevent climate change, increase energy efficiency and better energy supply a new type of power grid is needed. This will require innovative products and services to go along with intelligent monitoring, control, communication and self-healing technologies.

The main point in developing the Smart Grid comes to activating the consumers and customers to participate in overall energy consumption. When the customers become interactive it creates elasticity to the electricity markets. It is very essential that the customers are able to have easy-to-use and even automatized electrical services and have a chance to affect their own energy consumption. It is even more important to create a feeling to the customers that their participation is beneficial for them e.g. the price of electricity, reliable supply etc. In Finland almost every usage point has at least a remote reading meter installed. There are even applications to follow up the electricity market prices up to an hourly level or even a minute level. (Huttunen, R. 2014.)

In order to work properly the Smart Grid needs new and different business models especially information and IT based services and energy efficiency services. It is important to make sure those services can form from a competitive market base. New business models are developed by “smart energy –idea competition” in Finland by TEKES and through the research program by CLEEN. (Huttunen, R. 2014.)

#### 2.4 Communication in Smart Grid

In the Smart Grid, the communication between the different components of the grid becomes crucial to work efficiently. It should be seen as a supporter of the power grid and not as an end solution itself. Communication has been used in Power grid since its inception and the role of the communication use in the Smart Grid is increasing. The question comes to what is actually enabled. Is there something fundamentally new or simply improving the ideas that have been around already? (Bush 2014, 185-187.)

The benefits the communication in the Smart Grid provides are e.g. an advanced warning system and remote control. There are plenty of different solutions available regarding communication technologies and applications within the power grid. One of the challenges developing the Smart Grid has been how to define a detailed architecture because there are countless detailed communication standards available. The architecture of a communication network can be quite loose when it becomes to simply specifying its framework for the different aspects of it. This can include components of the network, their functional organization and configuration. (Bush 2014, 216.)

One of the biggest factor, which goes against a detailed and optimized communication architecture, is that communication evolves in such a fast phase. In no time, most of the electricity providers' budget must be redirected upgrading the existing communication solutions of the power grid that are already out of date after the update being complete. (Bush 2014, 218.)

No one can really predict all the new Smart Grid applications that might be developed in the future. Only a fraction of early applications has been identified and taken in use so far. There are many different applications to list but in figure 6 can be seen a subset of some of the selected applications. (Bush 2014, 199.)

Information theoretic technics can lead to better power demand predictions and to a better response. As better stability control is derived from the network analysis, it can benefit distributed generation as stability in general will improve from it. Network coding which combines network analysis with source coding may have potential to reduce traffic load for AMI (Automated Metering Infrastructure) and other applications. Cybersecurity within the Smart Grid applies theories of entropy and quantum information. Optimizing the use of energy storages, entropy and prediction will apply to it. Energy storages are used to help reduce peak demand for power. When power demand is smoothened, reducing its entropy is equivalent to it. When the power grid reaches down to a nano-scale it brings new kinds of challenges in which every joule of energy is harvested. When the molecular level is reached it will require new forms of communication which are capable of operating at the molecular level. (Bush 2014, 200.)

Concept	Smart grid application	Benefit
Classical channel capacity	Throughout the smart grid	Decrease load
Classical compression	Synchrophasors	Phasor data compression
Compressive sensing	AMI	Decreases meter load
Entropy	Security	Increase encryption strength
Entropy & prediction	DR	Predict power output
Entropy & prediction	DG	Smooth peak demand
Entropy & prediction	Energy storage	Reduce variance
Entropy & prediction	stability	Channel coding
Inference	State estimation	Inferring state with less data
Nanoscale communication	Nanogeneration, nanogrids	Control power grids comprised of large number of very small components
Network coding	AMI	Efficient transmission
Quantum information theory	Security	Quantum key distribution
Spectral graph theory	FDIR	Distribution network analysis
Spectral graph theory	Power grid and communication networks	Network structures
Spectral graph theory	Grid-communication networks	Network structures
Entropy	Security	Encryption strength
...	...	...

Figure 6. Information Theory and Network Analysis (Bush 2014, 199.)

It can be thought there are two kinds of network topologies: the topology of the power system and the topology of the communication network. The first one can include generators, loads and power lines. The second one includes communication channels, transmitters and receivers. There are some communication technologies that are to follow the topology of power grid and some have freedom to deviate from the topology of power grid. Short-range wireless systems are a great example. There are even technologies that are completely independent for example the ones utilizing a telecommunication company or common carrier to implement communication. (Bush 2014, 188.)

A protection mechanism illustrates an impact on the topology. There might be a segment in the power grid that needs to be isolated when an electrical fault occurs while at the same time the impact of the fault should be minimized in order to ensure the flow of power to consumers. To be able to operate as quickly as possible, communication latency must be low. From a communication perspective, topology has a critical role when it comes to the communication media and how

it is shared. The efficiency of routing through the network plays also an important role. (Bush 2014, 188.)

When it comes to considering the interaction of power system applications and communication such as stability, switching, automatic gain control, load balancing, protection or state estimation it comes down what is fundamental and common regarding power systems and communication. Could there be a new power system theory to be discovered and what would it be or how it would change the core nature of the power grid? Traditionally the technology of power system has been fundamentally concerned with the dynamics of electromagnetic fields. This can be found in such components as generators, transformers, capacitor banks, inductors and loads. These dynamics are captured in Maxwell's equations. Also in higher level simplifications e.g. as Kirchoff's laws. Communication and power systems have parted their ways long ago. One focuses on optimizing power transmission and the other optimizes information transmission. (Bush 2014, 189.)

## 2.5 Smart Grid 1.0 in Finland

Electricity grid in Finland is one of the most intelligent grids in the world. It allows to track down electricity consumption on hourly rate. In Finland, there is quite a lot of use of technology in the electricity network so therefore it can be said to be Smart Grid 1.0. The intelligent grid includes e.g. automatic fault locating and separation, optimization of network and remotely read meters. Most of the technology is positioned on the transmission network but the distribution network is also evolving. (Rytkönen, T. 2016.)

In a Finnish village called Sundom located in Vaasa there is a pilot project developing Smart Grid which consists of some of the biggest energy operators in Finland such as ABB, electric utility company Vaasan Sähkö, the ICT sector company Anvia and the University of Vaasa. The purpose of the project is to develop, test and process the most recent technology solutions for the Smart Grid. The goal of the project aims to make the electricity delivery more reliable and to create conditions for solar and wind power use in the region's households. (Energy Vaasa 2016.)

The project concerns the entire village of Sundom and holds population of 2500 people. New residential areas are being built as well. The power network in Sundom becomes more urban. It is a combination of overhead line network and underground cables. ABB tests the latest automatic fault management technology in this pilot. The earth fault management forms a key feature becoming more and more common when underground cables are gaining ground. Another goal focuses on building solutions that promote the use of renewable energy production. (Energy Vaasa 2016.)

In Sundom Anvia's comprehensive optical fiber the network makes the transferring digital measurement data in real time a possible feature. Anvia's data center collects all the data that is produced and it is available for all the operators involved in the project. Therefore University of Vaasa has an opportunity to study the features of underground cables and network automation. Their cost-effectiveness plays a big role in their study case. As a result consumers will get electricity in a reliable and optimally inexpensive way. (Energy Vaasa 2016.)

### 3 DISTRIBUTION OF ELECTRICITY

Bidirectional telecommunication is a crucial part when developing Smart Grid solutions. Smart metering is a one important factor. Then comes Automated Metering Infrastructure (AMI), which is one of the new outstanding features relating to Smart Grids. Automatic meter reading (AMR) has actually existed a long time. What this includes is manual techniques for example local serial interfaces, infrared or RFID. There are also fully automated techniques available such as early distribution management system (DMS) programs, which used old telephone systems for bidirectional reading and control. Bush states that in the end this is not actually such a new idea. (Bush 2014, 240.)

#### 3.1 Substation Automation

Substation automation system means a system that can provide an access to a power system locally or through a remote operation system. It enables local manual and automatic functions and takes care of the needed data transmission links, connections and coding the data into a form understood by different applications so communicating between the grid's control room and its systems and local actuators would be possible. (Elovaara & Haarla 2011b, 386.)

Traditional control of substations has mainly based on electromechanical devices and so called control-reset switches. Every field of substation has usually had fault shielded cabinet located indoors where all the data from the field and its devices has been collected. The data has usually been in an analog form. With the help of the local field information the control of the field, possible adjustments like the adjustment of voltage or production control of reactive power, protective security features of larger entities and event logging systems could be implemented. The data has been submitted to the RTU (Remote Terminal Unit) of the station, which has been at the station specifically responsible for suitable connections, coding the data into a right form and submitting the data to a SCADA system. (Elovaara & Haarla 2011b, 387.)

Today's substation automation system might have a more distributed structure and it takes care of a very large part of the automated functions related to the

station control. The system can be a network formed of devices based on micro-processors. The digital processing of data and handling at the station is possible when using this kind of devices. The digitization of data entails benefits such as aging of a processor does not distort the data, the data is obtained more accurate and it remains more accurate and transferring data in digital form is simple in serial form. Therefore, one optical fiber cable can be used instead of parallel galvanic cables. Increasing capacity of processing and memory enables even more versatile operational functions. Increased “smartness” also means a possibility to supervise and examine work quite independently, which betters the operational reliability and usability of the devices when the faults can be detected in an early stage. The same output data can now be processed in different ways as before the needed data had to be brought for each actuator separately through their own conductor pairs. (Elovaara & Haarla 2011b, 387.)

There are also problems when digital technology is coming in use. Engineering substations also require know-how in engineering communication systems. Especially processor shielding needs enough attention. Also time-based data updating forms more complicated because there might be coming updates in the same object simultaneously which cannot be accepted. The lack of international standards causes risks where users must use the same product because other manufacturers' product is not necessarily compatible with the earlier product. The change and development in digitalization technology is so fast phased that purchased products can be outdated in a couple of years. This can cause the lack of spare parts and products. (Elovaara & Haarla 2011b, 388.)

### 3.2 Smart Metering

Sometimes the term Smart Grid and smart meters are confused by people. Smart metering is a great example improving customers' possibilities to influence their energy consumption. The smart metering refers to a subset of a Smart Grid and is one possible application that constitute the Smart Grid. Smart meters are one of the most important solutions to allow two-way communication. (Rytkönen, T. 2016.)

These meters among other things enable the households to equip their own units to follow the use of electricity. These units help to understand the usage of used electricity and track down electricity gluttons. This information is helpful to get real information about the energy consumption and construct electrical bills. In the future households and electric grids are so intelligent that they are able to adjust themselves to be energy efficient. (Caruna 2016.)

Since the beginning of 2014 almost every household in Finland is equipped with remote meters. This means that the readings of the remote meters are not needed to inform the energy provider but the information is delivered through a data transfer connection. (Caruna 2016.)

Even though Finland is a country that has been a forerunner in equipping households with remote meters, electric companies have needs to change soon-to-be-outdated remote meters to newer models in a next few years. It is estimated to cost around 700 million euros if the price of the meter is assumed to be 200 euros and 3 million pieces are needed. The investment unfortunately will be seen in the customer's electricity bills although it is divided into the period of 15 years. (Pietarinen, H. 2014.)

Technical life of the meters is approximately about 15 years because of the new technology. The usage age of the first meters will be fulfilled at the beginning of the 2020 says Kenneth Hänninen, the manager of Energiateollisuus ry. It is said that the lifespan of the meters is relatively long if compared to IT technology or even smart phones. (Pietarinen, H. 2014.)

Landis+Gyr is the leading company on the globe in metering solutions for electricity, gas, heat/cold and water for energy measurement solutions for utilities. Its worldwide locations are in Asia Pacific, Europe, Middle East and Africa. Also North and South America are included in Landis+Gyr's territory. (Landis+Gyr 2016.)

Most of the smart meters of Landis+Gyr use wired data transfer. The measurement data is transferred from the consumer into the transformer substation's hub through a power line in the allowed frequency rate defined by the EU standards.



Transferring the data, the EU's adequate DLMS protocol is used. EN-SFS standard 50065-1 defines the powers and other values of the used signals precisely. (Turun Energia 2016.)

Almost every electrical usage place in Turku Finland has already a remote meter installed as seen in figure 7. The remote meters are manufactured by Landis+Gyr. The meter models E450-1 and E450-3 are the most popular ones of all the installed smart meters. There are other models as well including, E550, E650, E120LiME, ZCF100, E350-1. (Turun Energia 2016.)



Figure 7. E450-1 and E450-3 (Turun Energia 2016.)

E450 is a new system component for the Landis+Gyr AMM solution. It is an advanced Meter with an integrated PLC modem for residential use. It integrates four functions in one device, which are a multi-energy data collector, an extremely flexible advanced electricity meter, a remote two-way communication node and a powerful interface which enables end user interaction. (Landis+Gyr 2016.)

Oulun Seudun Sähkö (OSSV) made a contract with Aidon in 20.1.2010 for a delivery of smart meters and a compatible reading system to OSSV. OSSV delivered and installed smart meters to every 27 000 electricity usage point of its district. Aidon had to offer a control system for a low-voltage network that the other distributor did not have at the time. (Aidon Oy 2010.)

OSSV is using the Aidon Gateway reading system. Aidon Gateway is integrated with the Process Vision customer information system and ABB's operation support system. The reading and control information produced by the systems can be used by the customer service and grid management. As it comes to smart meters the models Aidon 551X and 5530 are in use at OSSV as seen in figure 8. They are 3-phased kWh-meters with a remote control device. (Oulun Seudun Sähkö Oy 2016b.)



Figure 8. E5530 (Jönköping Energy 2016.)

Remote reading is usually based on wireless communication and there are several technologies used. In short distances the communication is based on 856 Mhz Mesh-radio and longer distances 900, 1800, 2400 Mhz 2G/3G networks. Mesh-radio is a transmission technique designed and approved for meter reading. 2G/3G network means public GSM/GPRS cellular network. (Oulun Seudun Sähkö Oy 2016b.)

The software collects the reading info via GPRS connection from the smart meters consisting of a smart meter with a communication bus, a system module and a remote connection device. Either a solid RS-485 bus cable or a MeshNET-radio connection is used for communication. (Oulun Seudun Sähkö Oy 2016b.)

### 3.3 Network Automation Technology

Several systems are needed for distribution management. The systems process information gathering, handling, recording and transmission. The next chapter

introduces some of the systems that are in interaction between distribution automation info-systems.

### 3.3.1 Information Systems

The overall AMM systems (Automatic Meter Management) varies depending on the power supplier. The AMM systems in Finland consist mostly of smart meters and concentrators, which are a communication hub, communication network and the network of electricity grid Company. By making use of the measurement data and load control possibilities provided by AMM systems it is possible to gain better control of a low-voltage grid but also a medium-voltage grid load and fault conditions, especially on a countryside. The load of the grid, status and quality of electricity can be known more precisely and when needed it is possible to control those via AMM system by controlling the loads. (Savolainen, P., Koponen, P., Nojonen, S., Sarsama, J., Toivonen, J. 2013, 23.)

The capacity of the electricity grid can be obtained more precisely and prevent component overloading. The grid faults can be detected faster and repairing actions are possible to start earlier. When the load of the grid is known better it helps targeting and timing the investment of the grid better. This way the usage of the distribution electricity grid transforms into more dynamic and complex when there are more distributed production, controlled loads and energy storages multiply. The requirements and challenges for security of electricity supply and quality of electricity gets tighter. That is where distribution grid management must be developed to be better through different information systems and control function. (Savolainen, P. et al. 2013, 23.)

### 3.3.2 Reading System

The Reading System is used to read the measurement data from remote meters or smart meters. Afterwards the data is read, verified and saved into a measurement database. The Reading System is used to read data from multiple different meter models using different communication busses and interfaces. There are several different practices to read the meters. (Savolainen, P. et al. 2013, 23, 25.)

The reading system can be managed by either a power grid company or a separate service provider. The same power grid company may use several different kinds of reading systems. The data is transferred through a secured connection. (Savolainen, P. et al. 2013, 25.)

### 3.3.3 Measurement Database

The measurement database is meant to save and storage meter readings. The meter readings come to the system from portable meter reading devices and other market participants via EDI system. Hourly readings, predictions and tariff measures customers' annual consumption forecast. (Savolainen, P. et al. 2013, 25.)

### 3.3.4 Distribution Management System

Distribution management system controls the efficiency and reliability of the electricity grid. It works as a support system for decision making for the operators. It offers ancillary functions for the grid control. (Savolainen, P. et al. 2013, 26.)

### 3.3.5 Network Control System

Network Control System (NCS) monitors the efficiency and reliability of the electricity network and collects real-time information from substations and networks. It also sends control data to the substations in the networks. It is used to store measurement and status information, parameters etc. Because the flow of measurement data is continuous the most recent data is stored in the system from specific timeline. On the other hand the system must also be flexible enough to connect different kinds of applications to it. (ABB, 6.)

### 3.3.6 Customer Information System

Customer Information System (CIS) contains information about the customer. It can be even considered one of the most important parts of an electricity plant. The economy of the plant and billing are based on the records of this system. The information is also used as a basis for evaluating the load. (ABB, 6.)

### 3.3.7 Systems Control and Data Acquisition

Supervisory Control refers to a system used to supervise and control the process of electricity distribution so that the balance between producing electricity and consuming remains. Practically it is a control system of the grid automation called SCADA. The system consist of servers, operators workstations including their software and the terminals located in the distribution grid, substations and the subsystems working under the SCADA system. It monitors the load, voltage and faults of the electricity grid 24/7. (Savolainen, P. et al. 2013, 26.)

As well in normal cases as especially fault cases control commands can be sent remotely to the substations. In order to keep electricity network working properly and remain intact the SCADA system becomes critical and therefore servers must be duplicated and secured with a backing power. Power grid has separated components from SCADA system to protect the grid from critical over voltages and loads. SCADA system cannot prevent all the possible faults so it might be possible to make contributory actions, which can lead overloading the grid, its components and even breaking them. (Savolainen, P. et al. 2013, 26.)

### 3.3.8 Network Information System

NIS system includes necessary functions and databases for deferred processing of the network containing technical data of electrical stations, medium voltage network, transformers and low-voltage network all the way to the customer's end. The principal functions of the system are for designing the network, maintenance and tracking calculus. (ABB, 6.)

### 3.3.9 Communication Technology in Smart Grid

In Smart Grid data transfer, it is possible to make use of almost every known technology but the most important ones are based on wireless data transfer. There are some of the most common data transfer methods used in mid and low voltage network. (ABB, 7.)

Local Area Network (LAN) is the most effective solution of distributed system. The communication network is currently being used in the nearby area stations,

which need an effective data transfer method for example town facilities. (ABB, 7.)

A radio link can be used to establish multiple speech- or data connections at the same time. Due its high purchasing cost, it is mostly used between a substation and a control room. (ABB, 7.)

Wired solid connection is rented from the holder of a telecommunication network or it is built and maintained by the builder. The connection form demands modems suitable for the connection. (ABB, 7.)

When Switched Telephone Network is used there must be a telephone connection in the object and a modem in both ends of the connection. Alongside the traditional modem solutions the ISDN technology (Integrated Services Digital Network) can be used. (ABB, 7.)

Public Data Network transmission services are purchased from telecommunication operator. The cost of the services depends on the transmission rate and distance. (ABB, 7.)

Talk Radio is commonly used to remote-control isolator stations in a way that a sound frequency control signal is sent through voice traffic. The method requires only a little extra investments for the electric station which already has a radio network usually. The data transmission usually requires a line of sight between the sender and receiver. Therefore, there must be base stations every 40 Km. In addition, the method is limited by the necessary authorizations. (ABB, 7.)

A Packet Radio Network is also used in needs of network automation. The message jumps from sub-station to another. To avoid congestion it is defined that sub-stations may send information only on request. In this case the station in the center of the grid has to transfer all the traffic through it and there can be only one message at a time. (ABB, 7.)

Distribution Line Carrier (DLC) in the distribution network is typically used to control the load and streetlights. By developing bidirectional systems, DLC has more implementations in automated meter reading. The used frequencies are 1-10

kHz. The data transfer is traditionally managed with the same system in mid- and low-voltage grids. (ABB, 7.)

In a Hybrid System the traffic in a low-voltage network is carried out with a narrow carrier system. In this case all that is needed is a connection from a higher level to any point of transforming. (ABB, 7.)

Optical fiber is a standard solution in a substation's internal information transfer, the grid's transmission lines, and trunk routes of telecommunication networks. Nowadays Optical Fiber is usually installed in the ground in connection with the installation of other cables to wait further use. (ABB, 7.)

### 3.3.10 Aidon Oy AMM Solutions

Aidon has to offer a full-scale automation systems for the Smart Grid use shown in figure 9. Aidon uses smart AMM system, which can be integrated with the DSO's information systems. This opens a detailed real time view into the supply quality of low voltage network, and metering point locations. If the AMM system is extended to cover distribution substations, an even more comprehensive overview of the grid can be obtained. (Aidon Oy 2016.)

Energy service devices installed in the points where electricity is consumed and in the distribution substations, serve not only as indicators but also as smart sensors that register the activity of low-voltage network and the use of the information site. For example a situation where the load and the possible interference caused by electrical appliances become faulty. Some of these recognizable faults and disturbances can include a phase loss, over- and under voltage, as well as 0-wire fault. The energy service devices convey the fault reading via the reading system into the information system of the energy provider. When the data of the fault and location is obtained almost in real time the repairing work can be started quickly and a greater damage can be avoided which results in minimized disadvantages to the customer. In addition to the consumption points when the smart metering system and PGM cover substations as well, quality electricity supply can be provided to cover the entire low voltage network. (Aidon Oy 2016.)

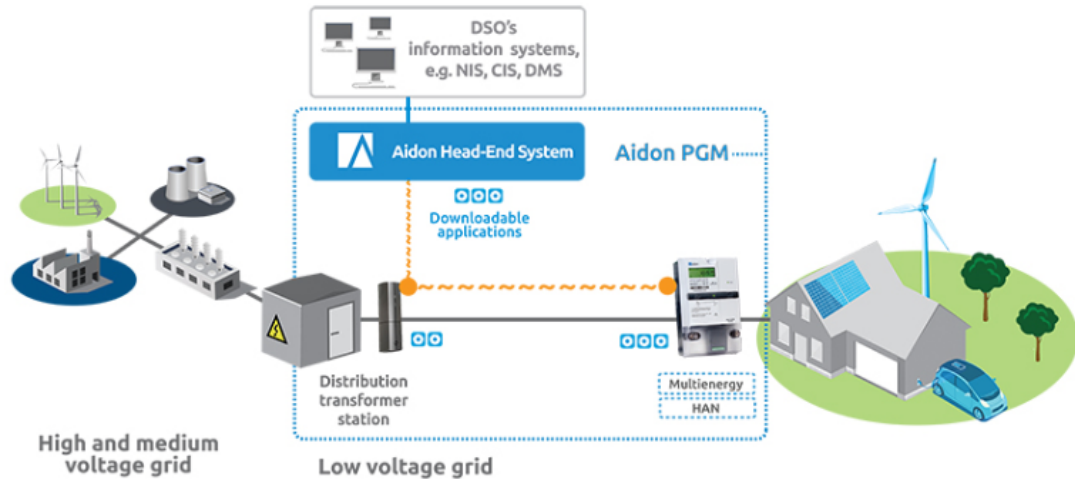

Figure 9. Automation System by AIDON (Aidon Oy 2016.)

### 3.4 Methods of Data Transmission

Implementing telecommunication services and networks increases through the use of data transmission at home or work. Network companies have strived to implement them as their own networks. Some of the reasons are that a great usability is demanded from the companies' networks especially during electricity faults and errors. Breaking into a separate network is more difficult than into a public network. During a public network fault condition the network companies cannot have the priority of transferring their own messages and recover the networks to function properly. (Bayindir, R., Colak, I., Fulli, G., Demirtas, K., 500; Elovaara & Haarla 2011b, 404.)

The transferred data of grid companies can be categorized by the form of data and it based on the importance of the transferred data on controls, measurements, alarms and notifications. The information is transferred via a transmission path. The main features are a transfer rate, bandwidth, transmit time and transmission method, which includes the cables based on a wired or optical fiber, radio links and etc. Analog-based data transfer systems do not include an option to express or fix errors which interferences cause in the data transfer. Today more and more data is transferred via optical fibres. When the data is transferred via light it is possible to obtain very large bandwidths and transmission rates. They



do require two separate fibres because of the bidirectional transmission, in which case making a low loss branching is still difficult. (Elovaara & Haarla 2011b, 396.)

Public network connections might not be available to be used when needed. A better operation mode could be that different companies centralize only on their own core tasks for example electricity companies on transferring and distributing electrical energy and telecommunication companies managing telecommunication services. The data transfer implements of network companies include some of the generally used solutions such as galvanic wire connections owned by the grid company, (earth- and air cables), rented connections, power line carrier communication, radio link connections, radiophone connections. (Elovaara & Haarla 2011b, 405.)

GPRS data transfer is mainly used between a HUB and a remote reading system. The HUB collects the transformer-substation-specific measurement data, which is transmitted from contactless meters through the PLC communication technology. The HUBs are located in a substation and they are not located in the apartments of consumers. (Turun Energia 2016.)

Some of the Landis+Gyr smart meters include a GPRS module, which transmits measurement data directly to the remote reading system utilizing the GPRS data transfer technology. The module corresponds to a normal GSM phone. Some of the Landis+Gyr's smart electricity meters also use the RF Mesh technology, which is the same as local radio networks where the frequency 869400-869650 MHz is used. The radio communication transmit power of the meters and devices complies with the international standards. (Turun Energia 2016.)

### 3.5 Low Voltage Direct Current Distribution

In 2013 the Electricity Market Act that came into effect in Finland obliges network companies to improve the reliability of the electricity distribution significantly. The fulfillment of the requirements is estimated to need billions of additional investments by 2030, and the most of the investments is going to focus on earth cabling. At the same time it is appraised that the number of people in sparsely populated

areas is continuing to reduce and consumers' self-sufficiency in electricity is increasing as using renewable energy sources in micro-production and energy storages are becoming more common. (ENSTO 2016.)

Lappeenranta University of Technology has already been studying the power distribution system based on a low-voltage direct current (LVDC), shown in figure 10, for years with the industry of the area. The goal has been to develop a more cost-efficient alternative for the AC electricity distribution system to correspond the future requirements. During the research, the technology has proven to be effective in a real usage environment having economical potential. However, there is no industrial products and networks for a large-scale operational use so far. (ENSTO 2016.)

Comparing the power transfer capability to low-voltage AC with the superior DC power grid, in some cases even 30-40% of the current mid-voltage grid the current branch lines could be renewed with more budget low-voltage technology while renewing the power grid. The new generation's DC electricity distribution is new technology of the digitalizing world. ICT, electrical power adaption and power grid technology are blending into a system forming a mid-voltage grid via the associated transformer. This connects the rectifier, customer-access-points inverters and DC power supply between them, as well as the comprehensive ICT system. The change from the AC to DC in the public network does not require any actions from the customers' behalf. (ENSTO 2016.)

The power transfer capability of LVDC system is much greater than an AC-low voltage system. The changes in the voltage and disturbance of the supplying grid does not appear for the consumer due to the voltage adjustment implemented with inverters. The LVDC system enables to build larger low-voltage grids than AC-systems. This leads to shorter and simpler topologies constructing mid-voltage grids and therefore to a prominent savings in the whole network construction, operation and outage costs. Especially in sparsely populated areas shortening the vulnerable mid-voltage air cable network improves significantly the reliability of electricity distribution and survivability of large disturbances. (Partanen, J. et al. 159.)

The low-voltage DC electricity distribution naturally offers flexibility and controllability which would require additional investments if implemented in an AC grid. Electricity with good quality voltage is smoothly delivered to the customers and real time info can be offered, for example about consumption and electricity costs. With energy storages and micro-production involved, the local DC grid automatically continues its operation as an island-grid. Even though there would not be electricity in other areas of the grid. In the visions of Lappeenranta University of Technology, research group will build micro grid cells consisting of few tens of customers. Design Engineer Tomi Hakala from Elenia believes that the technology will open new opportunities for distribution network companies. "Our goal is to develop the DC distribution a competitive solution which can be made use of on a large-scale on the side of the traditional distribution network." (ENSTO 2016.)

The DC distribution is also recognized internationally in several research and development projects to have potential as technology to suit in many objects. The interest towards the possibilities of a public DC distribution is growing. "LVDC is a real Smart Grid. It enables among other things elasticity of demand on a level of a single consumer, connecting the production of renewable energy and energy storage in distribution network cost-efficiently. LVDC technology will be a new success story as long as we are in time to develop the concept to be a ready solution", says the leader of business area R & D and Product Management of Ensto Utility Networks Tommi Kasteenpohja. Ensto is responsible executing the devices for the pilot-system. (ENSTO 2016.)

Inverter technology and low-voltage DC distribution (LVDC) create new opportunities and improves the reliability of electricity distribution, reliability of delivering electricity, the quality of electricity and services, as well as cost-efficiency. Some of the core smart features are the trade and capacity based management of loads and the grid. The LVDC system with inverters is therefore a huge leap towards the Smart Grid infrastructure. (Partanen, J. et al. 159.)

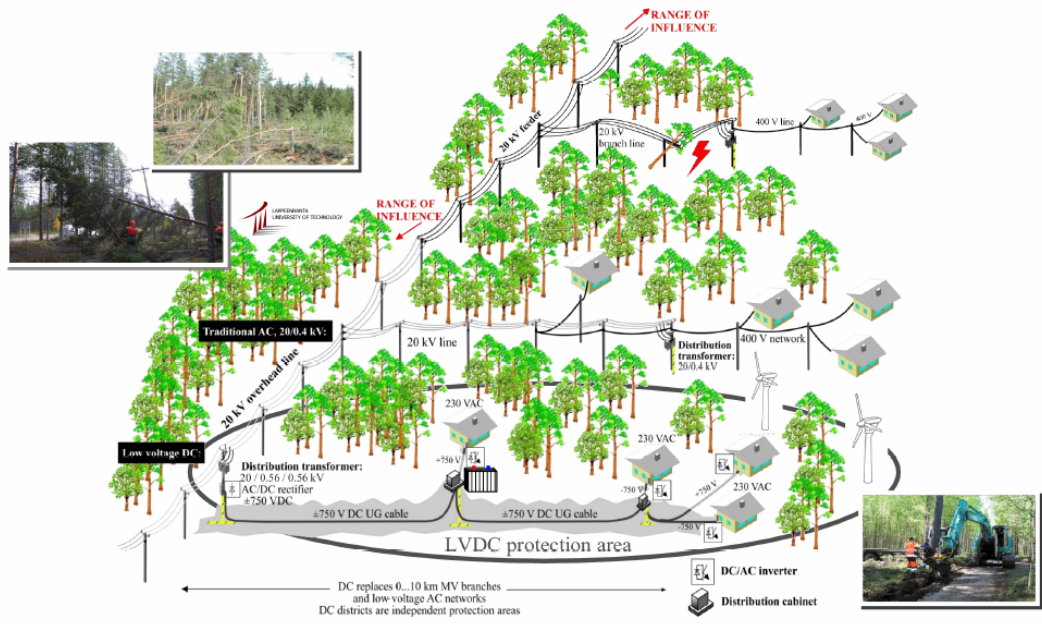

Figure 10. Concept of the LVDC Area. (Partanen, J. et al. 17.)

#### 4 SMART GRID SECURITY

Smart meters, data transfer infrastructure, and IT systems are essential parts of an electric grid. Attacks of malicious software focused on the electric grid and infrastructure, natural disasters and human errors can cause great damage. Ensuring error-free and safe operation of the electrical grid, effective protection on all elements, and levels are needed. The safety elements must be essential part of the architecture and must be noticed from the beginning of the grid design. (Kamstrup 2016.)

Vulnerabilities can be categorized into two groups: Designing errors and implementing errors. Designing errors are mistakes made in the design phase for example missing authentication in the commonly used remote-read protocol in a particular interface. Designing errors affect big group of devices usually and not only one particular model. Implementation errors occur because of programming errors made during the implementation. The most typical example of an implementation error is a buffer overload where a program records information from the outside of the allocated memory area. A typical attack is to try to cause a buffer overload by sending a particular type input to an interface listening the protocol. There are many interfaces in the AMM systems so it is important for the implementations to receive message traffic only in the right format from prearranged sources. (Savolainen, P. et al. 2013, 33.)

There are several different electric meters from different manufacturers in use in Finland. They communicate via several different protocols and interfaces. Some of the communication can be done via a third-party's commercial closed-form solution. Therefore, there can be typically different meters and reading systems from different manufacturers in the same distribution area at the same time. Remote Access Connections built for reading systems usage and management might cause security threads if implemented incompletely. The disparities of the solutions can cause compatibility and security problems. (Savolainen, P. et al. 2013, 34.)

#### 4.1 Communication of Meters and Reading Systems

Communication is encrypted when consumer information is transferred from the meters to the reading system. The encryption method is not usually mentioned publicly by manufacturers. This can also mean that the methods are not generally known. Usually the closed-end encryption protocols of the third parties have been more vulnerable than public, generally known methods. In some cases mutual communication between the meters is not encrypted at all. (Savolainen, P. et al. 2013, 35.)

Authentication Weaknesses are either design or implementation errors in the authentication protocol. For example a common password for all meters is easy to implement but carries a great threat if the password spreads publicly. If the data transmission gap is not encrypted, intercepting the password is possible. (Savolainen, P. et al. 2013, 35.)

If the communication between meters is implemented with a serial connection, it can be possible for the attacker to eavesdrop the communication and even send individual traffic. (Savolainen, P. et al. 2013, 38.)

Remote reading meters, which do not communicate with a concentrator, have GPRS or 3G modem and a SIM card. The card is similar with the ones used in mobile phones. The card should be restricted to its own APN connection. (Savolainen, P. et al. 2013, 38.)

The denial of service attacks are one of the most common attacks towards information systems. They usually do not require much know-how but can cause noticeable problems. In the AMM solutions one of the most critical targets is concentrators. It communicates with the reading system via cellular network. In Finland harassment devices are illegal but on the internet there are websites for ordering one. (Savolainen, P. et al. 2013, 39.)

#### 4.2 Load Management

In many countries like in Finland remote connections and load management are done remotely. If security fails in these scenarios, it can cause a lot of damage in

wide areas which can be greater than leaked consumer information. In a worst case scenario wide area blackouts can occur, destruction of components by overload, fires or even loss of human lives. The probability for these scenarios are very small. Only by improving the security of the AMM systems cannot prevent the possibility that a possible attacker could successfully manage to disturb the electricity infrastructure. (Savolainen, P. et al. 2013, 49-50.)

#### 4.3 Privacy Problems

When remote reading is used, the consumer information transfers through several communication buses and is stored in numerous servers. Maintaining the privacy of customers is an important challenge. Even though a disclosure of the customer data of an individual client does not necessarily cause great harm but the reputation of the enterprise in communication chain is threatened. (Savolainen, P. et al. 2013, 36.)

There is information about the customer that is recorded in the network company's systems such as the name, address, the number of the usage point, billing information, contract type, tariff or consumption information. For intentional party it is possible to deduce the person's activity without visiting the site and make guesses if there are people in the apartment. By spying the electric company's consumption information it is possible for rival parties to get critical information about the production plant's capacity and utilization. (Savolainen, P. et al. 2013, 36.)

#### 4.4 Metering and Meters

The local connections in electric meters have risen interest among hackers around the world but the successful local manipulation of new meters has not been heard about in Finland. In most cases the physical access to the meters cannot be prevented. It is important that there is diagnostics to indicate if someone has broken into the meter, the connection to the electric network has changed or the communication of the meters network activity has been blocked or harassed. If the implementation and filtering of the alarm is poorly designed it

is possible that incorrect, unnecessary, or flood of alarms prevent the exploitation of alarm functions. (Savolainen, P. et al. 2013, 49.)

Typically there is an option to remotely update the software and parameters. If done incorrectly, updating the meters can become expensive. The origin of software updates and the correct operation of inspection and tests must be taken care of in every phases of the updating process. (Savolainen, P. et al. 2013, 50.)

There are vulnerabilities in every IT system but when the security is taken care of on multiple levels, the risks caused by vulnerabilities ease off. The motivation of an attacker to take advantage of the system shrinks when the probability of being caught is high. The remote reading of electric meters is only on its beginning worldwide so it is likely that the interest of hackers towards the new electric meters and systems associated to the meters will increase. Including information about any security vulnerabilities and instructions for their abuse spread very quickly via today's internet. Each remote-controlled meter is in the end of an automated meter management system's security from global availability. (Savolainen, P. et al. 2013, 51.)

Even though the bidirectional telecommunication is important in the Smart Grid, it also brings new kinds of security threads. In addition to smart meters, remote reading and management systems are formed from multiple communication networks and information systems and they are implemented individually in various ways. This adds challenges to the situation as well as the fact that there are many contraction parties. The network operators will require more collaboration to ensure the system security of the shared system. (Savolainen, P. et al. 2013, 49.)

Automated meter reading has brought multiple devices and systems around it. The measuring data is transferred straight from the consuming meter into the reading system almost always via mobile phone network. A small number of the consuming readings is still read via the public switch telephone network (PSTN) or the old way on the spot. The format of the consumer information is checked in a reading system and will be selected in a suitable format. Then the info can be used in different kinds of needs across all the information systems. (Savolainen, P. et al. 2013, 24.)



## 5 DISTRIBUTED GENERATION

As the distributed generation (DG) becomes ubiquitous, there is no need for the traditional power transmission. However, it is good to have a highly connected power network for increasing reliability and to draw power in an emergency situation. Distributed generation will also make the grid more resilient. In an ideal situation DG will prevent customers to be isolated from the grid when faults, natural or malicious occur. In this case DG will continue to supply electricity until the main power is restored. (Bush 2014, 261.)

Distribution generation includes a wide variety of electric generation where relatively small electric generators are spatially dispersed around the electric grid. This kind of electric generation faces challenges on managing the quality and quantity of energy. In distribution generation the power companies must interact with the standards and practices to ensure the supply of energy to consumers. (Bush 2014, 259.)

Distributed generators are mainly used to increase the reliability of the grid, improve efficiency and reduce the need of expensive reserve generators. This way it is possible to provide more renewable power sources. This also concerns grid stability as the number of distributed generators increase. Typically, distributed generators seek to track the frequency of the main power grid which is controlled by a large, centralized generator to keep a steady phase. (Bush 2014, 268.)

In the Nordic power system there are plenty of hydropower and thermal power, which are able to provide regulation at a slightly slower rate. This kind of regulation is important during summer and winter times, between day and night and even at the level of minutes. (Fingrid 2012, 3) Usually when PV system or fuel cells are used, an inverter is required to convert direct current they produce to alternating current. Other types of generators such as wind turbines do not necessarily require an inverter. However it is often more efficient to use inverters with these kinds of distributed generators as well. (Bush 2014, 268.)

In Continental Europe the volume of solar and wind power has grown quite quickly. As the energy flow changes and travels through different countries, the operation of power system has faced new challenges. However, there is a limit for the renewable energy production to grow because a power system which only contains renewable energy sources is not possible to work. (Fingrid 2012, 3.)

## 5.1 Micro Production

Distributed micro production is in a rising trend and it will be connected to the electricity network to an increasing extent. Cheaper prices in a small energy plants, customers will to decrease ones' electricity bill and renewable energy propagating and climate targets from the EU has increased interest in small-scale production. Little town houses, farmhouses and small businesses are able to consider producing their own energy mostly for their own needs. (Energiateollisuus ry 2016.)

Micro Production refers to small-scale electricity production devices up to 100 kVA which are connected to the property electrical grid. These include small solar panels or wind turbines whose energy is mainly used by the customer. (Oulun Seudun Sähkö Oy 2016a.)

Small-scale production refers to a higher capacity production hardware (>100 kVA – 2 MVA). The electricity gained from the small production is higher than the amount of Micro Production and it is usually produced for sale as well. (Oulun Seudun Sähkö Oy 2016a.)

Before purchasing a micro production hardware it is recommended to be sure that the production of the hardware and its connection method is suitable for the electricity distribution network. In Finland the equipment must meet the recommendation set by Energiateollisuus up to 100 kVA and voltage, frequency and island operation theft protection technical requirements in accordance of Germany requirement document VDE-AR-N 4015 2011-08 or micro production standard EN50438. (Oulun Seudun Sähkö Oy 2016a.)

## 5.2 Emergency Power

The most suitable emergency power plants are diesel-powered as gas turbine plants. Their start-up time is very short, a few tens of seconds and their peak power can be achieved in a couple of minutes. The investment cost of a diesel-powered plant is quite low and comparable with a gas turbine power plant. Although the diesel-power plant is cheaper to use than the same size gas turbine. (Elovaara & Haarla 2011a, 37-38.)

The diesel plants are rather slow-speed and many kinds of fuels can be used such as light or heavy fuel oil, natural gas or even coal dust. Their efficiency rate is about 40% but if the emissions are conducted to a kettle the heat may be used in other way for example producing district heating. This way the efficiency rate can rise up to 60%. During a short peak-load-time (less than 1000 hours) the diesel power plants are competing even with coal power plants in the economical use. (Elovaara & Haarla 2011a, 37-38.)

## 5.3 Small Scale Hydro Power

Locally produced electricity betters for example the reliability of electricity supply. Local small-scale power plants usually adapts to their environment so landscape and ecological effects are often small. The lifetime of the power plants is also long being around 60 to 100 years. Small-scale hydro plants are categorized into two size classes. The actual small hydro power plants whose power output is 1 to 10 MW and mini hydropower plants with a capacity of less than 1 MW. (MOTIVA. 9/2016.)

## 5.4 Solar Power

Solar power is one of the growing and leading solutions for renewable energy resources due the new and developing technology available. A direct approach to capture solar energy is using photovoltaic (PV) cells. The most popular PV technology is based on silicon solar cells. The sunlight makes charge carriers to move in solar cells and create electricity between the attached electrodes. (Finnwind Oy 2013.)

The problem is to develop solar panels with high enough efficiency, as the current solar cells are <15%, so that the other costs (cooling, support structures, adjustment, installation, tracking) would become reasonable. The cells should also be manufactured economically and last a long time. (Elovaara & Haarla 2011a, 39.)

In Finland there is a long period of dark time, which restricts the usage of the solar energy, and therefore the possible usage of the solar energy would only replace the usage of fuel. An actual capacity benefits cannot be calculated for it. A working solution would be multilayered thin cells made of amorphous pi equipped with radiation centering collectors. They have the best premises to make use of solar energy spectrum. (Elovaara & Haarla 2011a, 39.)

Solar panels can be connected to the electrical system either directly or via an inverter. If connected directly, the voltage level for solar panels must be suitable. For example if the solar panels produce 12 voltage direct current and up to 100 watts the appliances connected directly must be 12 voltage DC appliances and the combined output no more than 100 watts. (Petäjäjärvi A. 2015, 32.)

Usually an inverter is used to convert the direct current that solar panels produce to alternative current. In most cases the produced voltage is 230 and single-phased. If converted to three-phased current, more power is possible to get. (Petäjäjärvi A. 2015, 33.)

## 5.5 Wind Power

The amount of wind power and the number of wind power plants have heavily increased from the 1990 century. The most noticeable difference compared to other forms of electricity production is its variability. The power produced by wind power is proportional to power of three of wind's speed. Wind turbines work when the speed of the wind is 3 to 25 m/s. If the speed of wind increases notably, the turbines must be removed from the grid in order to avoid any damage. Today the threshold is around 25 m/s. (Elovaara & Haarla 2011a, 40.)

The issue of wind energy production is that the electricity must be produced for consumption needs also in windless times. The wind power can be a so called distributed energy production if the plants are small and they can be connected

to the distribution network. Big wind farms that produce several hundred megawatts cannot be called a distributed production. They must also be connected to the transmission network. In both cases the effects to the whole electric power system of wind power should be taken into account if the total power of the wind power plants is quite big in terms of the whole system. (Elovaara & Haarla 2011a, 41.)

## 6 INTEGRATING ELECTRICAL VEHICLES INTO SMART GRID

The power source of an electric car is an electric motor and the batteries work as an energy storage. In addition, the car needs a recharge system, either slow or fast. There are a few electric car models but the supply is predicted to increase gradually. The number of full-electric cars is forecasted to grow when new small and middle class models come to market. The recent development in battery technology and low taxation of electric cars help to speed up the spreading of electric vehicles. The purchase price is still rather high for an electric car and the markets are still developing. The range for the electric vehicles is still limited and in winter time the range can be even more limited. The charging station network for EVs, such as fast charging is also still under construction. (MOTIVA 10/2016.)

In the year 2020 it is estimated that the vehicle base in the world will be 40 million. Therefore, the technology and services related to cars and charging infrastructures are developing in a fast phase. When the capacity of EV's batteries will increase from about 20 kWh even up to 60-100 kWh Quick Charging Time or charging power must be increased correspondingly. The current power of Quick Charge is around 50 kWh. Increasing the power to a level of 150 kWh (High Power Charging, HPC) is going to bring challenges for energy system because the time of the HPC service demand takes place at the busiest time of the day. Usually the energy load peaks are during the same time. (Mäkinen, J. 2016.)

Nowdays in EV's charging there is slow AC parking charge taking advantage of the charging device mounted in the car and fast DC Quick Charge. One of the future scenarios is that CSS (Combined Charging System) will be coming to use everywhere in Europe. (Mäkinen, J. 2016.)

### 6.1 Vehicles as Part of the Grid

When an electric vehicle is plugged into a charging system, it becomes part of the grid. Therefore charging infrastructure is an important component. It creates the interface between the Smart Grid and electric vehicle. In order to bring these functions for the mass market the charging of an electric vehicle must be auto-

mated and the charging infrastructure has to provide functions that enable a harmonized integration of renewable energy. Smart management systems become crucial and needed for taking care of the dynamics and uncertainty, which are caused by solar panels and wind turbines. (Lameck, Gasto, A. 2016, 16-17.)

## 6.2 Sources of EV Battery Charging System

There are several battery charging system configurations available, which are Universal Battery Charging system, Stand-alone PV-EV battery charging system, Grid-connected PV-EV battery charging system and Grid-connected WTG-EV battery charging system. (Sujitha N., Krithiga S. 2016, 2.)

The charging system shown in figure 11 is a universal and conventional system where the battery is charged from the utility grid. Also renewable energy sources can be used to charge the EV battery without utilizing the power grid. (Sujitha N., Krithiga S. 2016, 2.)

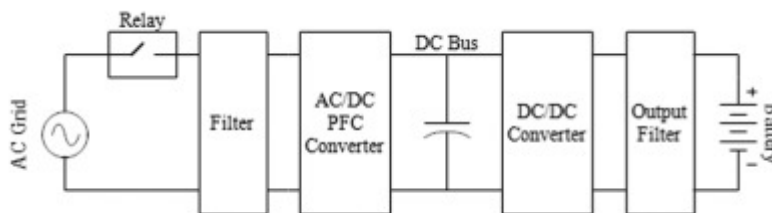

Figure 11. Universal Battery Charge (Sujitha N., Krithiga S. 2016, 2.)

PV stand-alone system in figure 12 is an off-board charger used for charging the battery without utilizing the grid power. Due to the intermittent nature of solar power it is necessary to have an additional battery storage in this configuration. Excess power from solar energy gets stored in the additional battery and is used to charge the EV battery when there are low irradianations. This system can be used as an on-board charger and without an additional storage battery. (Sujitha N., Krithiga S. 2016, 2.)

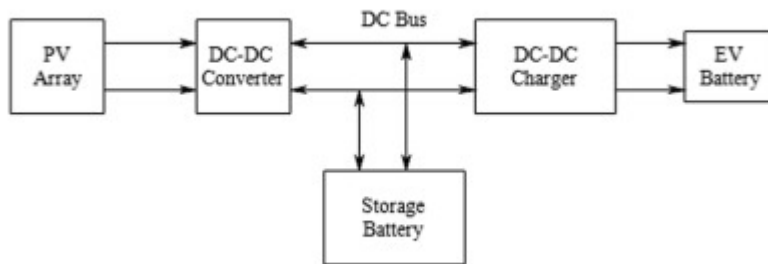

Figure 12. Stand Alone PV-EV Charging System (Sujitha N., Krithiga S. 2016, 2.)

The grid-connected PV-EV battery charging system in figure 13 is an off-board charger. This system charges the battery simultaneously and transfers the excess power from the PV system to the grid when sunshine hours peak. When the solar irradiation is low, the battery can also be charged from the grid. (Sujitha N., Krithiga S. 2016, 2.)

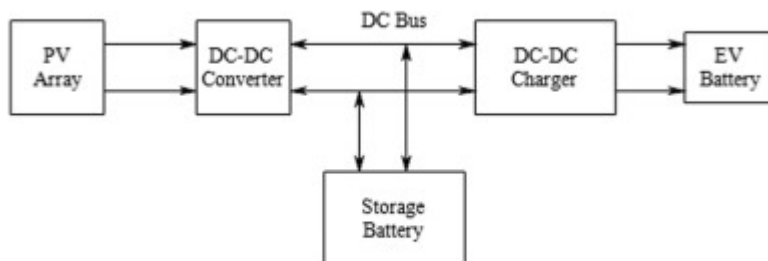

Figure 13. PV-EV Battery Charging System (Sujitha N., Krithiga S. 2016, 2.)

The grid-connected WTG-EV battery charging system in figure 14 acts as an off-board charger and employs the wind generator for charging the EV battery in addition to the utility grid. This system is similar to the PV charging system where there is a wind generator to inject power to the grid apart from charging the battery when there is a surplus of wind energy. (Sujitha N., Krithiga S. 2016, 2.)



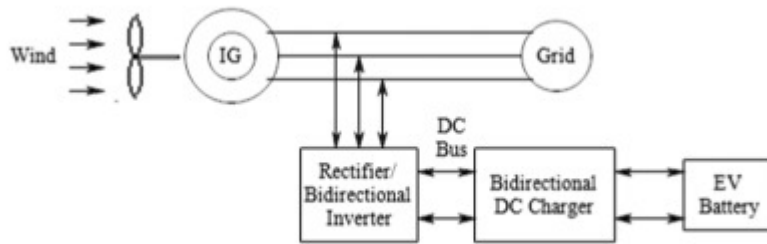

Figure 14. WTG-EV Battery Charging System (Sujitha N., Krithiga S. 2016, 2.)

### 6.3 Batteries in Electric Vehicle

Traction batteries that are able to handle high power and energy within a limited space and weight are usually used in electric vehicles. There are extensive research going on, on battery technology suitable for EV. Lead acid batteries are commonly used in EV. Although they are being replaced by nickel batteries which have high power density and reliability. Nickel batteries do have a problem of high self-discharge and heat generation when the temperature gets high. (Sujitha N., Krithiga S. 2016, 2.)

Lithium batteries are preferred and they have high power density, light weight and size. The batteries do not have the problems of low specific energy, poor temperature characteristics and chemical leakage. They have a long life cycle, fast charging capability, and low self-discharge rate. They also have a wide range of operating temperature. (Sujitha N., Krithiga S. 2016, 2.)

### 6.4 eBus System

VTT coordinates an eBus system project where an automatic charging system is piloted in Espoo Finland. The main goal of the project is that electric busses and their charging infrastructure can be built as cost-effective as possible. The automatic charging system must be tested in Finland's environment at first so the experience from the use can be obtained. (VTT 2014.)

Practically the charging is carried out by the pantograph mounted on the roof of the bus. In the terminal or bus stops along the route, there is a power supply point for charging, which is about 3 meters in height. For example with 2 minutes and 200 kilowatts charging the bus can be driven about 6 to 8 kilometers. The needed number of charging points and times depend on the battery of the busses and dimensioning the battery charging power as well as the length of the route. (VTT 2014.)

## 7 ELECTRICITY STORAGE

As renewable energy sources such as solar and wind power are becoming more popular in the trade of electricity and have intermittency flexibility the option needs to be implemented to balance the supply and demand. One flexible option could be electricity storage systems such as grid expansion, conventional energy generation, demand side electricity import/export and management. Therefore, storage technologies become more important when there is high shares of renewable energy. In the past decade there has been several electricity storage technologies that have been developed and applied. (Jülch, V. 2016, 1594.)

The pumped storage hydroelectricity (PSH) has been in use for a century and it is one of the best applications for the positioning force. The compressed air energy (CAES) plants are also used. Stationary battery storage technologies has entered in the market recently and Power to Gas (PtG) has reached a demonstration level. As the battery storage technologies have gained momentum in the market the economics of storage technologies are becoming into focus. Although the prices of the storage technologies are difficult to compare due to the differences and technical diversity in applications. (Jülch, V. 2016, 1594.)

In the future batteries might be used as an energy storage to even the load peaks and also add capacity to the electric network. When the electricity consumption is low, the price of the electricity usually lowers too which makes the recharge of the batteries cheaper during this time. Later on when the consumption of electricity peaks, electricity can be used from the batteries to support electricity distribution.

### 7.1 Pumped Hydro-Power

One of the most common type of energy storage is the pumped hydroelectric facilities. Gravity plays a powerful role and underpins this energy storage technology, which is employed throughout the world. The technology relies on a very simple technology where water rushes through a turbine that creates electricity. (ESA 2016.)

The material that is used does not have to be water. Some companies are creating gravitational systems that use gravel which is moved up the side of a hill and use the same principle as hydro power plants. When more energy is needed the gravel is released and channeled through a turbine, which creates electricity. (ESA 2016.)

By building dams storage pools can be built which enables a higher falling height for water and adjust the usage of energy. The water is stored in the pools and is used while electricity demand peaks. The water is channeled through the turbine from the storage pool to a lower level as is seen in figure 15. The type of the turbine depends on the size of the plant, falling height, and other conditions. Francis and Kaplan are the most used types of turbines and they are used in plants where the falling height is equivalent to mean. Pelton turbines are usually used at plants where the falling height is greater for example Norway and Alps. (Vattenfall 2014.)

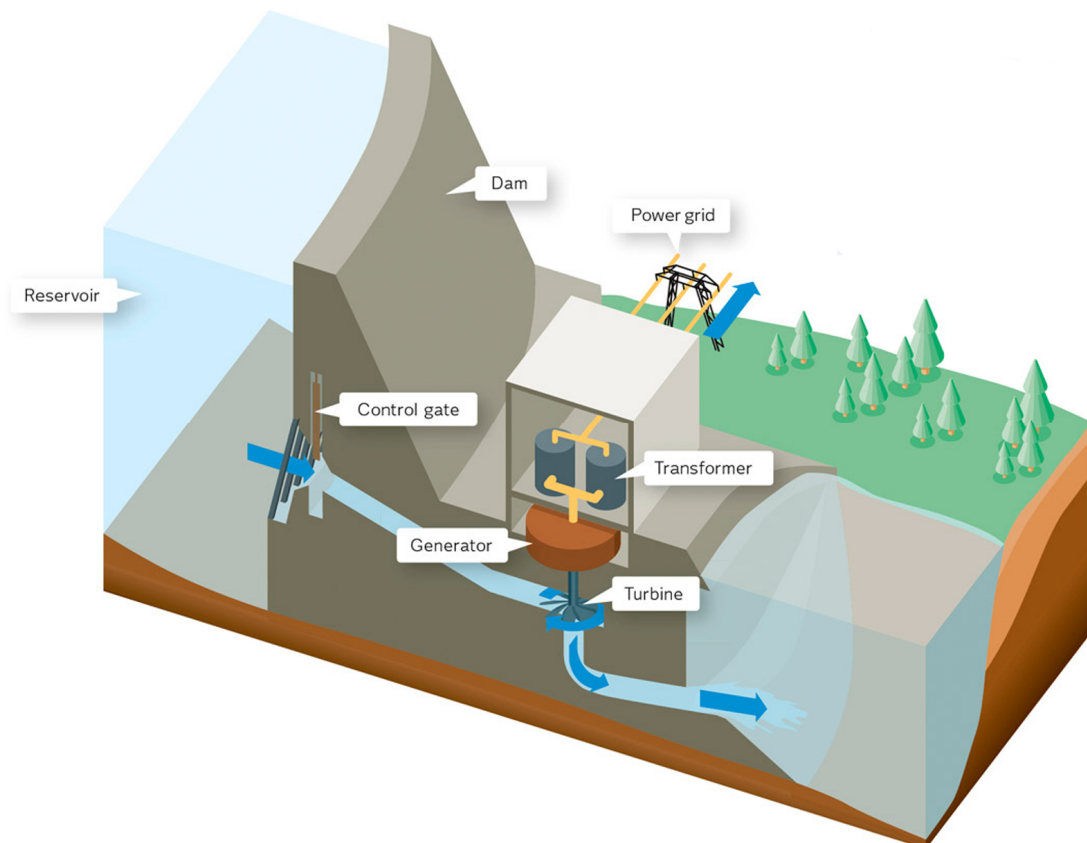

Figure 15. Big Dams Are Able to Store Water for Later Use. (Vattenfall 2014.)

The capacity of the overhead pool does not usually last more than 2-3 hours at a time. Tidewater, log-floating, fishing and recreation use set limitations for running the water. (Elovaara & Haarla 2011a, 38.)

The hydro power plants are the most reliable part of the electricity grid and they are mostly used for adjusting the grid power. The costs of the plant mostly consists of fixed costs such as purchasing the plant and building the pools. The costs pay back in about 40 years. The changing costs are minimal due to the “fuel” being free and the plants being remote controlled. (Elovaara & Haarla 2011a, 38.)

The idea behind Storage Hydropower is to level out the electricity consumption peaks. Storage hydropower is used when there is excessive consumption of electricity and too little electricity to provide the consumers. When the peak is gone and the normal electricity production is enough to provide the needed energy the hydropower will be shut down. On the other hand when the price of electricity is low the lowered water is pumped back up in the storage pool of water.

Pumped Storage Hydropower is the only kind of storage for electrical energy that is economical to use. Pumped Storage Hydropower converts stored potential energy to electricity. Pumped Storage Hydropower is considered to be the most economical way to storage energy with almost 70% efficiency.

## 7.2 Solid State Batteries

On its basic level a battery is a device consisting of one or more electrochemical cells that convert stored chemical energy into electrical energy. “Each cell contains a positive terminal, or cathode and a negative terminal, or anode. Electrolytes allow ions to move between the electrodes and terminals, which allows current to flow out of the battery to perform work.” (ESA 2016.)

The reliability and output of modern battery system have increased greatly as technology and materials have advanced. Innovation that has been continued has brought new technologies such as electrochemical capacitors. They can be discharged and charged simultaneously and instantly. With a solid-state electrolyte there is no degradation so they can provide an almost unlimited lifespan. (ESA 2016.)

Electrochemical capacitors (ECs) which are sometimes referred to as “an electric double-layer” or go under names like “Super capacitor” or “Ultra capacitor.” They physically store electrical charge at a surface-electrolyte interface of high-surface-area carbon electrodes. (ESA 2016.)

They have two kinds of designs. One is symmetric design where negative and positive electrodes are made of the same high-surface-area carbon (ESA 2016). The other is an asymmetric design where the two electrodes are made of different materials one is made of high-surface-area carbon and the other of a higher capacity battery-like electrode (ESA 2016). The symmetric ECs have their energy values up to about 6 Wh/kg and higher power performance. The asymmetric capacitors design have energy value approaching 20 Wh/kg. They have differences in other characteristics as well which leads to the use of the two types in different applications. (ESA 2016.)

Other technologies are Lithium Ion (LI-ION), Nickel-Cadmium (NI-CD) and Sodium Sulfur (NAS) batteries. The first commercial lithium-ion battery was released by Sony and Asahi Kasei in 1991. In the early age they were used for consumer products. Now many companies are developing larger-format cells for the use in energy-storage applications. Some are expecting a significant use of LI-ion batteries in electric vehicles. (ESA 2016.)

After electrochemical energy storage Nickel-based batteries (Nickelcadmium, Nickel-metal hydride, Nickelhydrogen and Nickel-zinc) are the most used batteries. Nickel-cadmium (NI-Cd) is a traditional type of battery. They provide simple implementation and do not need complex management systems. They provide long life and are reliable at service. To remain viable the battery type has seen advances in electrode technology and packaging. The future focus on development of the battery is to increase its' cycle life, reduce self-discharge and extend the temperature range. They will continue to be irreplaceable in their established applications due to their performance, operational safety and reliability. (IEC 2011, 21; ESA 2016.)

NGK manufactures Sodium Sulfur (NaS) battery systems for stationary applications. The systems operates at high temperatures ranging from 300 to 350 °C.

This can cause operational issues to intermittent operation. The system's efficiency is around 90%, which gives a real efficient use of energy. (ESA 2016.)

### 7.3 Flow Batteries

The re-chargeability of Flow batteries comes from two chemical components dissolved in liquids. The liquids are contained within the system and they are commonly separated by a membrane. Flow batteries can be almost instantly re-charged just by replacing the electrolyte liquid. The spent material can be recovered for re-energization simultaneously. (ESA 2016.)

There are different kinds of Flow batteries such as Redox Flow Batteries, Iron-Chromium (ICB) Flow Batteries, Vanadium Redox (VRB) Flow Batteries and Zinc-Bromine (ZNBR) Flow Batteries. The difference between flow cells and conventional batteries is that the electrode material in the conventional batteries is replaced by an electrolyte in flow cells. (ESA 2016.)

Redox flow batteries offer great flexibility to energy rating and independent tailor power rating as electrochemical means for storing electrical energy. They are economical, have low vulnerability and can store energy at the grid-scale. Redox flow batteries suit for energy storage applications from 10 kW to 10 MW and their storage duration is 2 to 10 hours. (ESA 2016.)

Iron-chromium flow batteries are still in the R&D stage. They have the potential to be very cost effective at the MW – MW hour scale. The energy in this kind of battery is stored by employing the  $\text{Fe}^{2+}$  -  $\text{Fe}^{3+}$  and  $\text{Cr}^{2+}$  -  $\text{Cr}^{3+}$  redox couples. The standard potential of the  $\text{Cr}^{2+}$  -  $\text{Cr}^{3+}$  couple is near the hydrogen evolution potential. The current developers are concentrating on their reliability. (ESA 2016.)

Zn/Br storage system that are up to 1 MW/3 MW hour have been tested on transportable trailers. The systems are also being supplied at the 5 kW/20 kWh Community Energy Storage (CES) scale. Zn/Br systems are being tested by utilities, mostly in Australia. (ESA 2016.)

## 7.4 Flywheels

Flywheels are rotating mechanical devices used to store rotational energy. At the basic level it contains a spinning mass in center that is driven by a motor. When energy is needed the spinning wheel drives a device that resembles a turbine to produce energy. The wheel's rate of rotation slows down and it is recharged by a motor to increase the rotational speed again. (ESA 2016.)

Flywheel technology has beneficial properties that enables to improve current electric grid. Flywheel is able to gather energy from intermittent energy sources and deliver a continuous supply of uninterrupted energy to the grid. They are able to respond to grid's signals instantly and delivers frequency regulation and improves the quality of electricity. (ESA 2016.)

FESS are well-suited to applications such as electric service power quality and reliability, longer term backup, fast area regulation and frequency response. The system can be used also as a subsystem in hybrid vehicles that start and stop frequently. (ESA 2016.)

## 7.5 Compressed Air Storage

Compressed Air Storage (CAES) is a technology where air is used as storage. Electricity is used to compress air and then stored in vessels or pipes that are either an underground structure or above-ground system. For pumped-hydro power plants CAES power plants are a realistic alternative. (ESA 2016.)

The compressed air is mixed with natural gas, burned and expanded in a modified gas turbine when energy is needed. Some of the typical storage options are caverns, abandoned mines or aquifers. This kind of process is called diabatic (dCAES) system. It results in low round-trip efficiencies of less than 50%. Another system is adiabatic (aCAES) system, which includes a thermal energy storage system. Two dCAES systems exist worldwide while an aCAES system is in the planning process (Jülch, V. 2016, p 1597). The technology is well-proven and the plants have a high reliability and can be started without extraneous power. The advantage of CAES is its large capacity. Some disadvantages include geographic limitation of locations and its low round-trip efficiency. (IEC 2011 2016, 18-19.)



## 7.6 Thermal

There are several kind of thermal energy solutions. Pumped Heat Electrical Storage (PHES), Hydrogen Energy Storage and Liquid Air Energy Storage (LAES). Thermal energy storage provides technology relying on temporarily reserved energy in form of cold or heat for use at different times. For example modern solar thermal power plants, which produce their energy from the sunshine during the day. The excess energy produced is often stored in these facilities. The stored energy can be used later in the evening to generate a steam to drive a turbine. (ESA 2016.)

## 7.7 Electric Traction Drive Shuttle-Trains

A Californian start-up company Advanced Rail Energy Storage (ARES) brings out a new and surprising energy-storage method for solar- and wind power for example. The problem with solar- and wind power is the periodicity of production. (Perttu J. 10/6.)

The new technology ARES is developing is gravity-based energy storage technology that provides significant stability to the electric grid. . The new technology combines modern power electronics with proven railroad technology. It raises and lowers heavy concrete containers filled with rocks embedded in sand. When there is plenty of solar and wind power the trains are driven up and when solar and wind fades out the containers are lowered back down by gravity. (ARES 2016.)

According to ARES, the electricity production with the trains is clearly cheaper than building pumped hydroelectric facilities and it does not need water. It can operate even in a desert where there is plenty of solar power. ARES uses recent advances in the other motor and generator traction drive, proven rail technology and power control technologies. This produces a system that approaches an 80% charge / discharge efficiency. (ARES 2016.)

The facilities are scalable and have a storage capacity from 100 MW with 200 MWh up to a 2-3 GW regional energy storage system with a 16-24GWh energy storage capacity. (ARES 2016.)

## 8 RESEARCH RESULTS

### 8.1 Smart Grid Enabling Effect on Energy Storage and Production

Battery storage technology research in the Smart Grid solutions is only gaining momentum. There are battery technologies enabling the Smart Grid solutions on a small-scale but the battery technology is not very effective on large-scale solutions, which could be applied to the electricity distribution and still be effective such as pumped hydro power. The technology is still rather ineffective or still expensive to be implemented on a scale which would be effective to even the peak loads of electricity network. According to Jülch (V. 2016, 1594) it is possible to expect the prices of battery technology to drop in the near future. Although the battery technology is used in EV solutions they are not in a state to use efficiently according to MOTIVA (10/2016). If the battery technology on EVs improves they could also be used to even the peak loads of electricity.

Even though the battery technology is not that effective on large-scale solutions but as the communication technology in the Smart Grid rises it brings new opportunities to use small-scale energy storages. For example if home automation increases it will bring opportunities to use battery technology in home use. Micro production is also able to use the battery technology. A suitable large-scale solution would be pumped hydro-power which is used everywhere where there is potential for it as Jülch (V. 2016, 1594) states. It is one of the most effective electricity storage and is mostly used to even electricity usage peaks.

As stated in chapter 7 the energy production of renewable energy sources are in focus in the Smart Grid solutions. The growing number of wind power and solar power sets new needs for electricity network in order to integrate solar and wind power into the electricity network. As the communication technology advances on the distribution level, the electricity production of wind and solar power it can be better adjusted for the needs of the grid by the help of the battery technology.

## 8.2 Exclusivity Effect of Using Smart Grid Technologies

The security of remote reading technology has raised conversation worldwide according to chapter 4 (Savolainen, P et al). There are some issues regarding Smart Grid technologies such as the security of Smart Grid implementations. For example, remote reading for energy usage is widely used for reading customers' energy consumption and can use internet connection for that purpose. There is not a common standard for the area nor comprehensive security instructions.

There are really security holes when it comes to the remote reading but the benefits of exploitation are minimal. The remote reading system can use internet or public radio network to deliver information to the reading and operating systems. This can bring opportunities for mischief. If the operating system is implemented as an independent network and security has taken into account, it can lower the risks of misuse and access of unauthorized parties.

There are also the threat that the AMM systems would allow remote mass control. It holds great risks and a possibility of serious damage that can be materialized by incorrect remote connection. Human error, negligence, lack of education or lack of code of conduct and system errors or faulty components should be taken into account. The standards of Smart Grid security are still inadequate in national level. There are some standards to follow up in AMI security implementations according to Savolainen, P et al. (8).

As Bush states in his publication (Bush 2014, 199) the technology improves in such a fast phase it can create problems in compatibility of the components. Even today, there are cases where energy providers might struggle with the compatibility of smart meters and other components. Only a fraction of possible technologies is in commercial use today. It is impossible to predict the future development.

## 8.3 Usage Effect of the Smart Grid Technology on Customer Level

To develop Smart Grid solutions the consumer has risen to the center in the field of electricity distribution and electricity sales businesses in the last years. The

fields that have been comprehended as quite conservative have been focusing more and more on the quality and development of customer service.

Smart metering and smart meters are probably the most visible parts of the Smart Grid technology seen from the customer's point of view as stated in chapter 3.2. The installation of smart meters in the customers' end it creates many opportunities for electricity distribution solutions. Smart meters are essential in bidirectional communication in the distribution network. It is also possible to adjust electricity consumption in a more intelligent way in homes equipped with smart meters. They allow to adjust electricity usage in times when the price of electricity and demand is low. For example the meters can be adjusted to track down the price of electricity and when a certain threshold is reached to heat a boiler or charge an EV is possible.

Smart Grid enables the connection of renewable energy sources into the electricity network and consumers are able to have micro production. It is also possible to make use of distributed energy by exploiting renewable energy sources as stated in chapter 5 (Bush 2014, 261). This way a customer who has only consumed electricity can now also produce and sell electricity and act as an electricity producer due to the possibilities of micro production. Other possibilities for customer to actively act in the field of electricity market is a choice of product and tariffs, load control, flexibility in electric consuming, and micro production. These options require high-quality information exchange where smart meters holds a key role. In Finland Fingrid is developing a data hub, which gives customers an access to check one's basic information and use it to, for example invite tenders for electricity contracts.

There are still some concern regarding the security of smart meters. In the future the electricity grid is increasingly linked to the internet. This can bring different kinds of security issues and a risk of hacking. This can lead to the abuse of the customer's personal information or even the electricity grid.

#### 8.4 Load Control Possibilities in Smart Grids

The measurement data and load control possibilities provided by the AMM systems make it is possible to gain better control of low-voltage grid but also medium-

voltage grid load and fault conditions according to Savolainen, P et al. (23) so in this way AMI creates a lot of possibilities for load control in Smart Grid solutions. This covers the management, the information and communication systems, the energy efficiency, the protection and the power quality. The AMI solutions should be managed well in order to be aware of the changes at each point in the distribution network. This area covers meters, communication network and network management system so smart metering becomes an important factor.

The load control means that end-use loads can be changed in response to particular events for example when the price of electricity is high or there are problems in the electricity network. Smart meters are in focus in load control. The meters enable the customer to track down the electricity consumption in real time and can be used to control heating for example. In addition the loads can be controlled based on electricity pricing. This way when the price is high the smart meter can disconnect the load from the network or lower the use of power. Loads such as the heating of an apartment also can be managed by based on timing. This way the consumer is able to help in maintaining the stability of the electricity grid.

When load control options increase, a need for different energy storage solutions increases as well. For example households could be able to use energy during the peak loads by using the EV battery storage technology. By exploiting load control solutions the charging time could be set so there would not be any consumption peak.

## 8.5 Smart Grid Solutions for Two Way Power Transfer

As IEC (2010, 13) states, communication between energy consumption and the energy provider plays an important role in Smart Grid solutions. So the two-way power transfer is in a key role as well. Enabling two-way power transfer the electricity network must be intelligent enough to know the amount of electricity consumption on every usage point even on level of minutes. If the consumer is able to produce electricity more than he/she needs the electricity can be sold to an electricity company. The distribution network must be intelligent enough to communicate between the consumer and the electricity provider.

Smart meters are gaining popularity and are the main solution to enabling the two-way power transfer. New smart meters have more memory capacity and can save a lot of different information about the actions of the electricity network. The old meters have only measured electricity consumption on that specific usage point. The electricity provider is able to have the information of electricity network's actions and consumption information on every usage point from the smart meters. This way the energy flow can be better directed in a more sufficient way. As Caruna (2016) states, the electricity consumers can also benefit from the usage of smart meters. The consumer is able to track down his/her electricity consumption and adjust the energy usage in a more profitable way.

#### 8.6 Smart Grid Solutions for Energy Production Control

The studies of the LVDC distribution solutions by University of Vaasa reveals that micro grids are a great solution to promote a better quality of electricity and they can add reliability and flexibility for electricity distribution. Micro grids can operate partly or fully as an independent distribution network in which case it is an island operation. When some part of micro grid is loose from the national power grid the micro grid is able to produce energy and provide unbroken electricity production even if the fault would occur in the general grid as Bush states (2014, 261).

What Bush also states is that DG faces challenges in managing the quality and quantity of energy (2014, 268). It also applies to island operation and in this case energy storages plays an important role when it comes to even the load peaks. Energy storages are also able to compensate the oscillation of voltage and frequency. In little island operations even little changes in production and consumption can make a noticeable effect on the national grid level.

#### 8.7 Smart Grid Solutions and Usage for Safety Margins and Reserve Margins

In Smart Grid solutions energy storages are needed for reducing the risk of electricity network overload. When the consuming peak occurs, energy storages can be used to input additional capacity. This way it is not always necessary to use emergency power plants to even the peak loads as the electricity consumption is greater than the production.

As Bush states (2014, 259) that when little additional electricity production units are located on different sides of the electricity network, production capacity can be increased. In the distributed structure the same network is able to fulfill the loads of several consumers. This feature can be seen the most at the peak times of consumption. On the other hand when the production is located near the consumption point the transmission length and power loss are small.

Smart Grids hold relatively new technology and there are not much information about the benefits that Smart Grid solutions could offer. There are many pilot projects regarding the Smart Grid but there are not much practical achievements yet. There are restrictive factors such as high price that has been one of the obstacle to move towards Smart Grid solutions. But as the traditional power grid will face challenges moving towards the Smart Grid solutions will be likely in the future.

## 9 CONCLUSION

The main study areas of the thesis was to sort out the latest technology and studies of Smart Grids and possible technologies entering into the markets. The results summarizes and suits the found technologies for the research problems. The results are based on the references found during the research. The evaluation of the references was important during the research. The references consist of some of the most important actors on the field of energy and specialist publications. There are also some references written by common journalists. Most of the publications are public which should be able to be found by anyone holding an interest towards the subject.

In general, the thesis tries to summarize the technology, which is involved in Smart Grid solutions. The thesis mainly focuses on the distribution level but also covers some technology involved in the whole electricity grid such as the network automation, battery technology, and electric vehicles. The concept of the Smart Grid is still quite a new subject and does not really hold many comprehensive publications or evidence even though they are increasing in numbers. The concept of the Smart Grid can also be quite an extensive so one of the challenges was to crop the subject to be reasonable and so the thesis serves the purposes of the research.



## REFERENCES

- ABB. N.D. TTT-käsikirja 2000-07. Referred to 14.11.2016  
[http://www.oamk.fi/~kurki/automaatiolabrat/TTT/15\\_S%84hk%94njakeluverkon%20automaatio.pdf](http://www.oamk.fi/~kurki/automaatiolabrat/TTT/15_S%84hk%94njakeluverkon%20automaatio.pdf)
- Aidon Oy. 2010. Oulun Seudun Sähkö uusii etäluentajärjestelmänsä. Referred to 28.12.2016 <http://www.aidon.com/fi/oulun-seudun-sjarjestelmansa/>
- Aidon Oy. 2016. Referred to 15.12.2016 <http://www.aidon.com/fi/ratkaisumme/>
- ARES. 2016. Referred to 15.12.2016 <http://www.aresnorthamerica.com/>
- Bayindir, R., Colak, I., Fulli, G., Demirtas, K. 8/2016. Renewable and Sustainable Energy Reviews, Smart grid technologies and applications. VIT University. Referred to 19.10.2016 <http://ez.lapinamk.fi:2448/10.1016/j.rser.2016.08.002>
- Bush, Stephen F. 2014. Wiley - IEEE: Smart Grid: Communication-Enabled Intelligence for the Electric Power Grid (1) referred to 15.12.2016  
<http://ez.lapinamk.fi:2054/lib/ramklibrary/reader.action?docID=10827036>
- Caruna. 2016. Sähkömittari. Referred to 13.10.2016 <https://www.caruna.fi/sahkomittari>
- Carvalho, A., Cooper, J. 6/2011. Artech House: Advanced Smart Grid. ISBN 9781608071289. Referred to 8.12.2016 <http://ez.lapinamk.fi:2054/lib/ramklibrary/reader.action?docID=10500329>
- EDSO. 2016. Why smart grids? Referred to 13.10.2016 <http://www.edsoforsmartgrids.eu/home/why-smart-grids/>
- Elovaara, J., Haarla, L. 2011a. Sähköverkot I. Järjestelmätekniikka ja sähköverkon laskenta. Helsinki: Otatieto
- Elovaara, J., Haarla, L. 2011b. Sähköverkot II. Verkon suunnittelu, järjestelmät ja laitteet. Helsinki: Otatieto
- Energiateollisuus ry. 2016. Kohti älykästä energiajärjestelmää. Referred to 12.12.2016  
[http://energia.fi/energiateollisuuden\\_edunvalvonta/energiapolitiikka/energiaverkot](http://energia.fi/energiateollisuuden_edunvalvonta/energiapolitiikka/energiaverkot)
- Energy Vaasa. 2016. Smart grid pilot project in Vaasa. Referred to 26.10.2016  
<http://energyvaasa.vaasanseutu.fi/smart-grid/>
- ENSTO. 3/2016. Tasasähkö palaa julkiseen sähkönjakeluun. Referred to 13.12.2016 <http://www.ensto.com/fi/yhtio/uutiset-ja-media/konserniutiset/tasasahko-palaa-julkiseen-sahkonjakeluun/>

ESA. 2016. Energy Storage. Referred to 13.12.2016 <http://energystorage.org/energy-storage>

Fingrid Oyj. 2016. Power System in Finland. Referred to 16.11.2016 <http://www.fingrid.fi/en/powersystem/general%20description/Power%20System%20in%20Finland/Pages/default.aspx>

Fingrid Oyj. 3/2012. Corporate magazine 15th volume. <http://www.fingrid.fi/en/news/publications/magazine/Pages/default.aspx>

Finnwind Oy. 2013. Aurinko-opas. Referred to 14.12.2016 <http://www.finnwind.fi/aurinko/Aurinkoenergiaopas-Finnwind.pdf>

Huttunen, R. 4/2014. Älyn käyttö suotavaa. Energiavirasto. Referred to 13.10.2016 <http://www.energiavirasto.fi/reilua-energiaa/>

IEA. 4/2011. Technology Roadmap Smart Grids. Referred to 28.12.2016 [https://www.iea.org/publications/freepublications/publication/smart-grids\\_roadmap.pdf](https://www.iea.org/publications/freepublications/publication/smart-grids_roadmap.pdf)

IEC. 2010. Smart Grid Standardization Roadmap. Referred to 13.12.2016 [http://www.iec.ch/smartgrid/downloads/sg3\\_roadmap.pdf](http://www.iec.ch/smartgrid/downloads/sg3_roadmap.pdf)

IEC. 2011. Electrical Energy Storage. Referred to 11.11.2016 <http://www.iec.ch/whitepaper/pdf/iecWP-energystorage-LR-en.pdf>

Jülch, V. 8/2016. Comparison of electricity storage options using levelized cost of storage (LCOS) method. Institute for Solar Energy Systems ISE, Germany. Referred to 15.12.2016

Jönköping Energi. 2016. Referred to 10.5.2017 <https://www.jonkopingenergi.se/elnat/din-elanlaggning/din-elmatare/aidon-5530>

Kamstrup 2016. Tietoturva. Referred to 25.11.2016 <https://www.kamstrup.com/fi-fi/business-areas/electricity-metering/data-security>

Lameck, Gasto, A. Thesis. INTEGRATING ELECTRIC VEHICLES INTO SMART GRID USING IEC 61850 AND ISO/IEC 15118 STANDARDS. University of Vaasa. Referred to 17.11.2016 <https://www.tritonia.fi/fi/e-opin-naytteet/tiivistelma/6813/INTEGRATING+ELECTRIC+VEHICLES+INTO+SMART+GRID+USING+IEC+61850+AND+ISO%7CIEC+15118+STANDARDS+>

Landis+Gyr. 2016. Referred to 12.10.2016 <http://www.landisgyr.fi/about/landisgyr/>

MOTIVA. 9/2016. Pienvesivoima. Referred to 23.11.2016 [http://www.motiva.fi/toimialueet/uusiutuva\\_energia/vesivoima/pienvesivoima](http://www.motiva.fi/toimialueet/uusiutuva_energia/vesivoima/pienvesivoima)

MOTIVA. 10/2016. Täyssähköauto Referred to 14.12.2016 [http://www.motiva.fi/liikenne/henkiloautoilu/valitse\\_auto\\_viisaasti/autotyypit/tayssahkoauto](http://www.motiva.fi/liikenne/henkiloautoilu/valitse_auto_viisaasti/autotyypit/tayssahkoauto)

Mäkinen, J. 10/2016. Sähköautojen matkat pitenevät, mikä muuttuu latauksessa? ABB. Referred to 8.11.2016 <http://www.abb-conversations.com/fi/2016/10/sahkoautojen-matkat-pitenevat-mika-muuttuu-latauksessa/>

Oulun Seudun Sähkö Oy. 2016a. Asiakkaan oma sähköntuotanto. Referred to 14.12.2016 <https://www.oulunseudunsahko.fi/Sahko/Sahkonsiirto/Asiakkaan-oma-sahkontuotanto>

Oulun Seudun Sähkö Oy. 2016b. Etäluettavat sähkömittarit. Referred to 14.12.2016 <https://www.oulunseudunsahko.fi/Sahko/Sahkonsiirto/Asiakkaan-oma-sahkontuotanto>

Partanen, J., Pyrhönen, J., Silventoinen, P., Niemelä, M., Lassila, J., Kaipia, T., Salonen, P., Peltoniemi, P., Nuutinen, P., Lana, A., Haakana, J., Pinomaa, A., Makkonen, H., Voutilainen, V., Paajanen, P., Järventausta, P., Tuusa, H., Suntio, T., Kannus, K., Lahti, K., Nikander, A., Mäkinen, A., Alahuhtala, J., Sunttila, T., Nousiainen, L., Rekola & J., Vornanen, T. 2010. Tehoelektroniikka sähkönjake-lussa – Pienjännitteinen tasasähkönjakelu. LUT. Referred to 25.10.2015.  
<http://www.lut.fi/documents/10633/138922/Tehoelektroniikka+sahkonjake-lussa+Loppuraportti+2010/639848d0-86c0-47ff-a9fc-057f745ff360>

Perttu, J. 10/6. Maailmalla pohditaan, kuinka sähköä kannattaa varastoida – startup-yhtiön ratkaisu on kivillä lastattu juna. Helsingin Sanomat. Referred to 10.11.2016 <http://www.hs.fi/tiede/a1465536206367>

Petäjäjärvi, A. 2015. Saarekekonvertterin käyttö mikrotuotannossa. Lapin AMK. Referred to 23.11.2016 [http://www.theseus.fi/bitstream/handle/10024/103268/Petajarvi\\_Aila.pdf?sequence=1](http://www.theseus.fi/bitstream/handle/10024/103268/Petajarvi_Aila.pdf?sequence=1)

Pietarinen, H. 10/2014. Joka kotiin saatiin juuri älysähkömittari – kohta ne uusitaan taas. Iltasanomat. Referred to 13.10.2016 <http://www.iltasanomat.fi/taloussanomat/art-2000001855230.html#commentsHere>

Rytkönen, T. 8/2016. Energiasta, älystä ja turvasta. Energiateollisuus. Referred to 24.11.2016 [http://energia.fi/ajankohtaista\\_ja\\_materiaalipankki/blogi/energiasta\\_alysta\\_ja\\_turvasta.491.blog](http://energia.fi/ajankohtaista_ja_materiaalipankki/blogi/energiasta_alysta_ja_turvasta.491.blog)

Savolainen, P., Koponen, P., Noponen, S., Sarsama, J., Toivonen, J. 12/2013. AMM Tietoturva, VTT. Referred to 16.11.2016 [http://energia.fi/ajankohtaista\\_ja\\_materiaalipankki/materiaalipankki/amm\\_tietoturvaselvitys\\_-\\_sahkotutkimuspoolin\\_julkaisu.html](http://energia.fi/ajankohtaista_ja_materiaalipankki/materiaalipankki/amm_tietoturvaselvitys_-_sahkotutkimuspoolin_julkaisu.html)

Sujitha N., Krithiga S. 11/2016. RES based EV battery charging system: A review. VIT University. Referred to 17.11.2016  
<http://ez.lapinamk.fi:2448/10.1016/j.rser.2016.11.078>

Turun Energia. 2016. Sähkön mittaus. Referred to 13.10.2016  
<http://www.turkuenergia.fi/sahkoverkko/sahkoliittyma-ja-sahkon-mittaus/sahkon-mittaus/>

Työ- ja elinkeinoministeriö (TEM). 2016. Referred to 16.12.2016  
<http://tem.fi/perustietoja>

Vattenfall 3/2014. Vesivoima – toimintaperiaate. Referred to 15.12.2016  
<https://corporate.vattenfall.fi/tietoa-energiasta/sahkon-jalammontuotanto/tietoa-vesivoimasta/vesivoima-toimintaperiaate/>

VTT. 5/2014. Sähköbussi latautuu pian myös pysäkillä. Referred to 17.11.2016  
<http://www.vtt.fi/medialle/uutiset/s%C3%A4hk%C3%B6bussi-latautuu-pian-my%C3%B6s-pys%C3%A4kill%C3%A4>