

KYMENLAAKSON AMMATTIKORKEAKOULU
Muotoilun koulutusohjelma/ Tuotemuotoilu

Janika Määttä

MOBIILITYÖSKENTELYYN SOPIVIA KALUSTE- JA VARUSTEKONSEPTEJA
JULKISEEN TILAAN

Opinnäytetyön liitteet

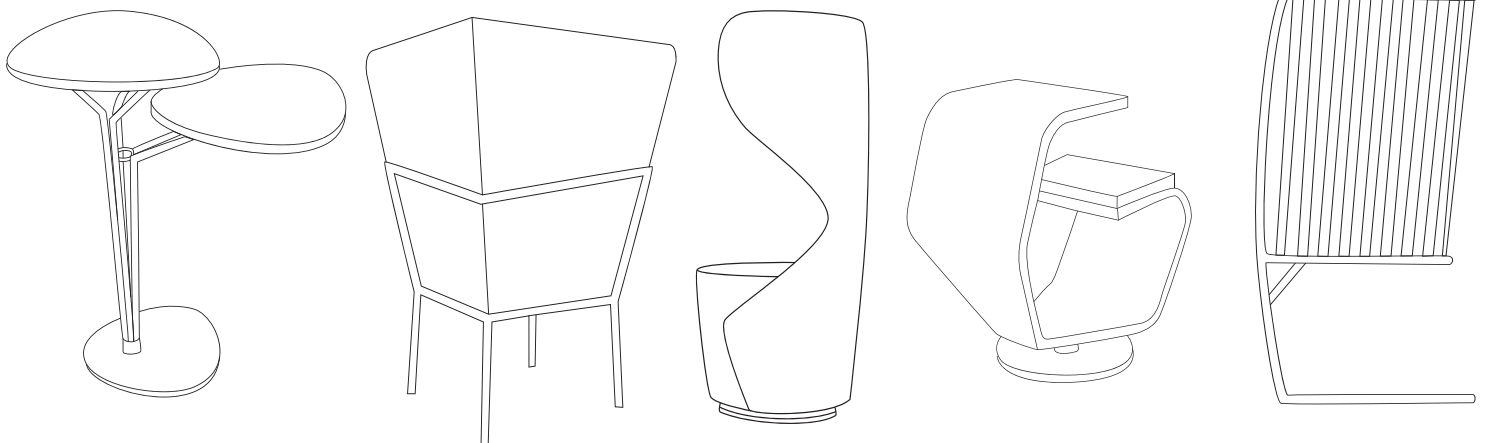

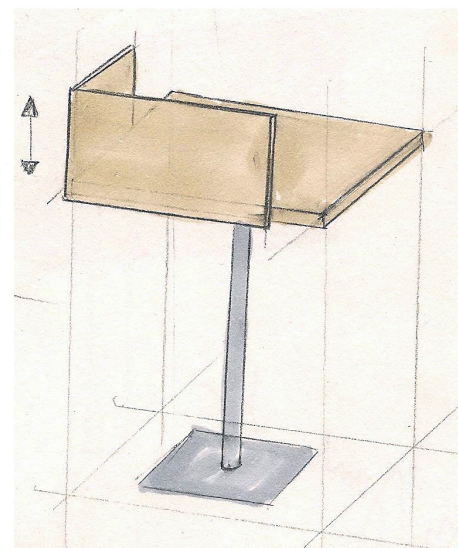
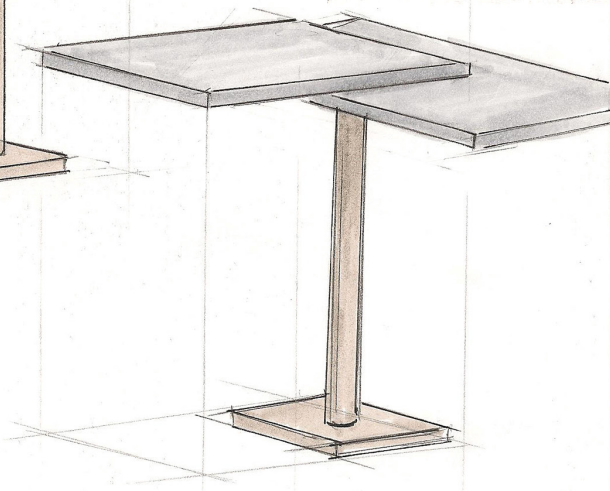
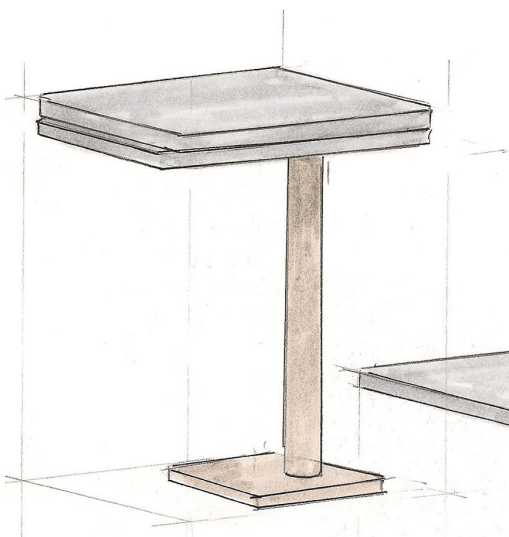
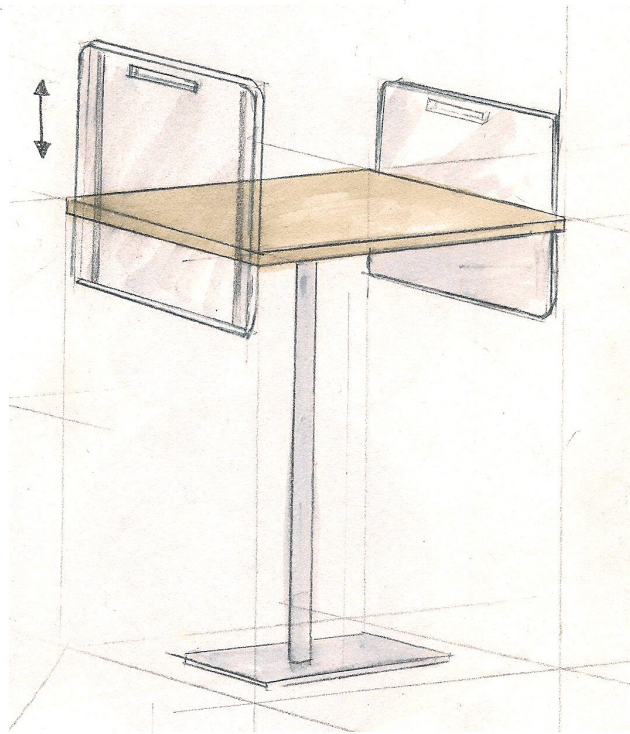
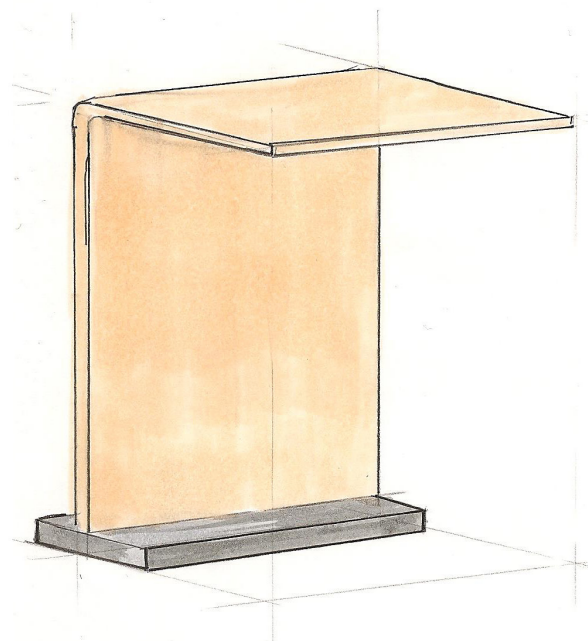
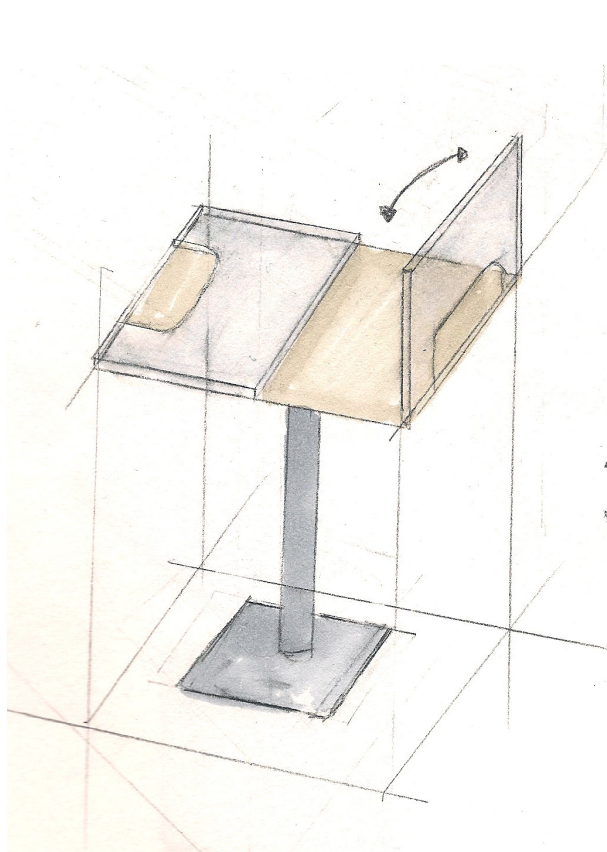

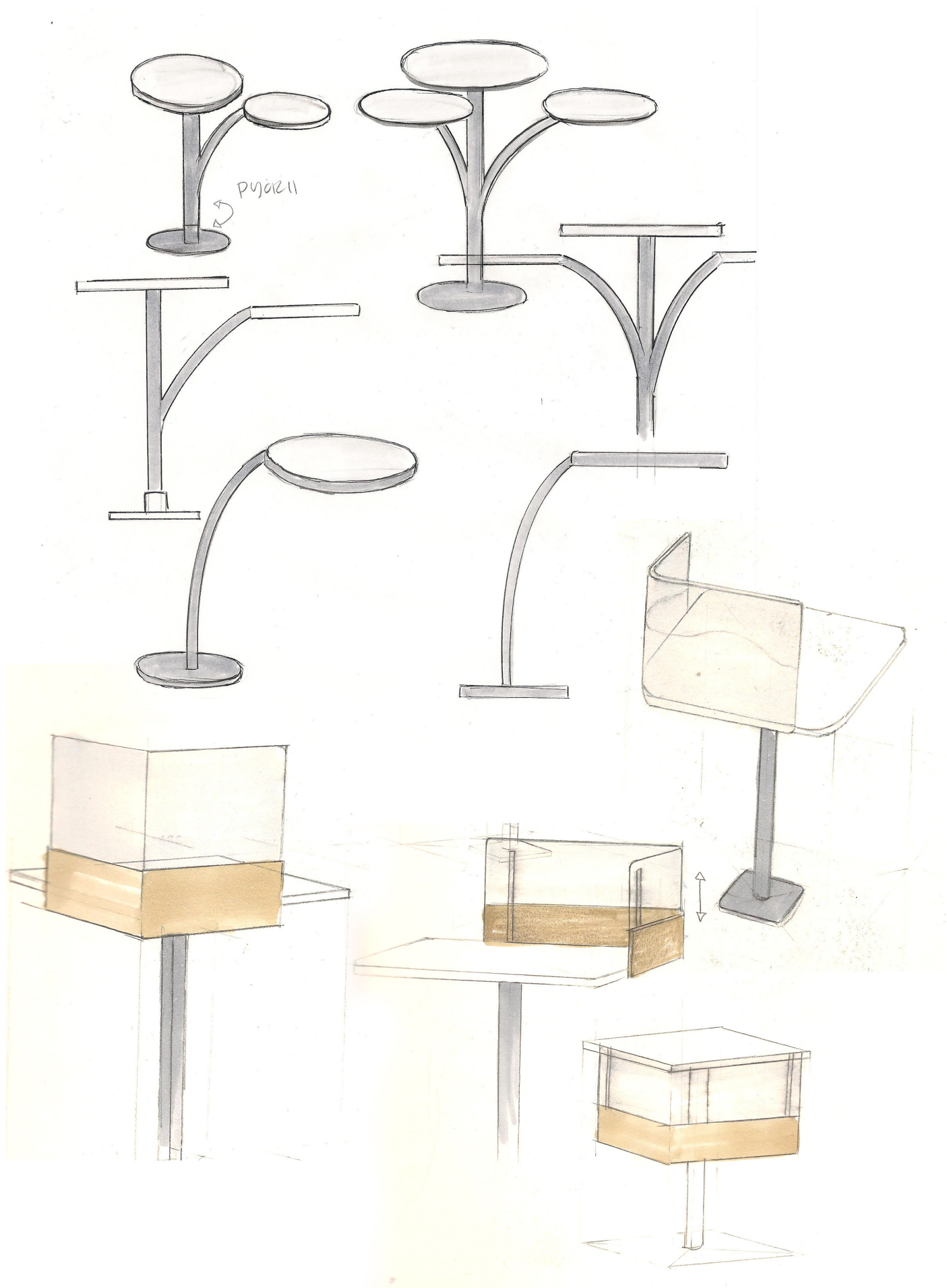



ISTUMINEN KAHDESTA SUUNNASTA

PÖYTÄ REUNEMMAKSI

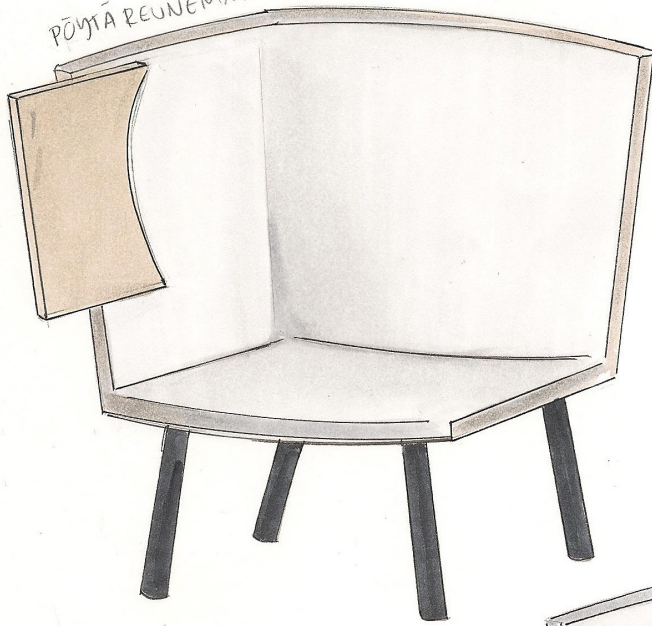

NOJATUOLIN
TILANUJALAN
PÖYTÄ / KASINOJA



15 ENEMMÄN PEHMUSTETTIA?
JALAT?



KORKEAMPI SELKÄNOJA

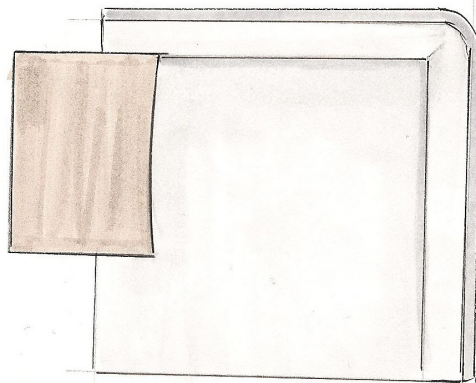

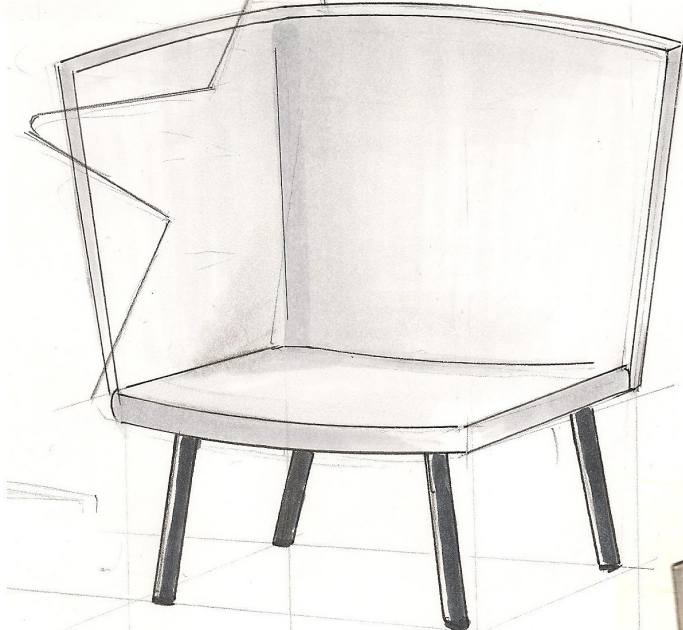
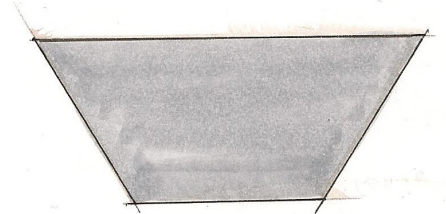
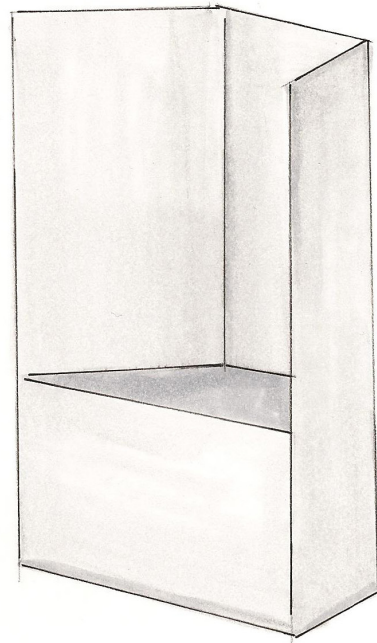
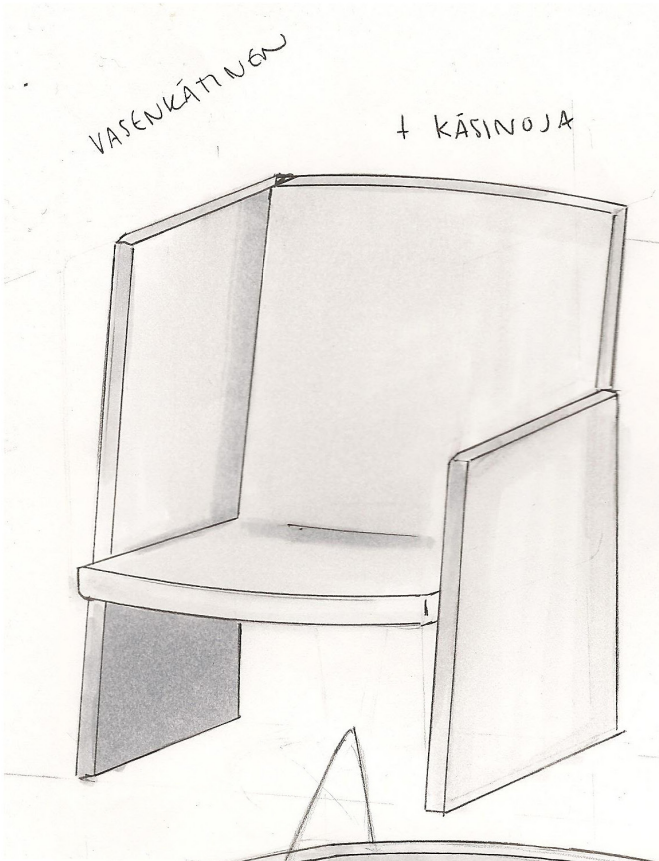

- joutavia päällystettyjä
jousia

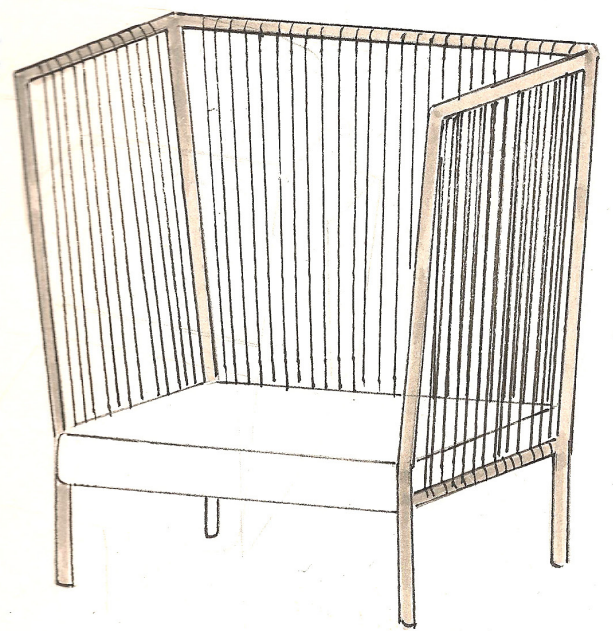
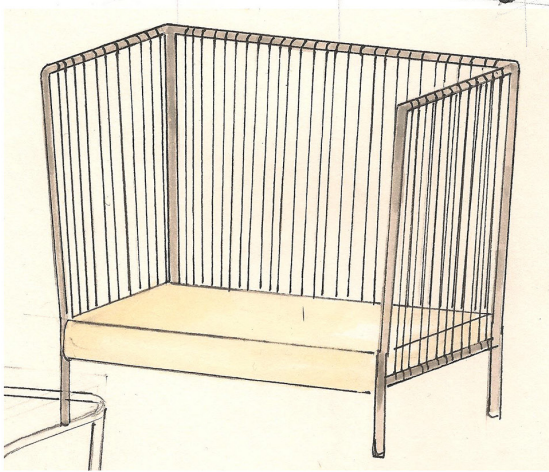

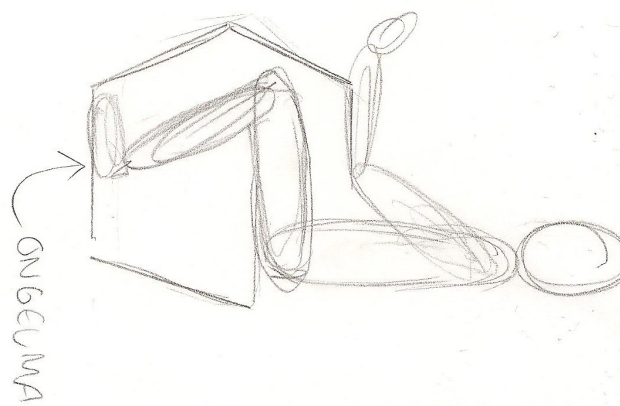
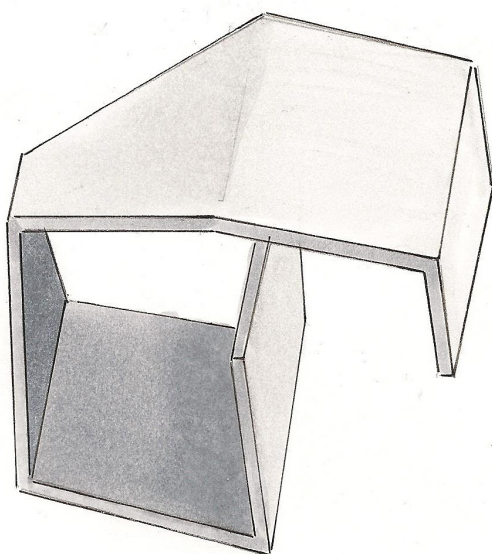
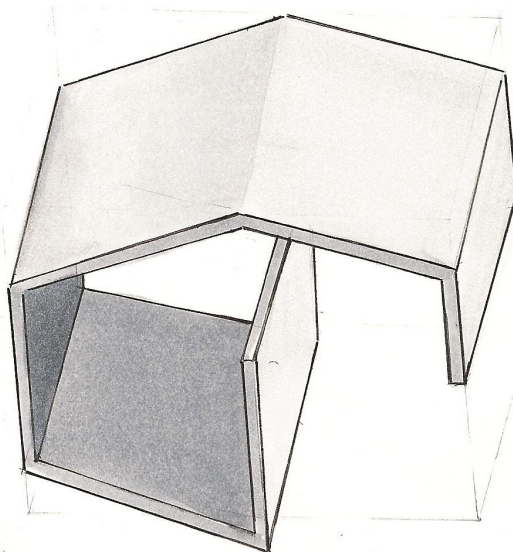
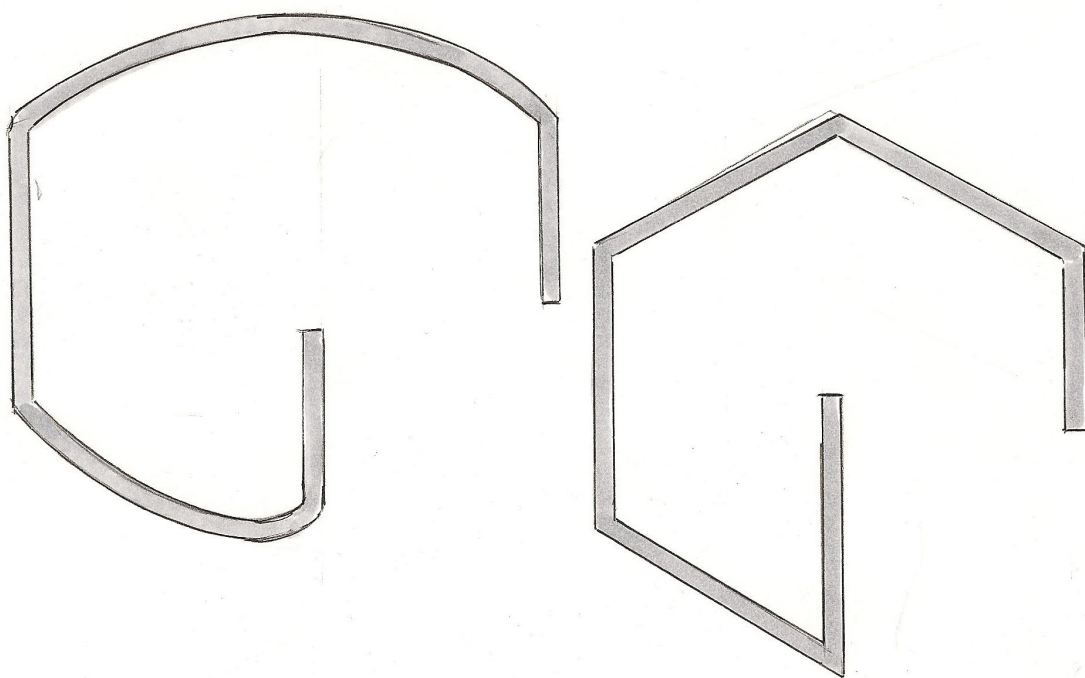

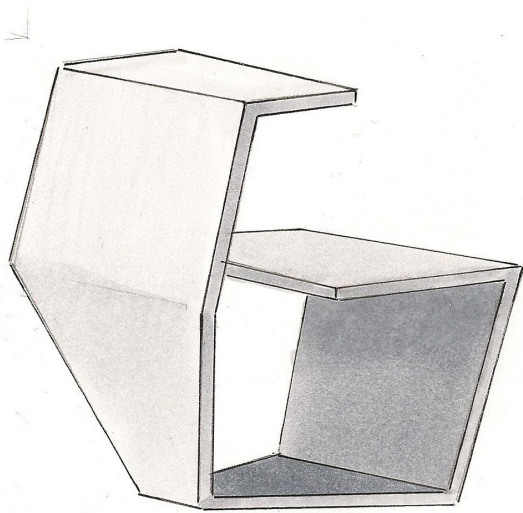

KOLKEAMPI SELKÄNOJA

