

Building construction

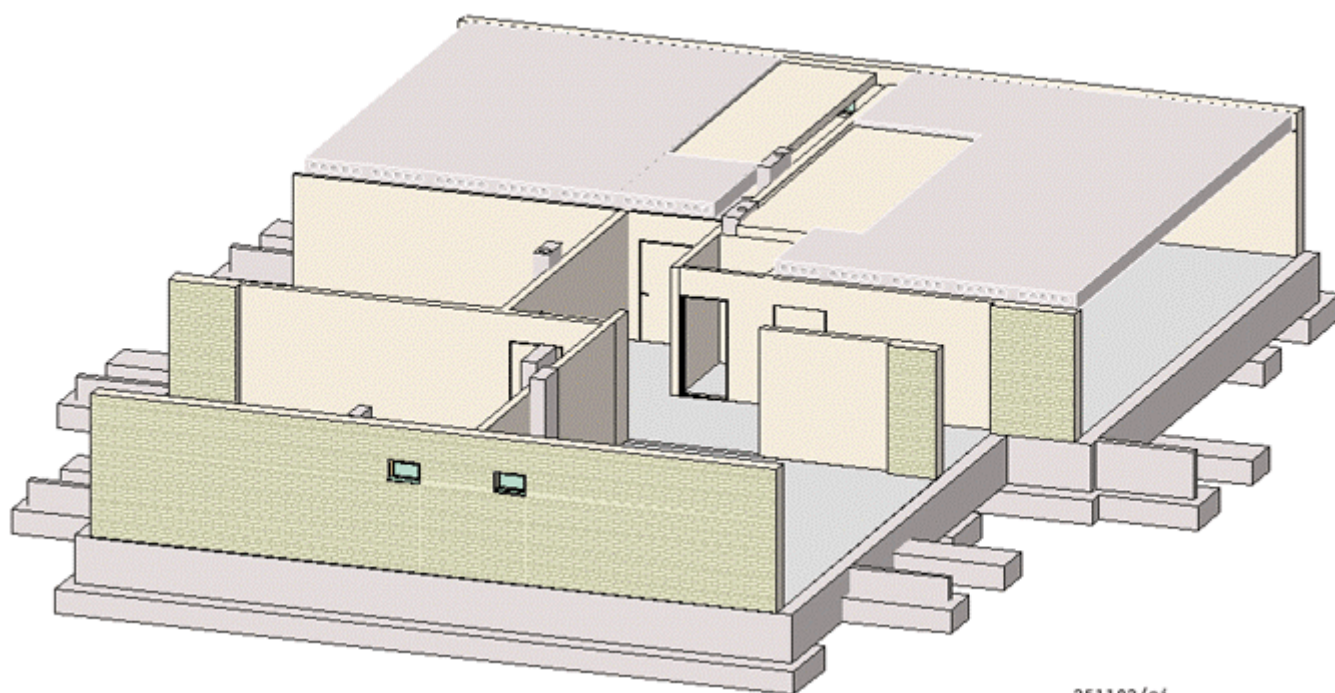

251102/oi

Olli Ilveskoski

Building Construction

Olli Ilveskoski

Building Construction
Olli Ilveskoski

e-publication

ISBN 978-951-784-686-8 (PDF)

ISSN 1795-424X

HAMKin e-julkaisuja 29/2014

© HAMK University of Applied Sciences and the authors

PUBLISHER

HAMK University of Applied Sciences

PO BOX 230

FI-13101 Hämeenlinna, FINLAND

tel. (03) 6461

julkaisut@hamk.fi

www.hamk.fi/julkaisut

Layout: HAMK Publications

Hämeenlinna, November 2014

Contents

Introduction	6
1 Introduction to the Building Construction	7
1.1 The Single Occupancy House	7
1.1.1 The Architectural Design	8
1.2 The Single Occupancy Structural Design	16
1.3 Building Information Modelling of a Single Occupancy	21
1.3.1 Building Information General	22
1.4 CASE: ArchiCad- modelling	22
1.4.1 BIM Building Information Modell and the drawings	30
2 The Building Process Guidelines	46
2.1 Guidelines	46
2.1.1 The Land Use and Building Act	46
2.1.2 Forms of the Building Permit	47
2.1.3 Content of YSE 1998 General Agreement Conditions	47
2.1.4 Master Format	49
2.2 Construction Management.....	50
2.2.1 Project stages	51
2.2.2 Organizing for Project Management.....	54
2.2.3 Cost Estimation	59
2.2.4 Fundamental Scheduling Procedures	61
2.2.5 Cost Control, Monitoring and Accounting.....	61
2.2.6 Quality Control and Safety During Construction	61
3 The National Building Code of Finland	62
3.1 Introduction	62
3.1.1 A General section	62
3.1.2 B The strength of structures	62
3.1.3 D Hepac and energy management	63
3.1.4 E Structural fire safety.....	63
3.1.5 F General building planning.....	64
3.1.6 G Housing planning and building	64
3.2 Loads	66
3.3 Sound insulation	78
3.4 Moisture	106
3.5 Fire safety of buildings	115
3.6 Housing Design	116
4 Framing	117
4.1 Concrete Block Framing.....	117
5 Concrete Unit Framing.....	122
5.1 Residential buildings	122
5.2 Building Components	127

6 Concrete Construction	135
7 Multi-Storey Residential Houses	147
7.1 Building Designs	148
7.2 Structural Design	148
7.3 Virtual Concrete Unit Multi-Storey BES- House	149
7.4 Virtual In Situ Multi – Storey Building	161
8 Steel Construction	171
9 Timber Construction	179
9.1 Gluelam Structures	180
9.2 The Timber- Frame Multi-Storey Residential Houses	186
9.3 Big Timber Structures	190
10 Masonry Houses	192
10.1 Masonry.....	192
10.2 In Situ Frames	192
11 Combination Structures	196
12 References	199
13 Annexes	200

Introduction

I was during the years 2000 – 2006 a coordinator of the Virtual Polytechnic. The purpose was to develop Virtual Material about Building Projects, which can be utilized in different Courses: e.g. Mechanics, Single Occupancy, Building Construction, Structural Engineering, Building Information Modeling and Electric Design. The participants were

Turku Polytechnic /Mechanics	Senior Lecturer	Tero Öberg
Turku Polytechnic /Timber Structures	Senior Lecturer	Raimo Vierimaa
Vaasan Amk / Rakennuttaminen	Senior Lecturer	Marja Naaranoja
Seinäjoen Amk / Tietomallinnus	Lecturer	Päivi Jalava
Tampereen Amk / Teräsrakentaminen	Lecturer	Risto Lilja
Tampereen Amk / Sähköpätevyys	Senior Lecturer	Pirkko Harsia
Hämeen Amk / Talonrakennus	Senior Lecturer	Olli Ilveskoski

In addition the Finnish Concrete Industry Association, the Wood Focus, The Finnish Steel Construction Association and Suorakanava Media took part in the project.

This publication is a summary of the Building Construction manuscript and the virtual material in the address www.amk.fi. The objective is that the student gets involved with the construction of Single-Family House, Multi-Storey Residential House and Commercial-Office houses. As the student works with the project he/she learns topics like Information Sources, Law, Act, Codes, Framing, Loads, Thermal Insulation, Moisture, Soundproofing and Fire Engineering. The Materials and Products are studied as well.

I thank the Participants for their contributions. The still under development material has been in use in Building Construction courses in HAMK University of Applied Sciences and is being finished according to the manuscript in the future.

Olli Ilveskoski
Senior Lecturer

10.10.2014 Hämeenlinna

1 Introduction to the Building Construction

/1/ www.amk.fi

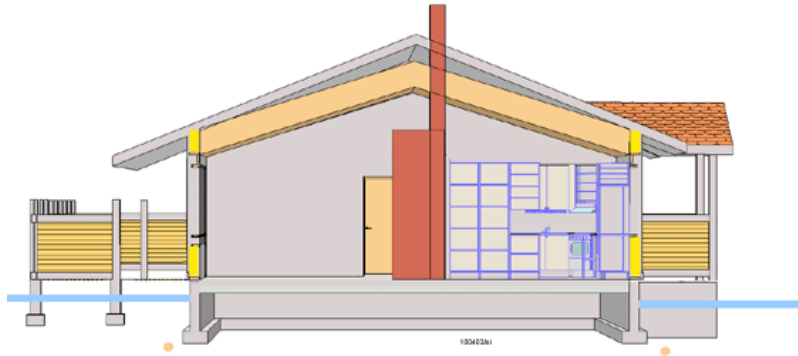

FIG 1 The timber-frame single occupancy

1.1 The Single Occupancy House

General

Small houses are generally 1 – 2 storey single-family houses. The building frame may be made for example of wood, brick, concrete or steel. The study book presents different building methods. The timber frame example house's architectural and structural designs are made. The student participates in the one-family house design and construction.

1.1.01 The Building Project

1.1.02 The Single Occupancy Project

General

The construction project is usually divided into the design, construction and property maintenance phases. At each stage the aim is to provide guiding documents. The design phase is divided into the preliminary evaluating and the building design. The building process includes the tender for the construction works, the contracts and the quality survey. Work performance is being received and the building is maintained according to the instructions. Construction, Production Planning and Site Engineering courses present how the participants and specialists are involved in the project.

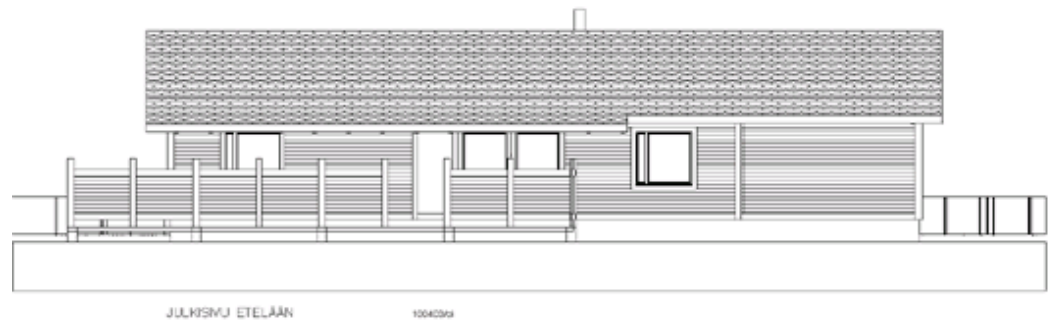

FIG 2 Single Occupancy Permit Drawing

1.1.1 The Architectural Design

Small house architectural design focuses on the concepts of building construction, building components, the Building Law, Building Codes, construction phases, permit drawings as well as design criterias.

- 11.30 Building components
- 11.31 Building Law and Act
- 11.32 Building Code
- 11.33 Urban Planning
- 11.34 Project Management
- 11.35 Design criterias
- 11.36 Permit Drawings
- 11.37 Implementation Drawings
- 11.38 Master Documents

Small Occupancy Houses can be framed with different solutions:

- Timber Frame House
- Concrete or Brick Block Frame House
- Siporex-Light Concrete Frame House
- Concrete Unit Single Occupancy

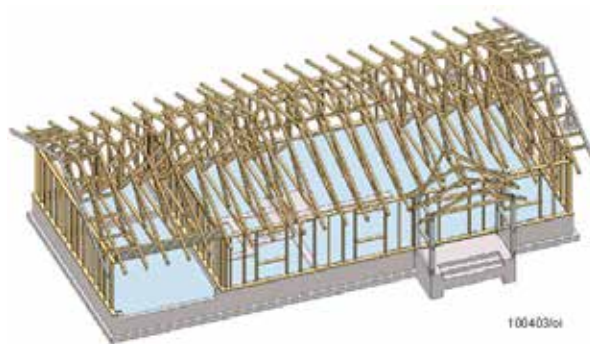

FIG 3 Axonometry

Building Components

Building Components are e.g. floor, wall, ceiling, foundation, frame, balcony, stairs, roof, windows, doors and furniture. Single-family house building components must comply with eg thermal insulation, moisture, sound and fire requirements

Foundation

The basement is designed under the bearing frame of the residential floor. The loads are carried by the bearing structures to the foundation and again to the soil. The foundation type can be e.g. strip foundation or pile foundation depending the properties on the ground.

Frame

The frame components are e.g. walls, columns, beams, slabs, stairs and balconies. The small occupancy frame can be made of timber, brick, concrete or steel. The frame must be able to carry the loads and transfer them to the soil. The frame must must comply with eg thermal insulation, moisture, sound and fire requirements. The alternative frame solutions of a single occupancy are e.g. bearing external wall or bearing partition wall solutions.

Roof

The roof is expected to comply the durability, appearance and economical requirements. The roof shape can be either pitched, hipped, slope or flat roof. The bearing structure can be either a timber truss, LVL, gluelam or sawn timber. The roofing can be e.g. bitumen carpet, roof brick or metal sheetings.

Windows and doors

The window and door frames can be e.g. timber, aluminium or plastic and they have thermal and sound insulation requirements.

Furniture

The fixed furniture includes e.g. cabinets, countertops, shelves, cupboards, wardrobes and space group e.g. sauna furnishing. The furniture comply often the 3M- module system.

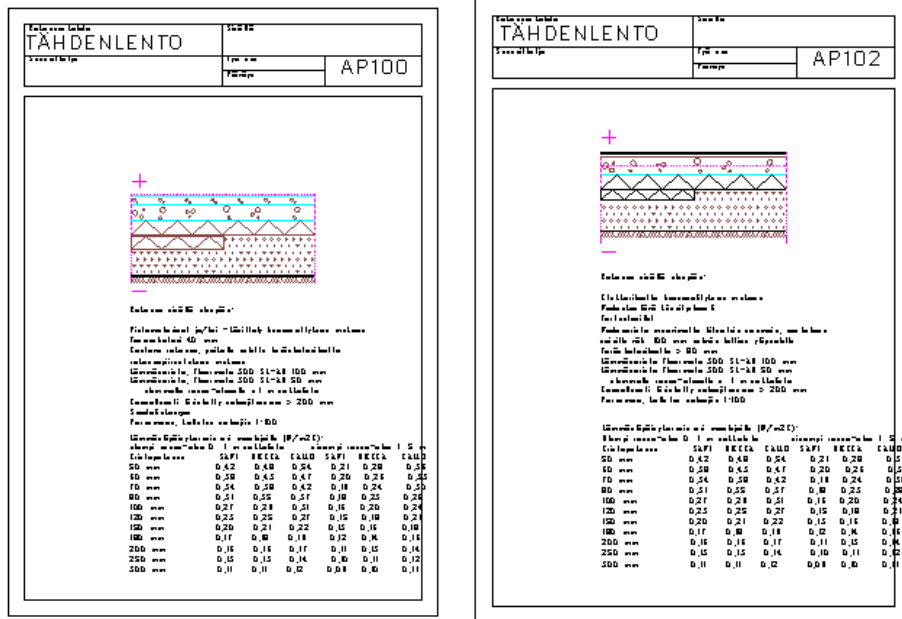

FIG 4 Building Components: Floor structures

Building Components

The permit drawings include the A4- Building Components in scale 1:10. The plan and section drawings have references to the building component documents.

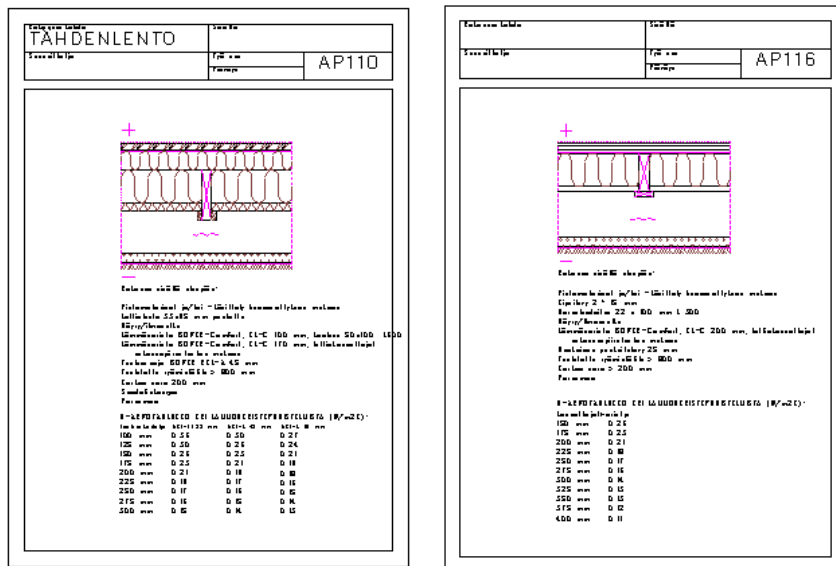

FIG 5 Floor Structures

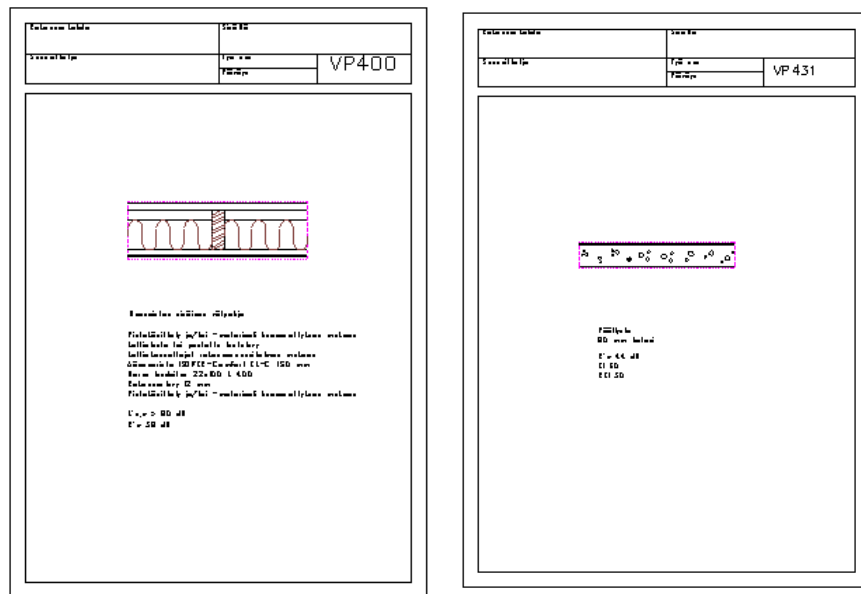

FIG 6 Intermediate Floor Structures

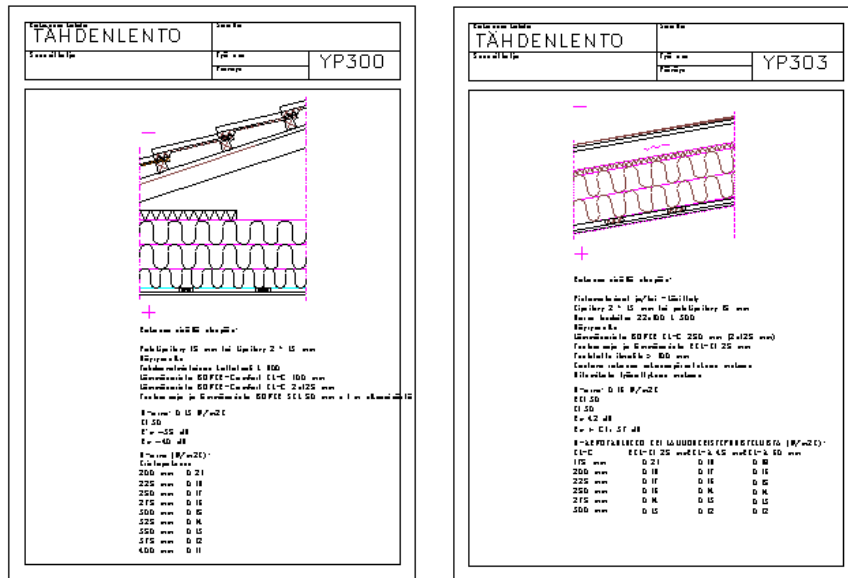

FIG 7 Roof Structures

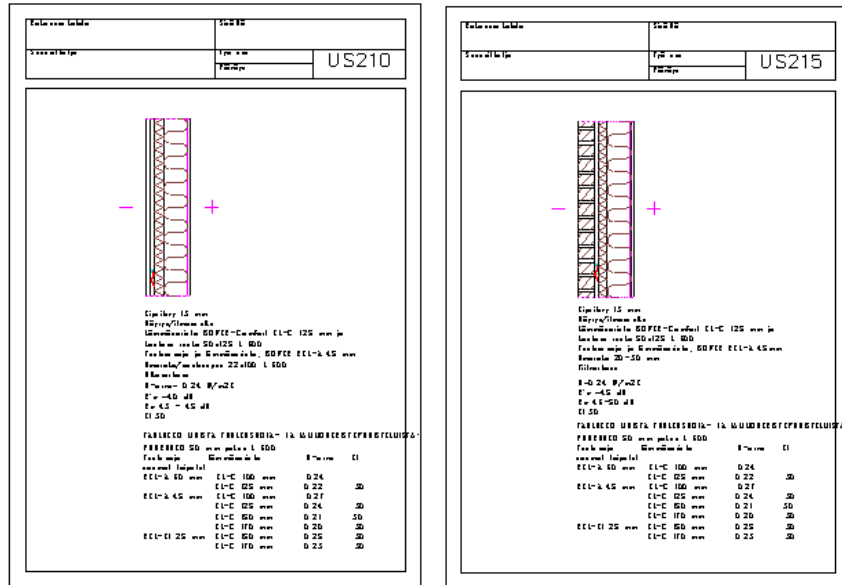

FIG 8 External Wall

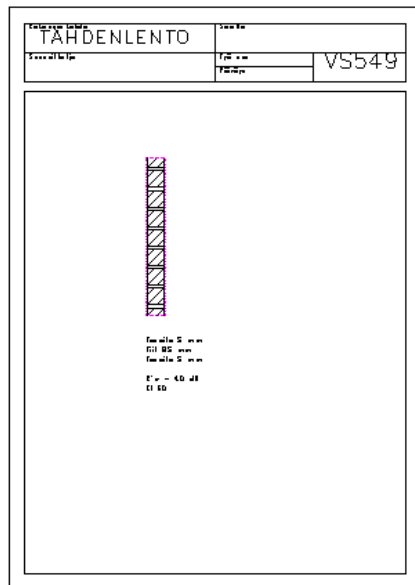

FIG 9 Partition Wall

The Single Occupancy Building Designs

The Building Designs include e.g. permit drawings, implementation drawings and master documents. The permit drawings contain site plan, plans, sections, elevations and building component documents. Implementation drawings include detailed plans, sections, window and door lists, furniture drawings and detail drawings. Next we study a timber frame single occupancy designs.

- 11.360 Permit drawings
- 11.362 Site plan
- 11.363 Plans

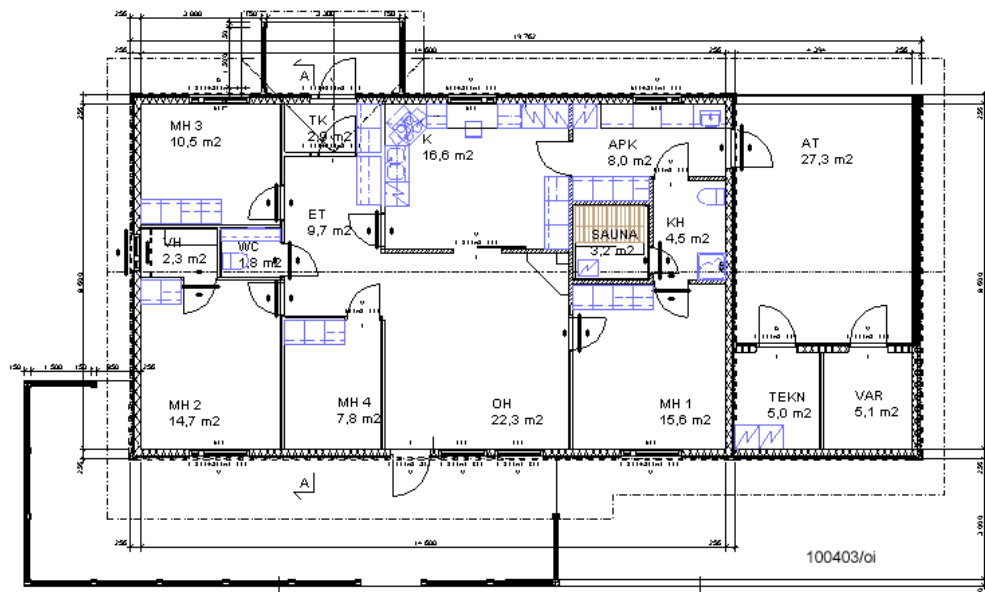

FIG 11 Single Occupancy Architectural Plan

The Single Occupancy Plan Drawings

The plan drawings are usually in scale 1:100 – 1:50.

Assignment

Present the design criterias of the rooms and furniture

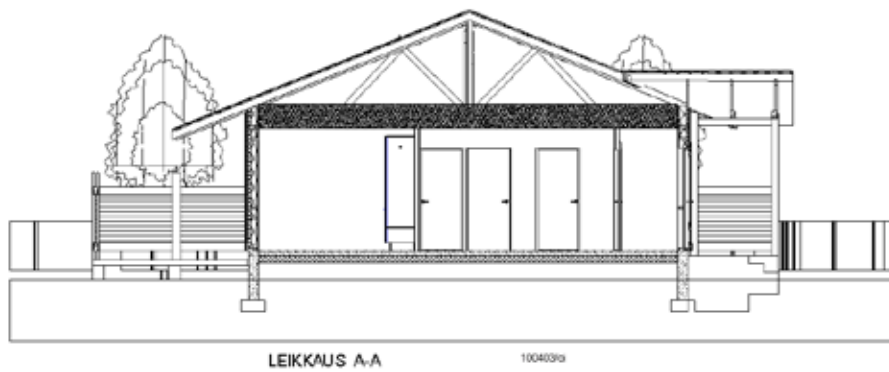

FIG 12 Section A-A

The sections

The Permit Drawing Sections are usually in scale 1:100.

Assignment

Explain the content of the permit drawing sections

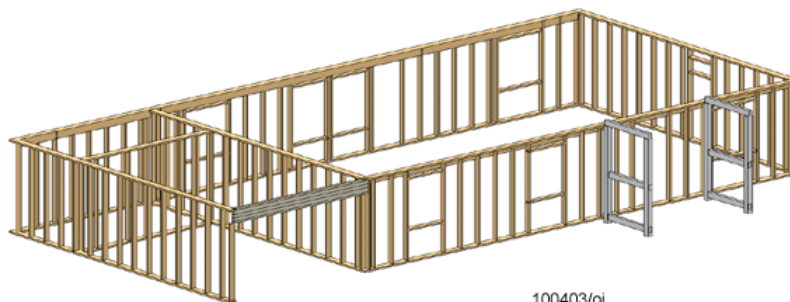

FIG 15 Frame Axonometry

1.2 The Single Occupancy Structural Design

The Structural Design includes optional frame solutions, load calculations, foundation design, building components, roof structures and specifications with other collaborators. The Single Family House can be built up e.g. in situ, with concrete unit structures or as a timber-, brick-, concrete- or steel frame building. The structural designs include e.g.

- 11.40 Project information
- 11.41 Structural calculations
- 11.42 Building Components
- 11.43 Frame
 - 11.430 Plan Drawings
 - 11.431 Sections
 - 11.432 Details
 - 11.433 Lists and specifications
- 11.44 Elevations
- 11.45 Foundation Designs
- 11.46 Frame components
 - 11.461 Stairs
- 11.47 The Roof Structures Vesikatto-ja täydentävät rakenteet
- 11.48 Specifications



100403/oi

FIG 16 Single Occupancy Frame

Plans and Projections

The timber frame is designed with plans and projections.

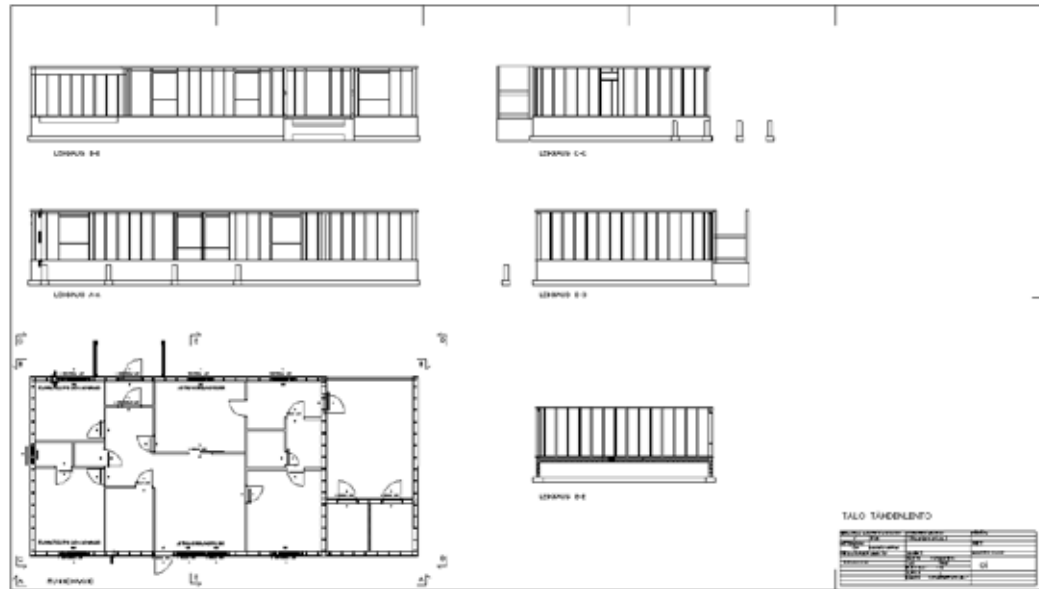

FIG 17 Single Occupancy Timber Frame

Foundations

The basement is designed under the bearing frame of the residential floor. The loads are carried by the bearing structures to the foundation and again to the soil. The foundation type can be e.g. strip foundation or pile foundation depending the properties on the ground.

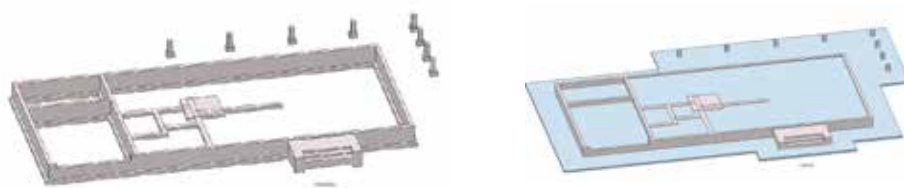

FIG 18 Strip Foundation

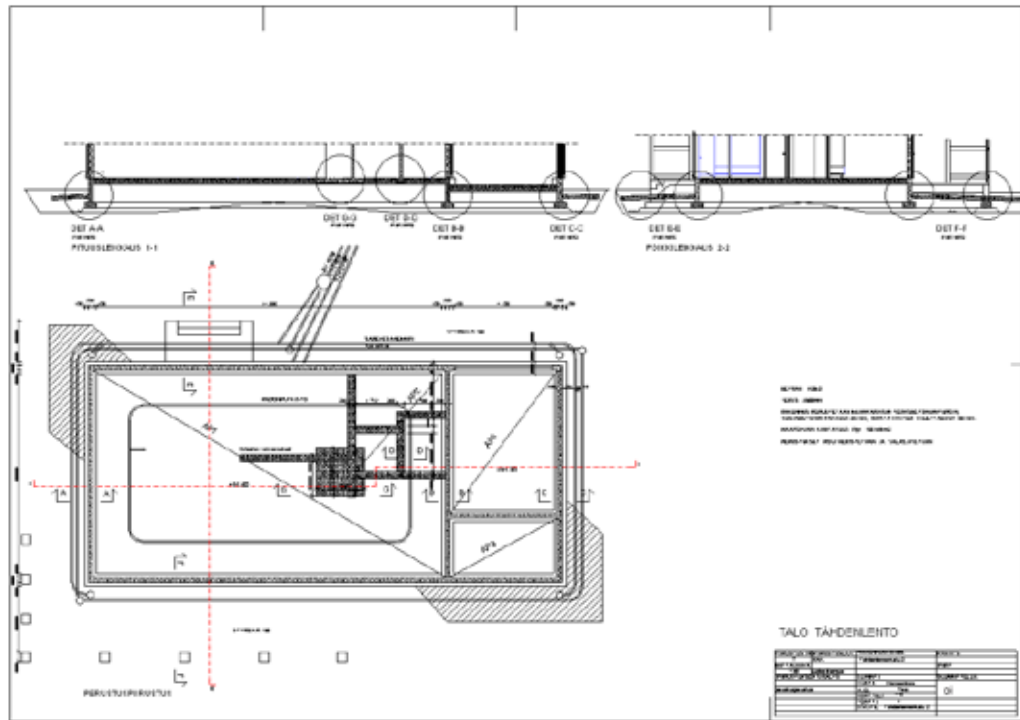

FIG 19 Single Occupancy Foundation Plan

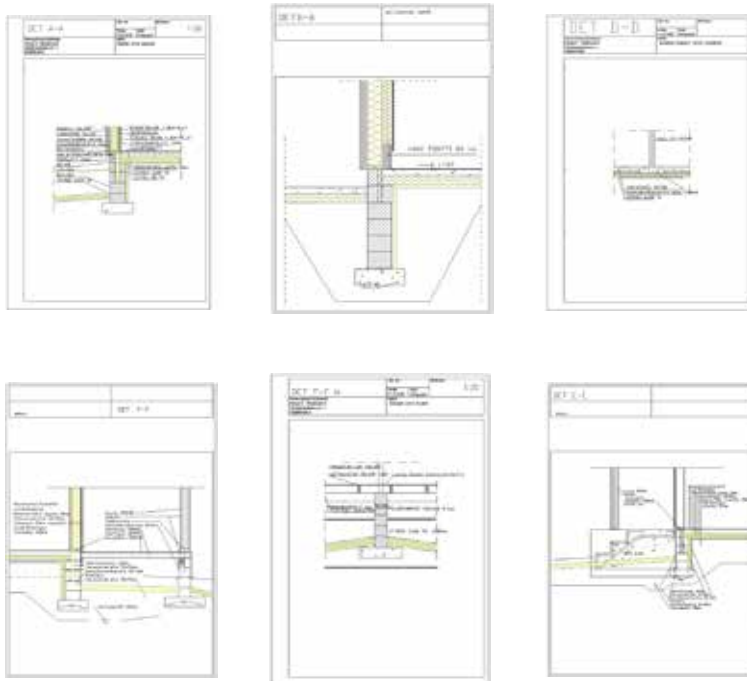

FIG 20 Foundation Sections

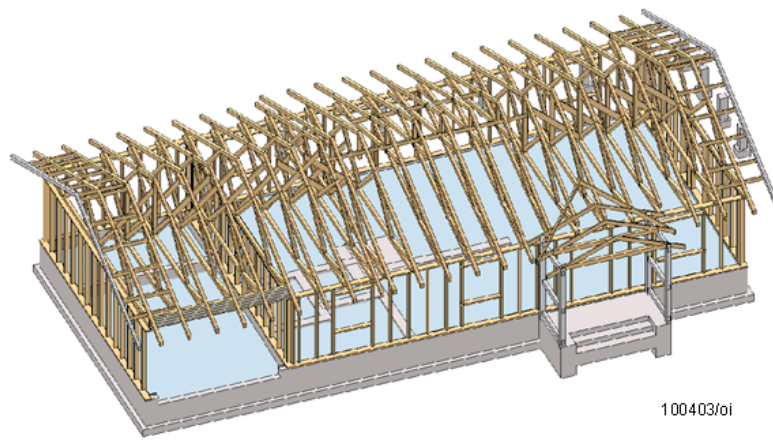

FIG 21 Single Occupancy Roof Structure Layout

The Roof Structure Designs

The Roof Structure Designs include e.g. timber truss layout, eave details and truss types

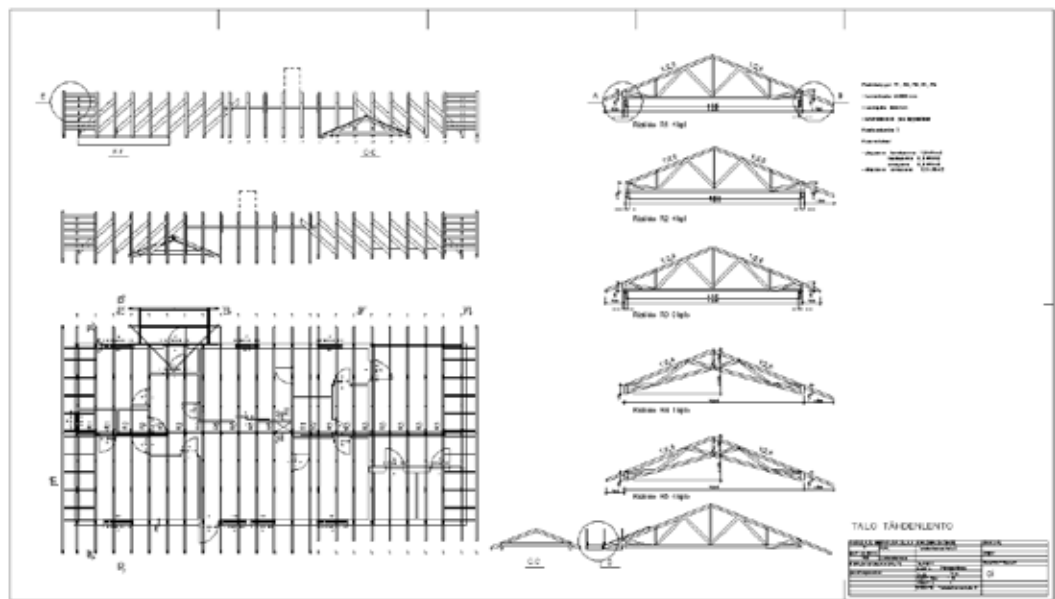

FIG 22 Roof Truss Designs

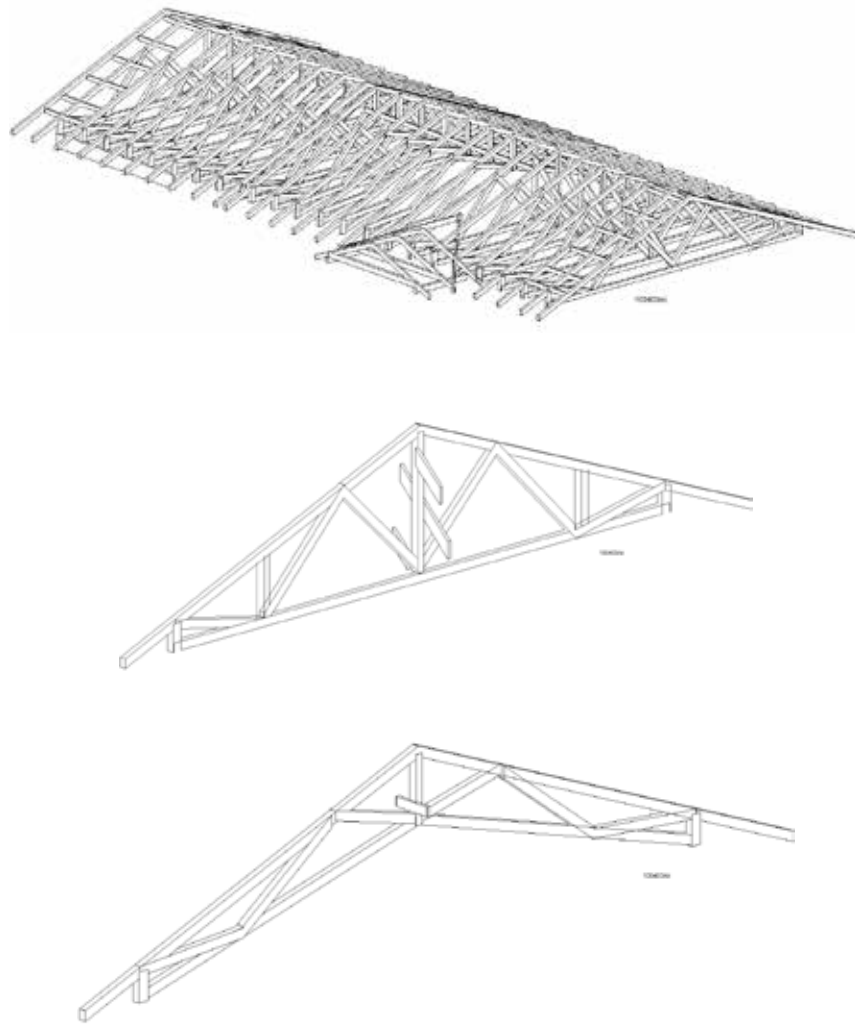

FIG 23 Roof Structures

1.3.1 Building Information General



FIG 25 Presentation of the ProIT programme about BIM /24/

1.4 CASE: ArchiCad- modelling



FIG 26 Proit- Building

The modelling of the Proit house is practised with a ArchiCad programme. Check ArchiCad manuals

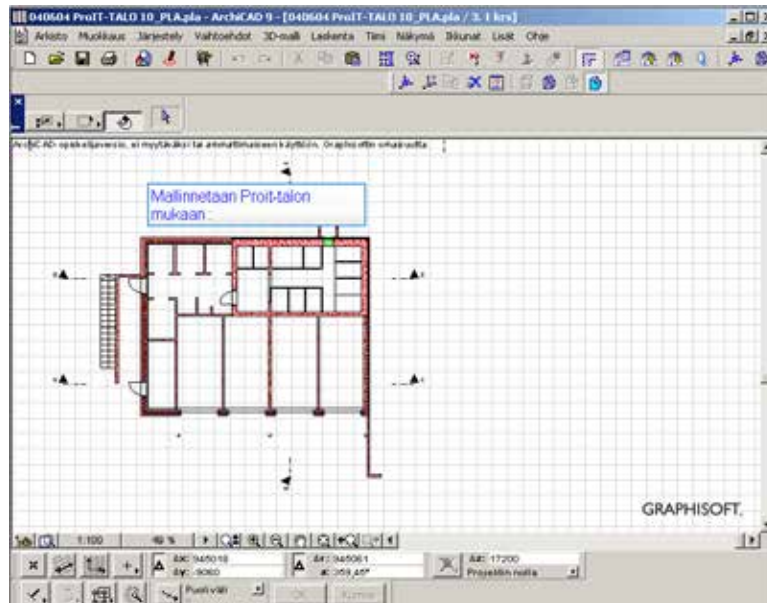

FIG 27 Modelling of the Proit house

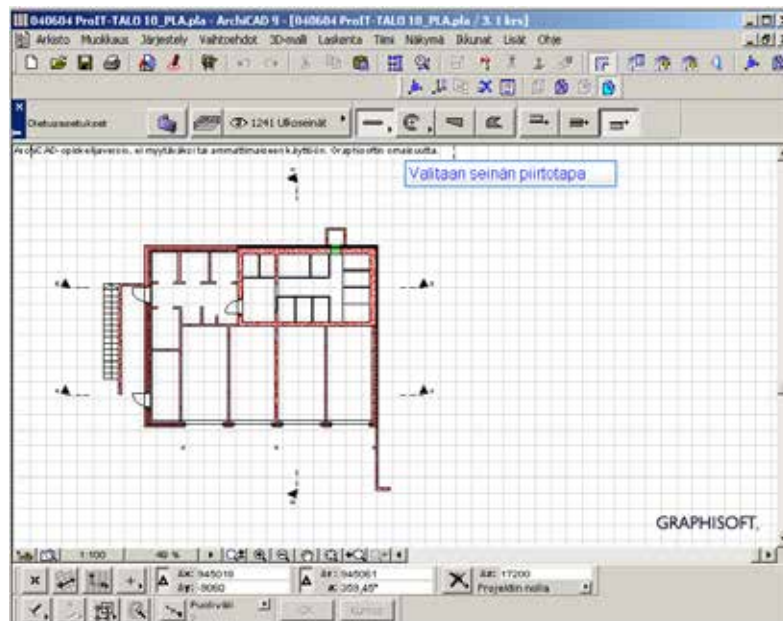

FIG 28 Modelling of the wall

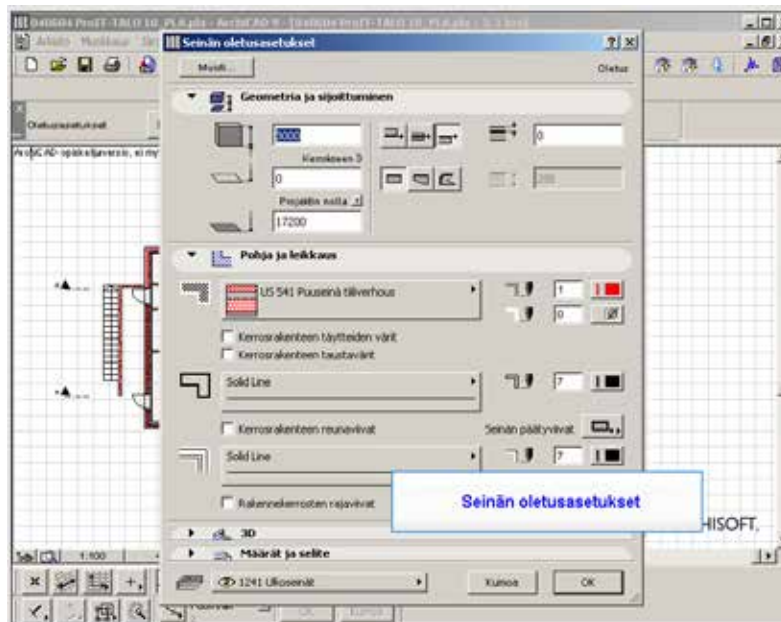

FIG 29 Settings of the wall

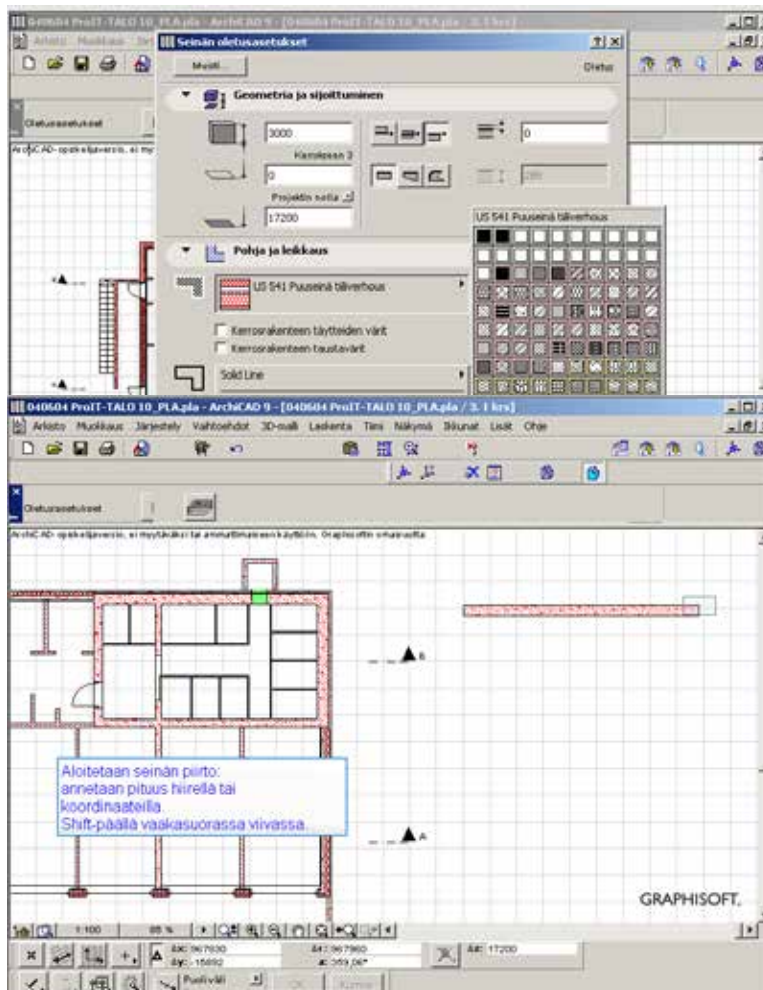

FIG 31 Modelling the basement wall

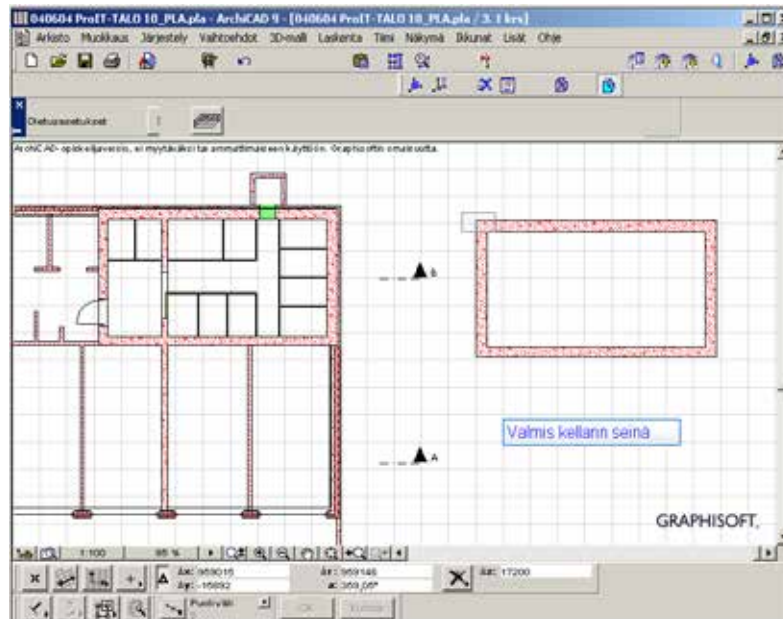

FIG 32 Finishing the wall

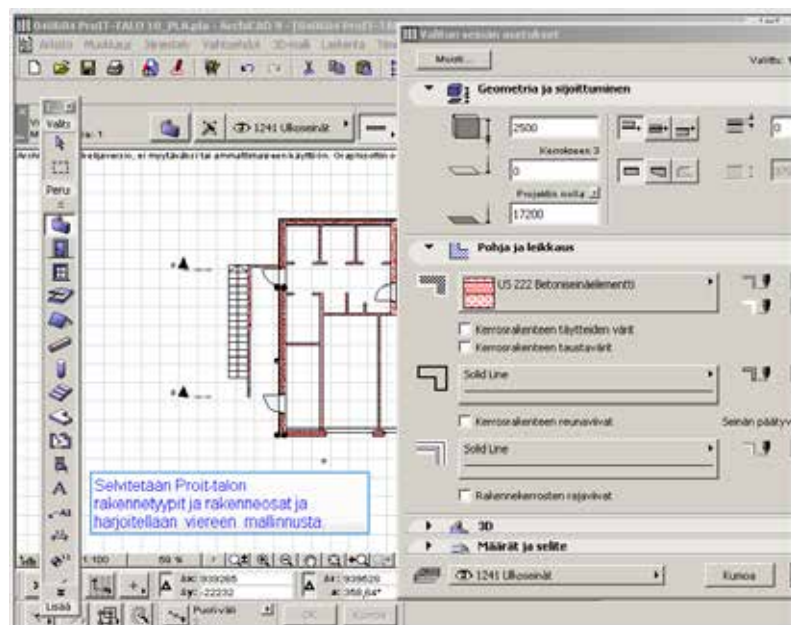

FIG 33 Checking the wall properties

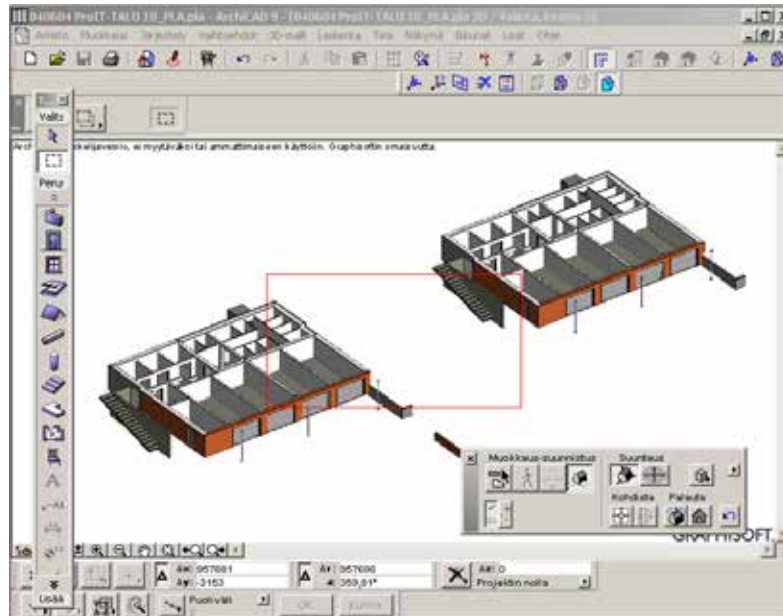

FIG 34 Modelling the rest

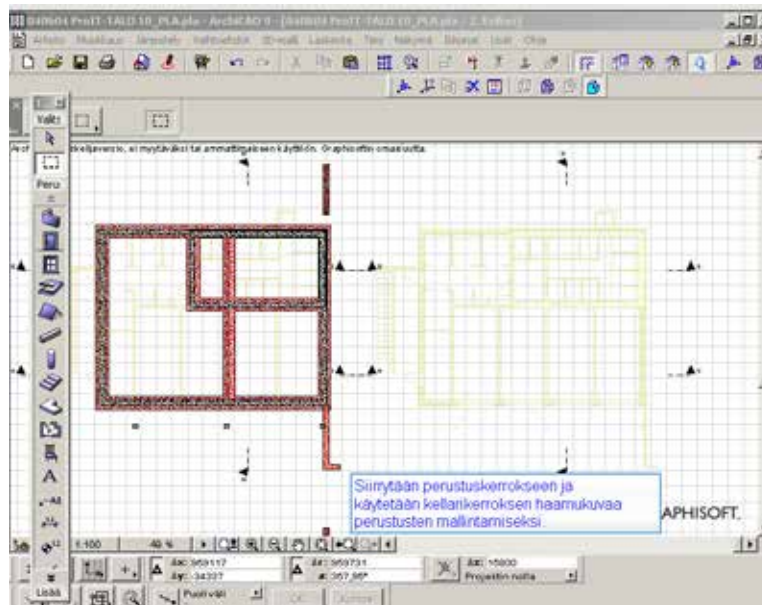

FIG 35 Basement modelling

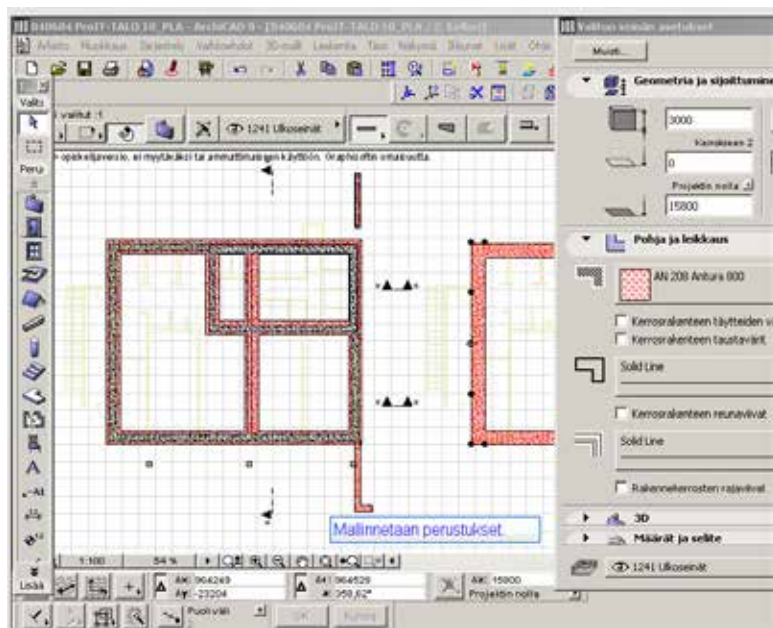

FIG 36 Basement Modelling

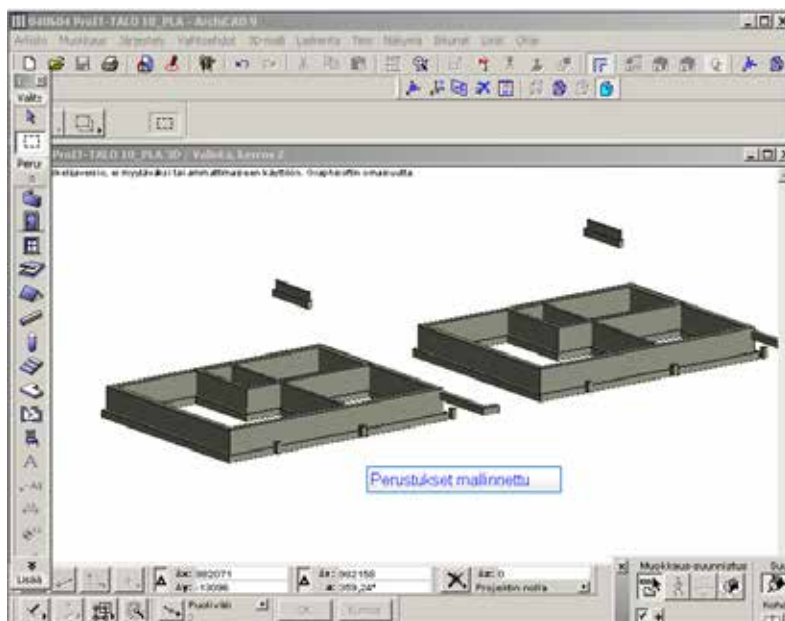

FIG 37 Basement Modelling

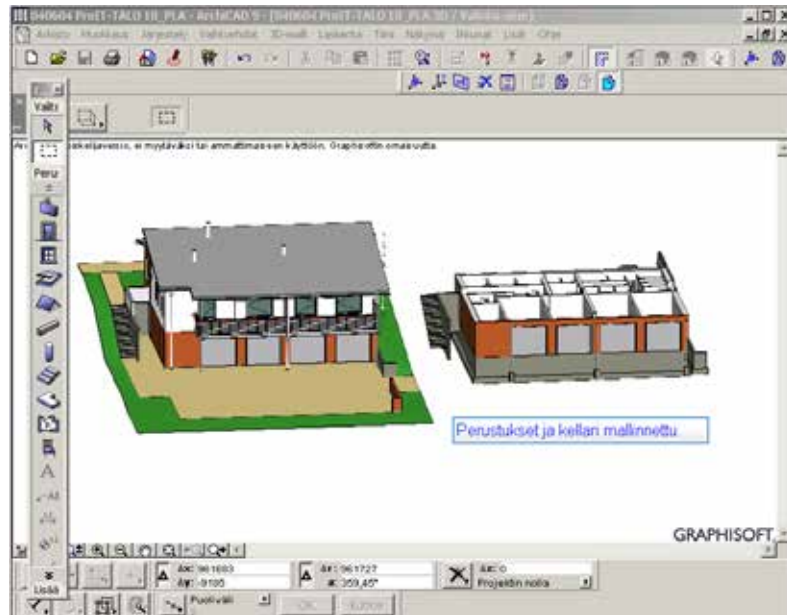

FIG 38 Basement Modelling

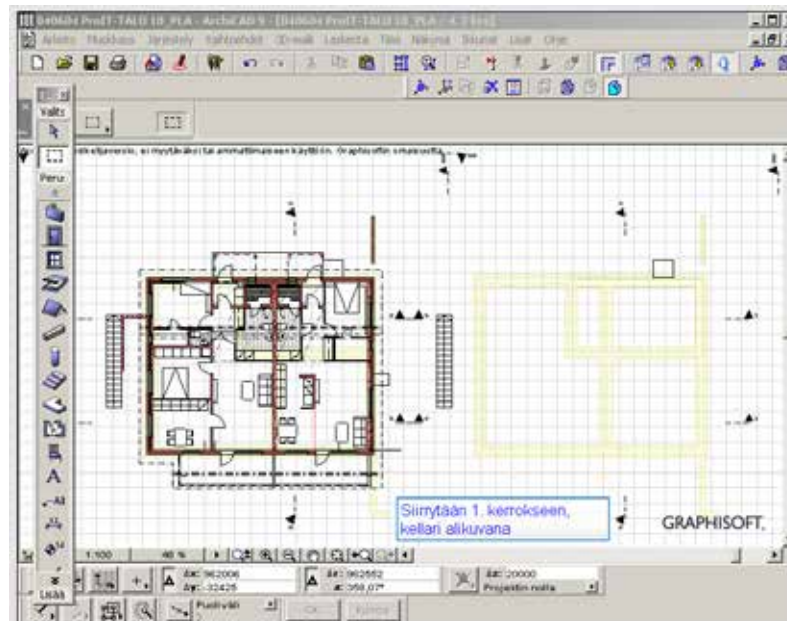

FIG 39 First Storey Modelling

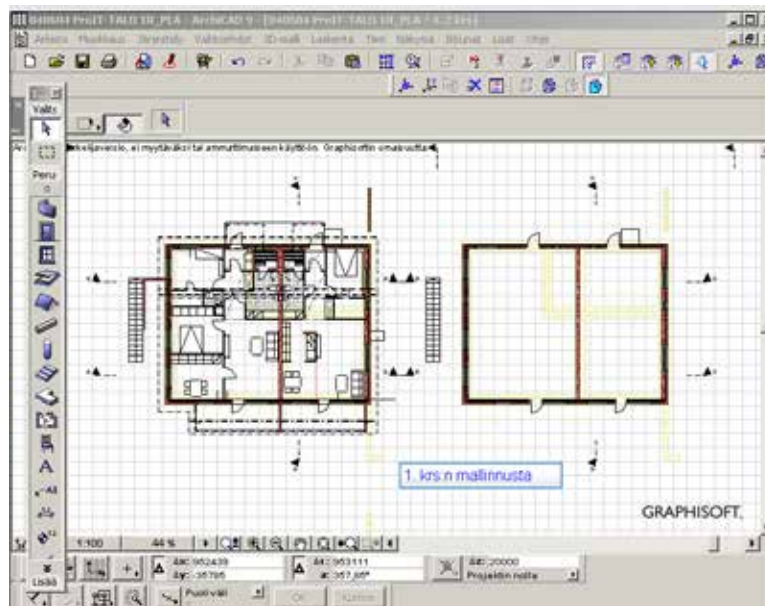

FIG 40 First Storey Modelling

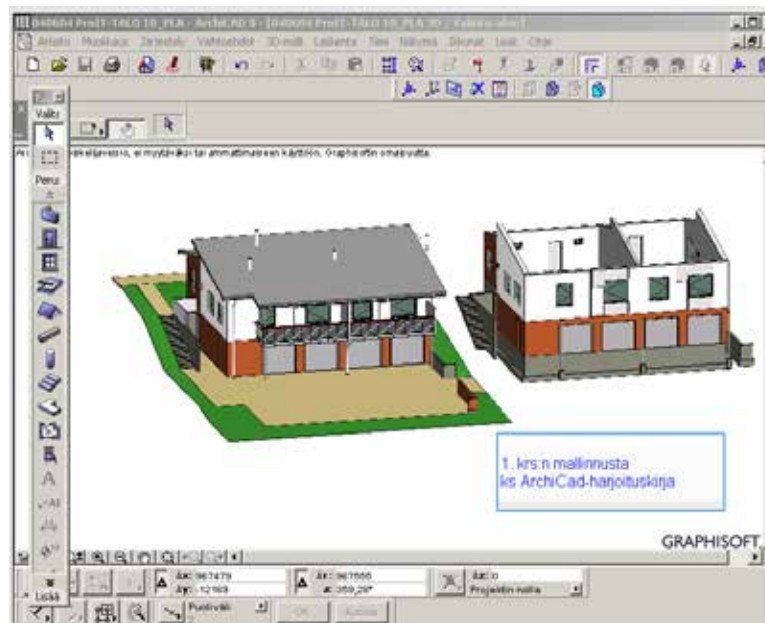

FIG 41 First Storey Modelling

1.4.1 BIM Building Information Modell and the drawings

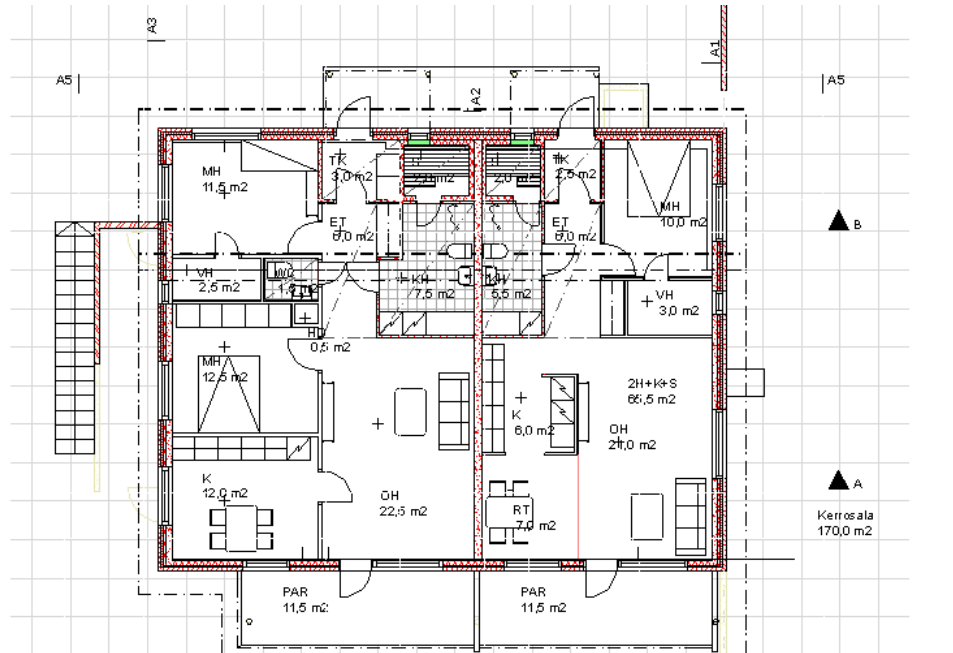

FIG 42 First plan drawing

Complete the drawing to match the permit drawing requirements

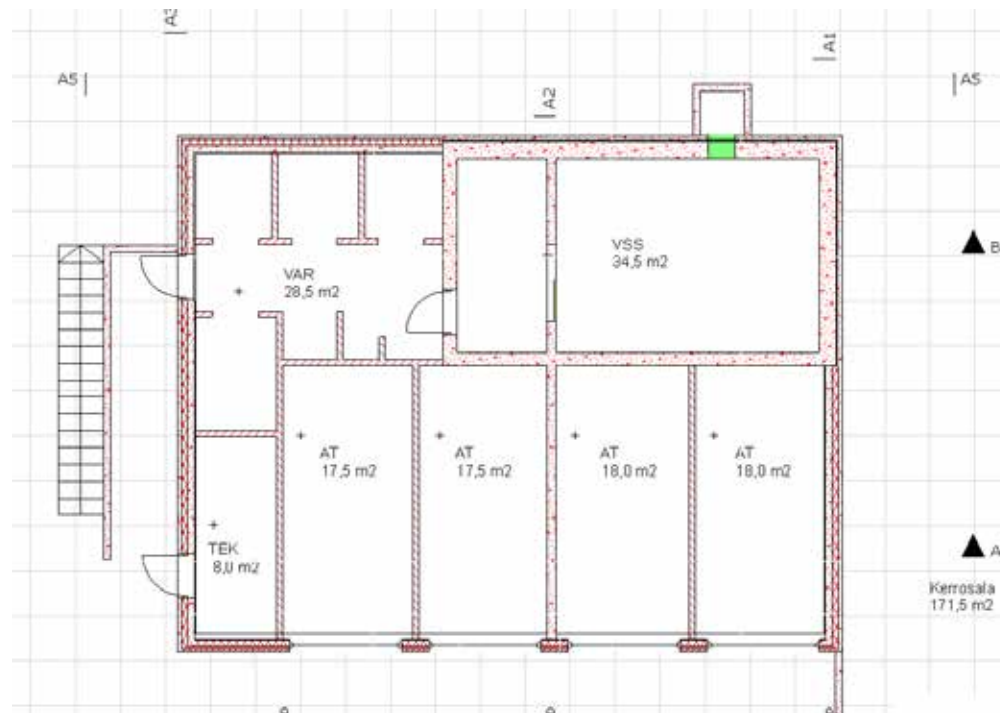

FIG 43 Basement Drawing

Complete the drawing to match the permit drawing requirements

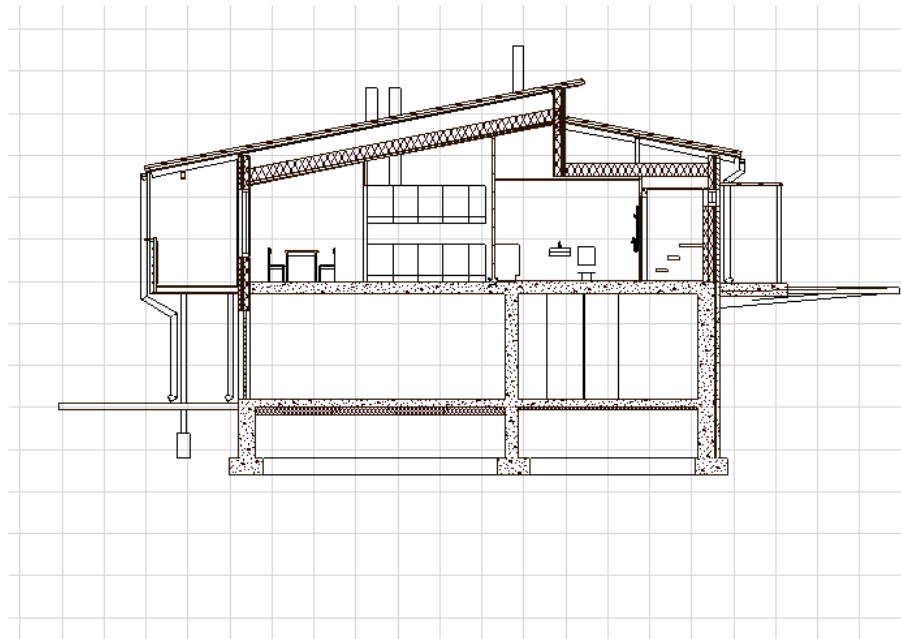

FIG 44 Section A-A

Complete the drawing to match the permit drawing requirements

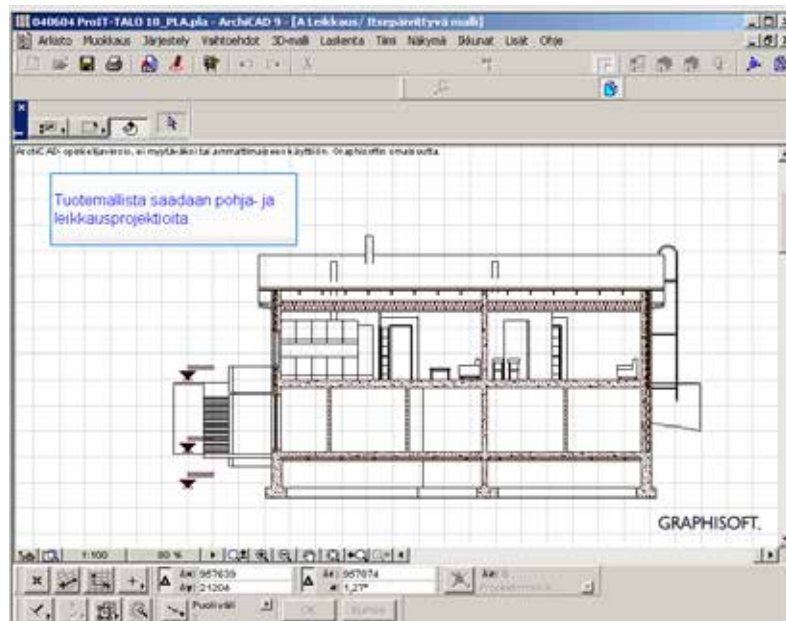

FIG 45 Section B-B

Complete the drawing to match the permit drawing requirements

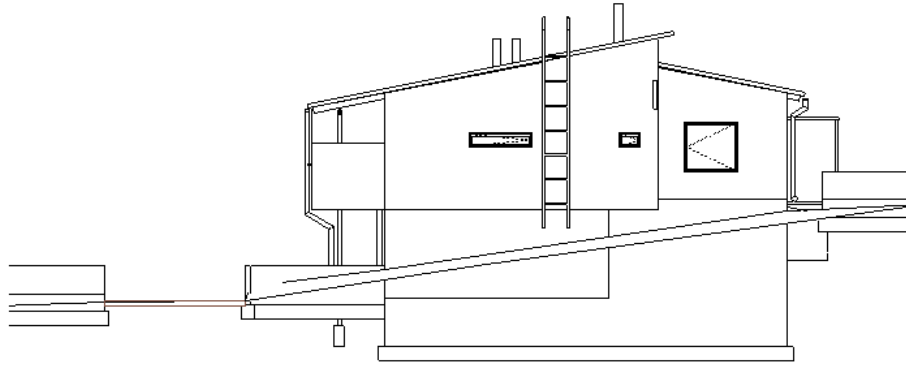

FIG 46 West Elevation

Complete the drawing to match the permit drawing requirements

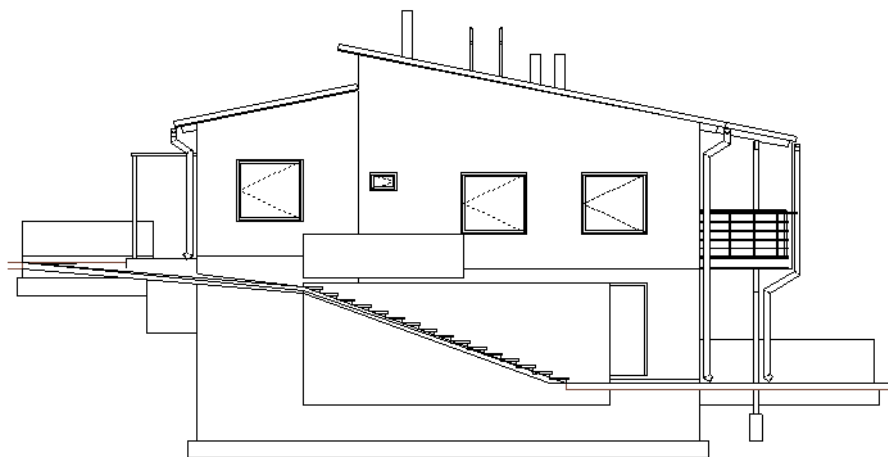

FIG 47 East Elevation

Complete the drawing to match the permit drawing requirements

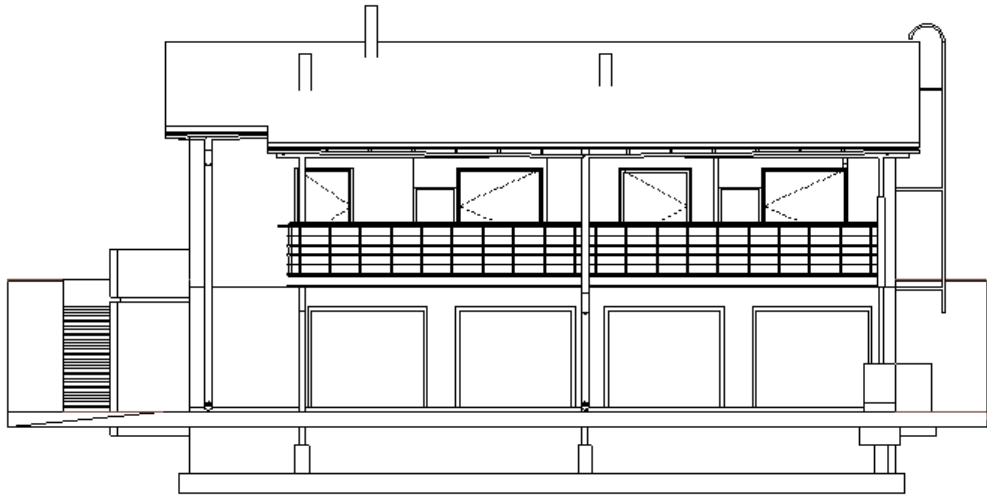

FIG 48 South Elevation

Complete the drawing to match the permit drawing requirements

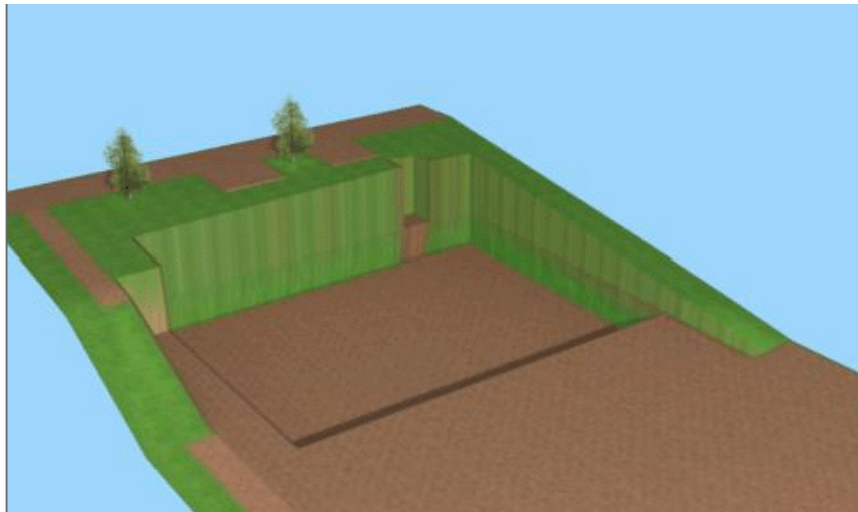

FIG 49 Excavation

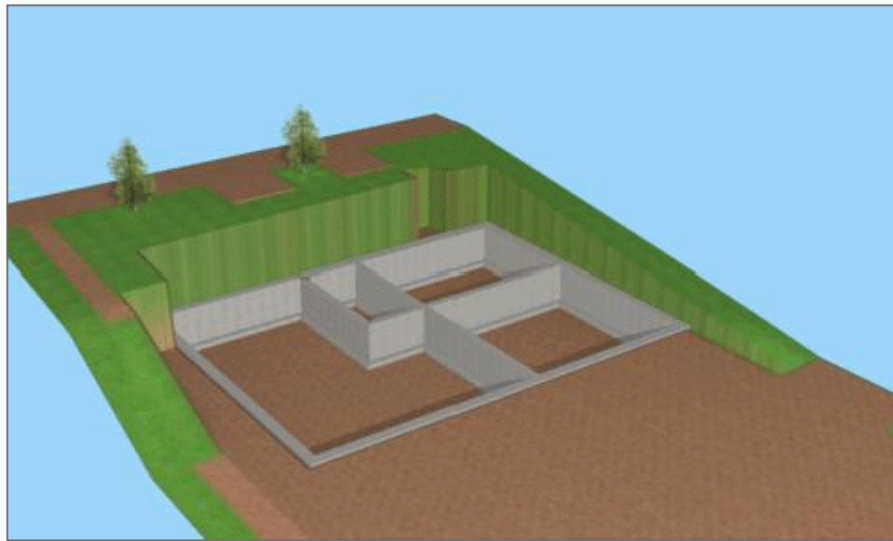

FIG 50 Foundations of the basement

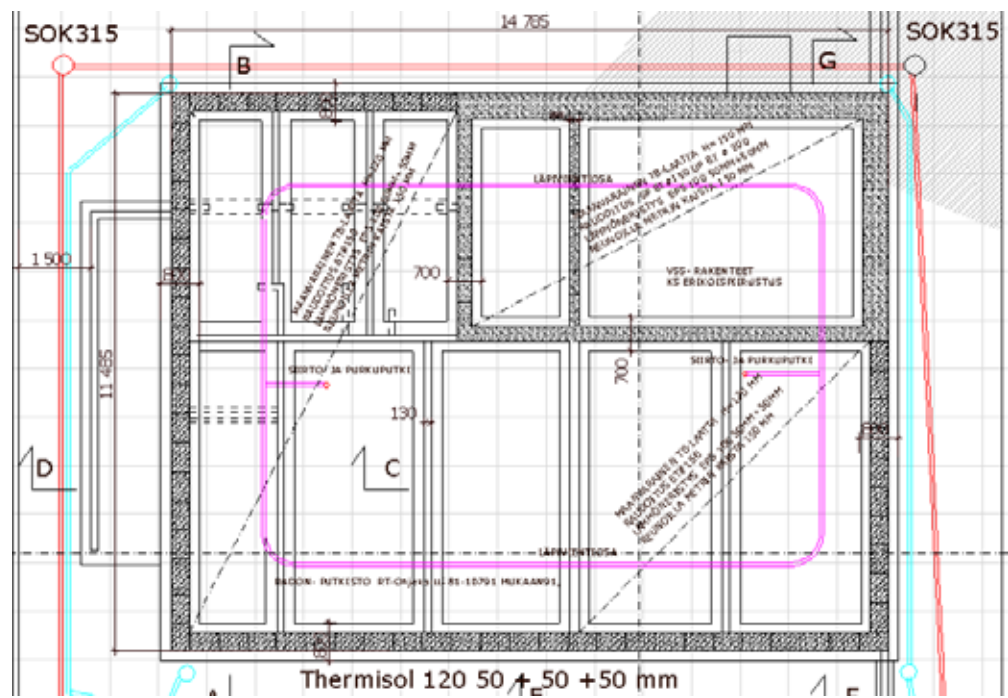

FIG 51 Foundation Plan

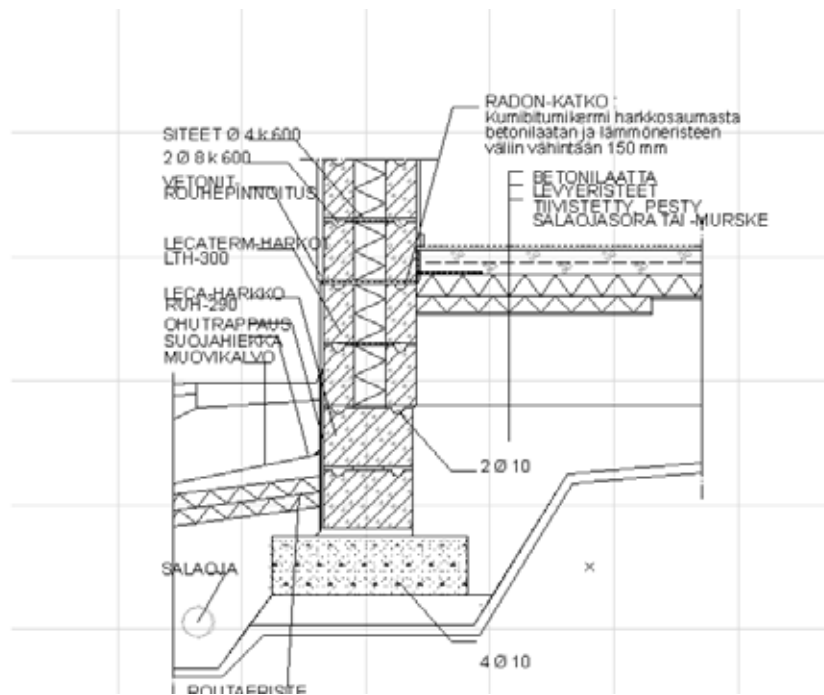

FIG 52 Section Detail

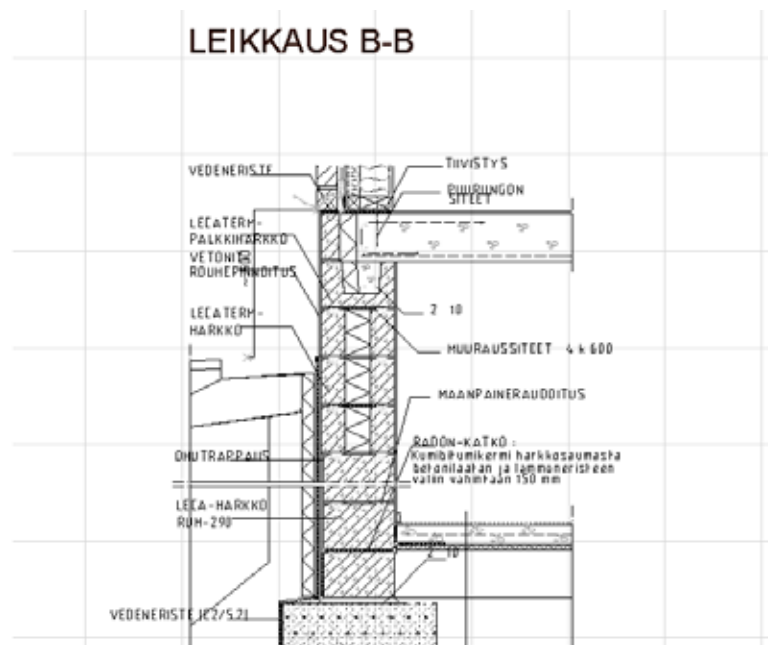

FIG 53 Section Detail

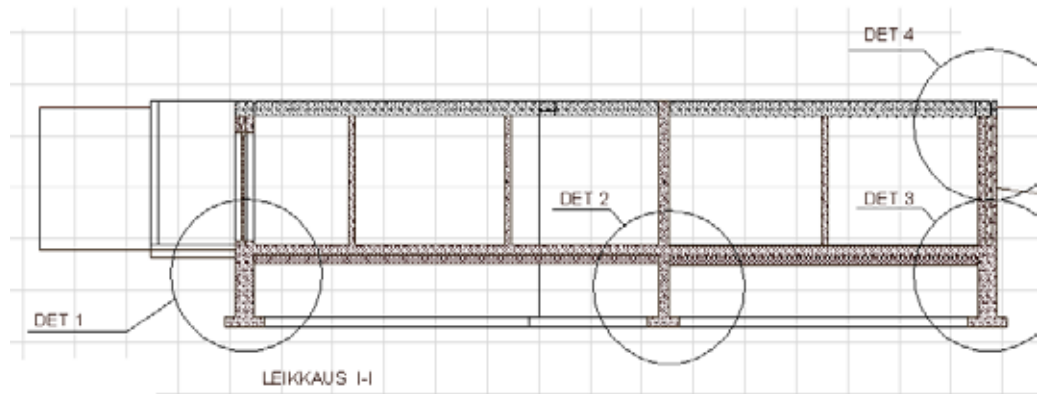

FIG 54 Longitudinal Section A-A

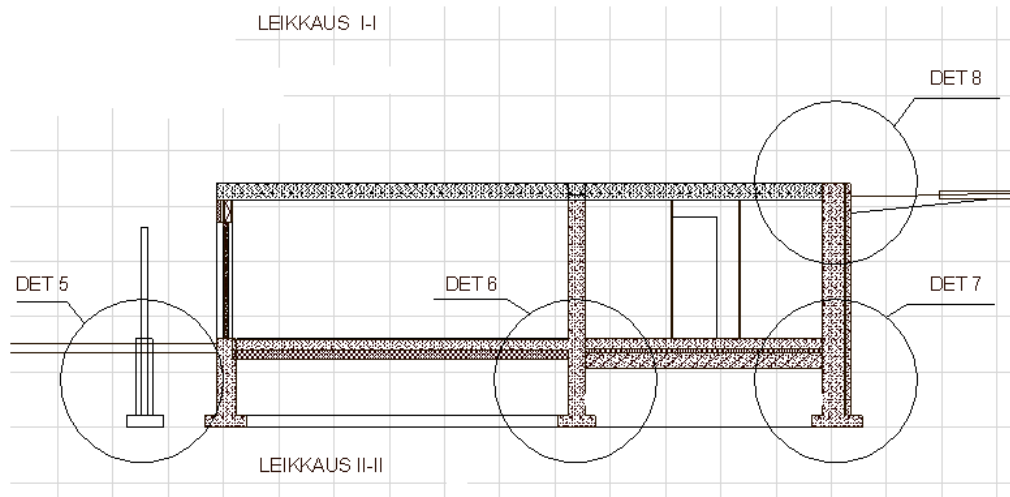

FIG 55 Transversal Section

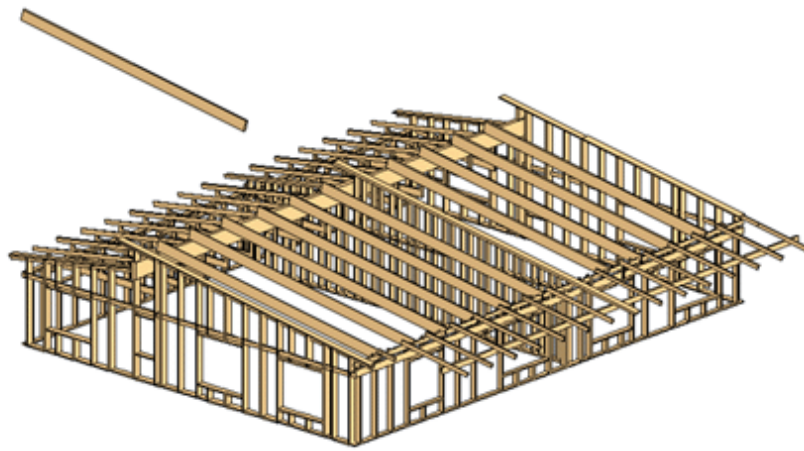

FIG 56 The Timber Frame

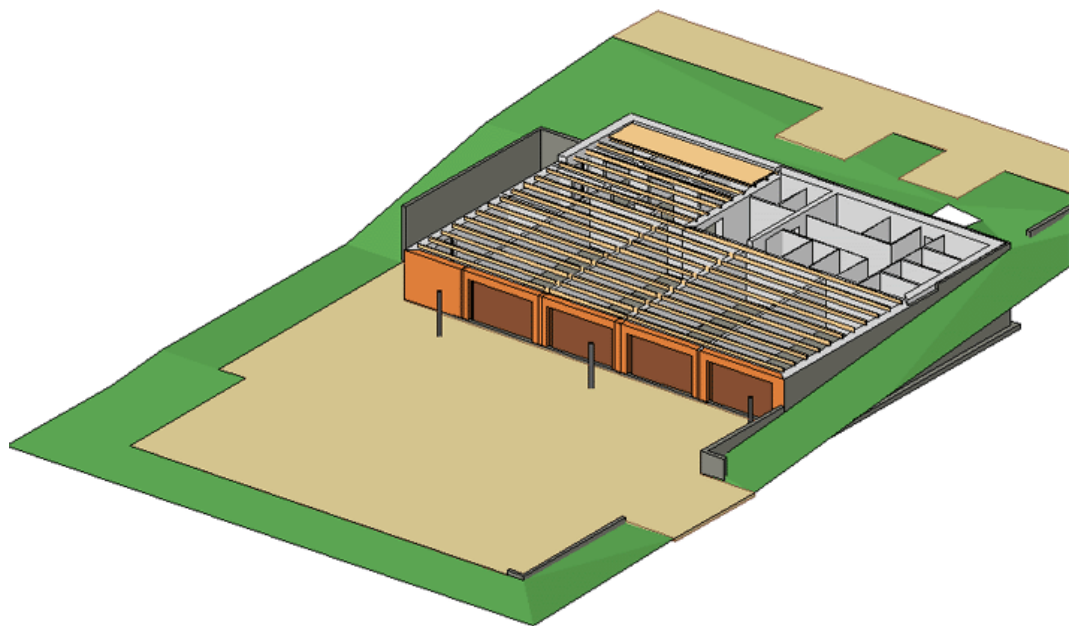

FIG 57 The Timber Floor

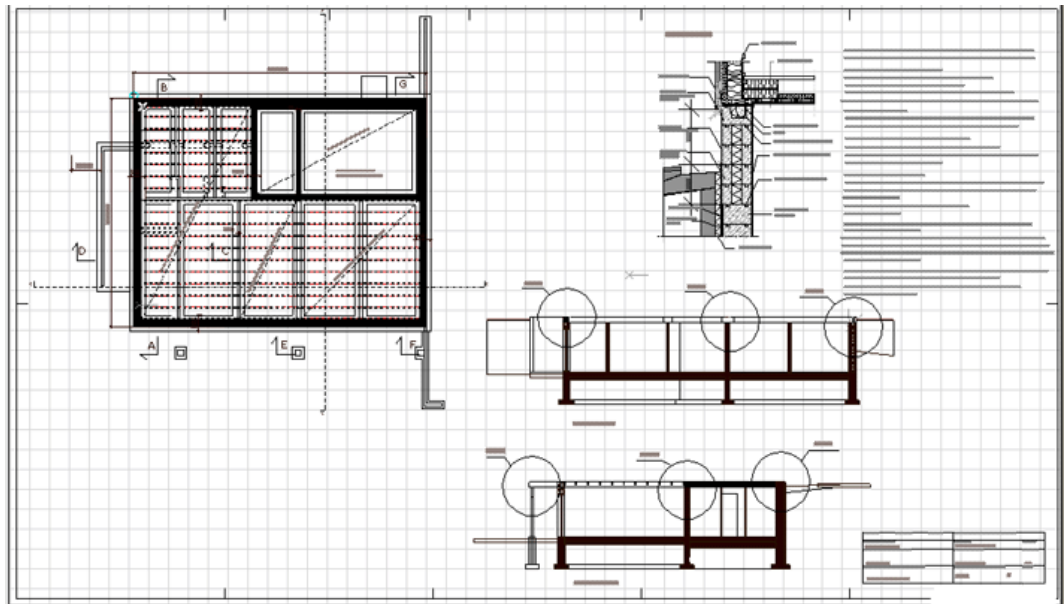

FIG 58 Timber Floor Plan and Sections

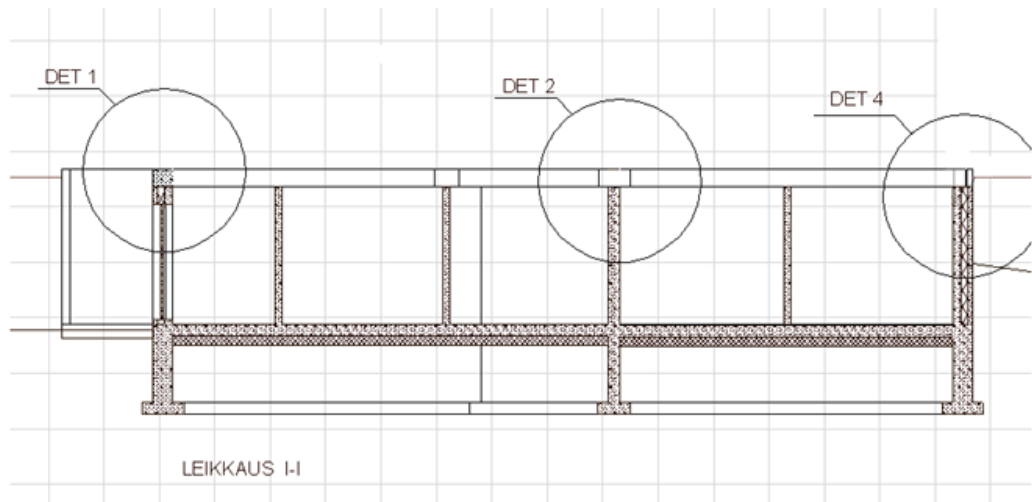

FIG 59 Timber Floor Plan and Details

Complete to match a Structural Design

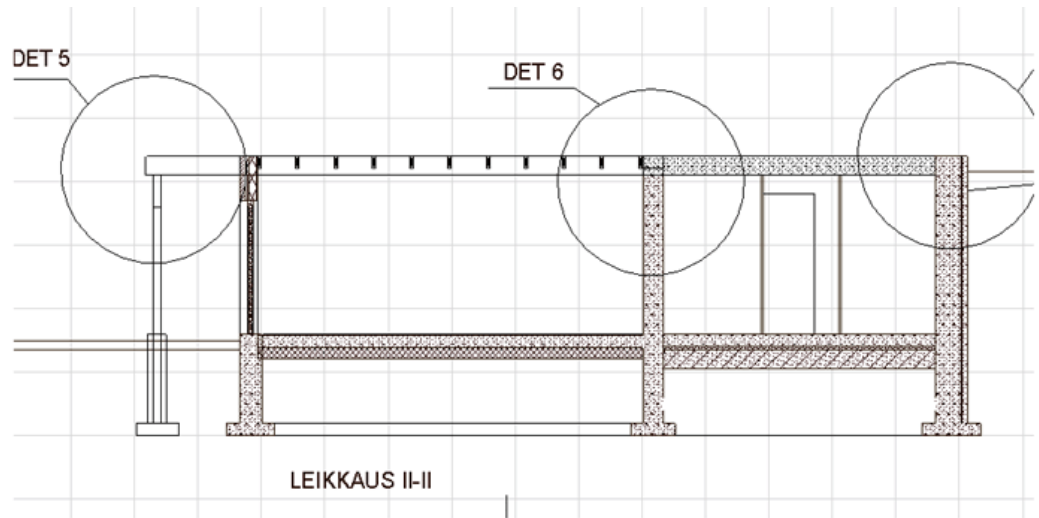

FIG 60 Timber Floor Plan and Sections

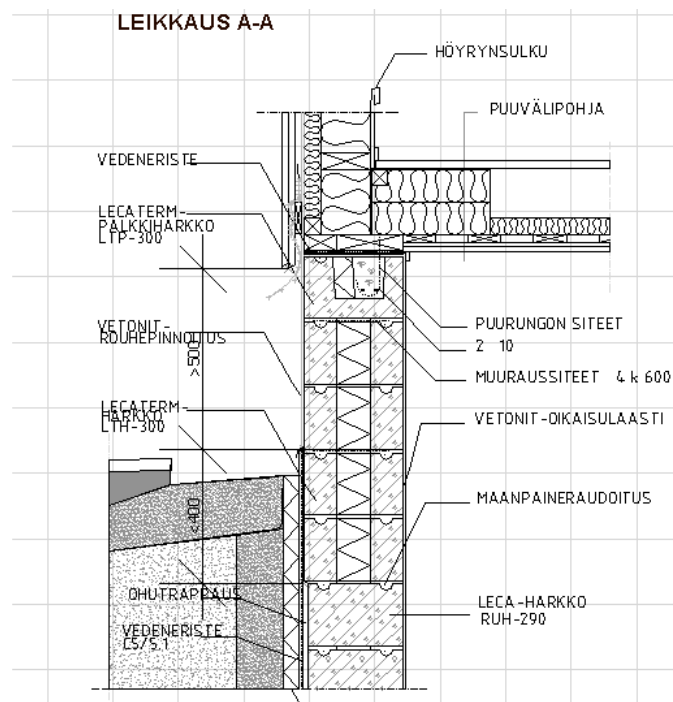

FIG 61 Timber Floor Detail



FIG 62 Roof Structure options: Beam or Truss

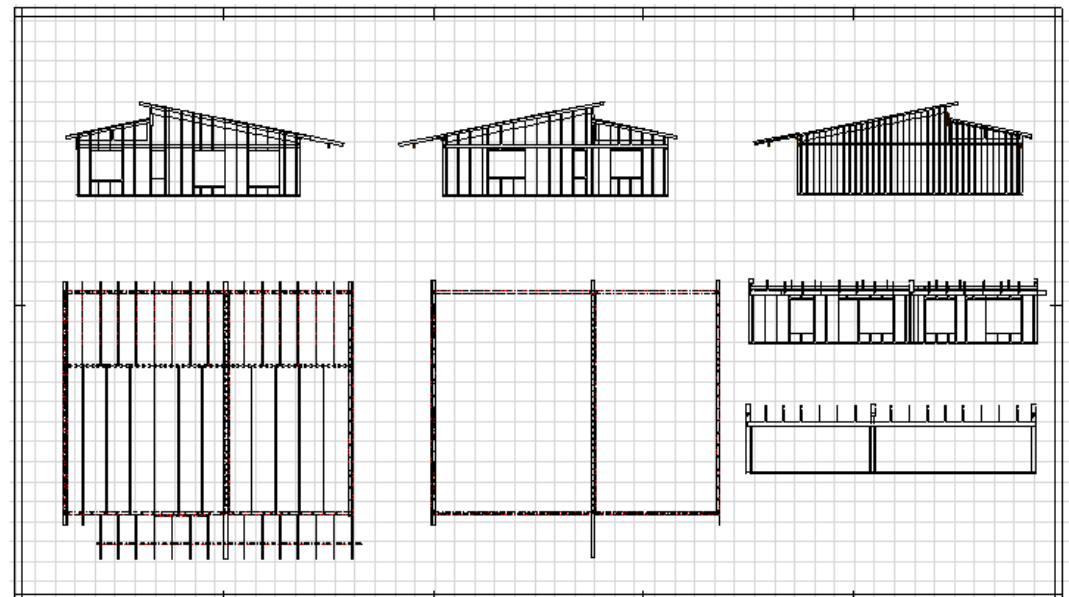

FIG 63 Timber Frame Plan and Projection designs

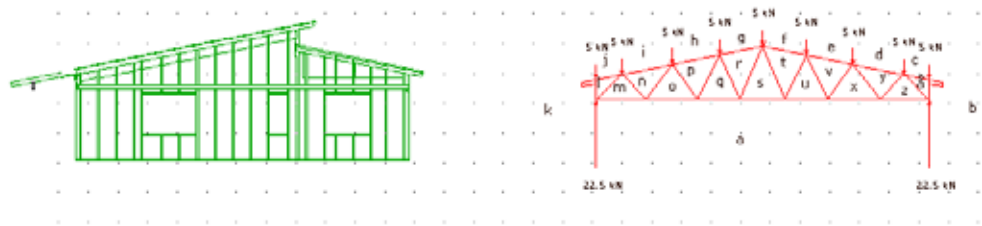

FIG 64 Timber Truss Option

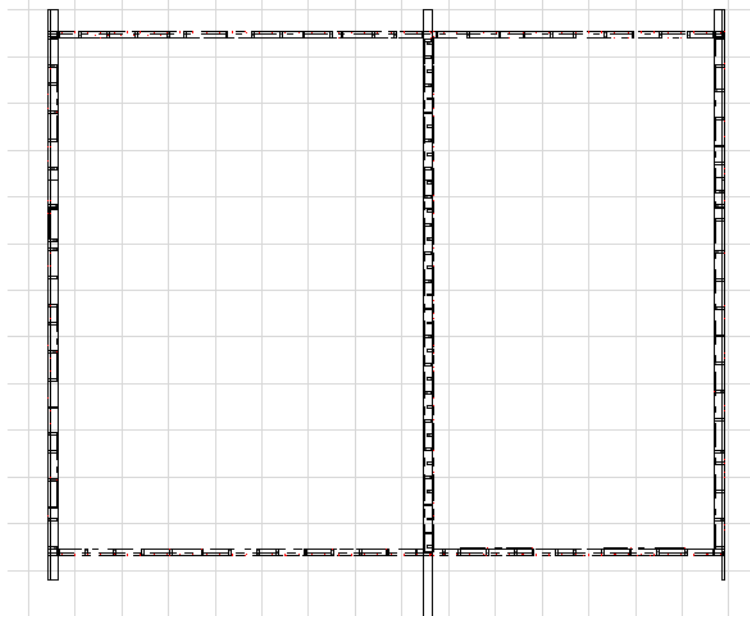

FIG 68 Timber Frame Plan

Complete to match a Structural Design



FIG 69 Timber Frame Plan

Complete to match a Structural Design



FIG 70 Timber Frame Plan

Complete to match a Structural Design

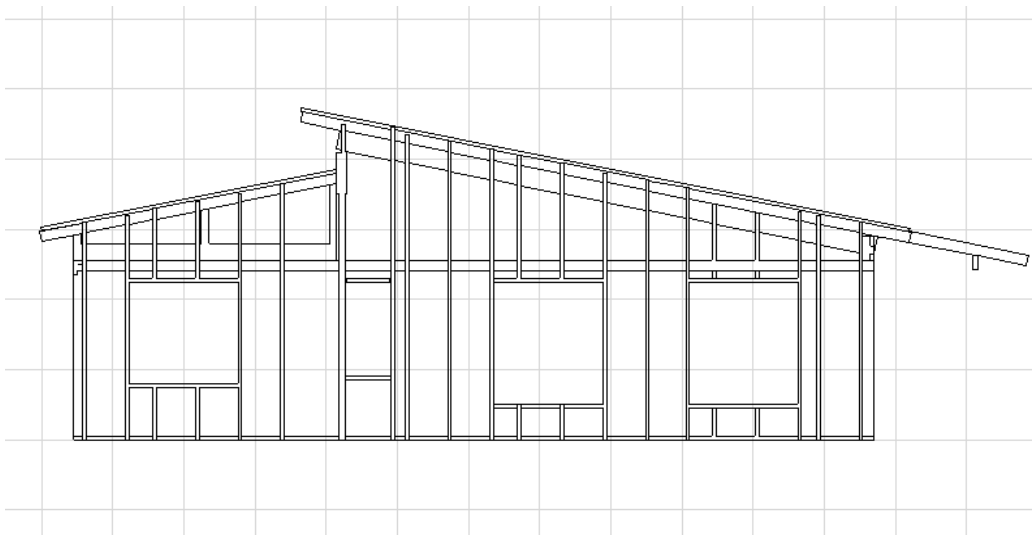

FIG 71 Timber Frame Plan

Complete to match a Structural Design

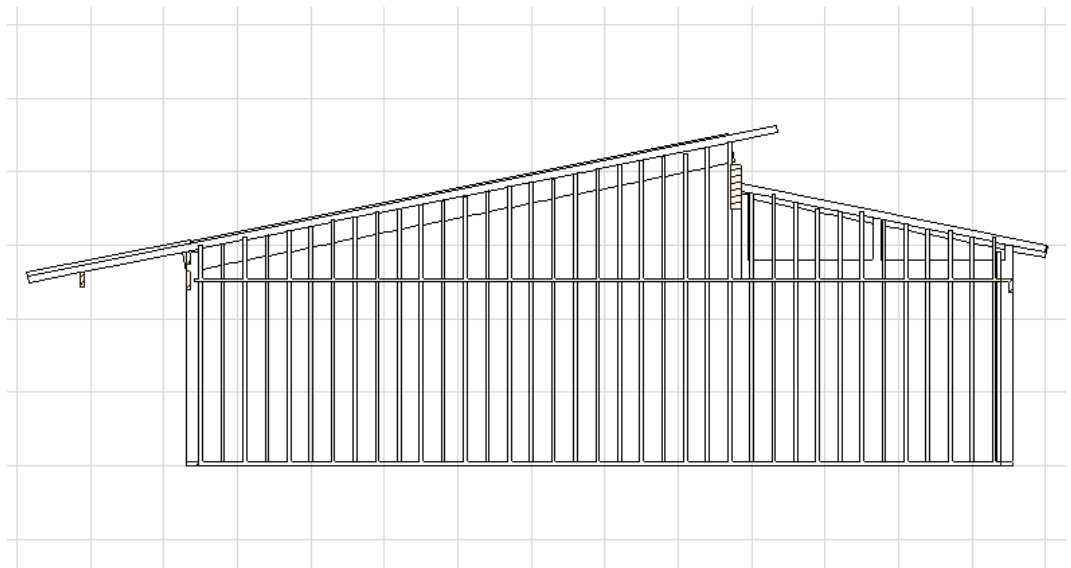

FIG 72 Timber Frame Plan

Complete to match a Structural Design

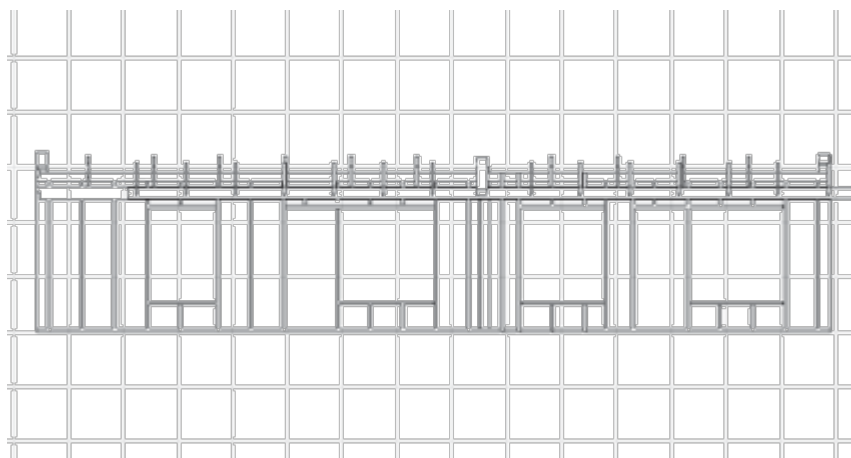

FIG 73 Timber Frame Plan

Complete to match a Structural Design



FIG 74 Timber Frame Plan

Complete to match a Structural Design

2 The Building Process Guidelines

/3/

2.1 Guidelines

2.1.1 The Land Use and Building Act

The legislation concerning Finland's The Land Use and Building Act reformed on the whole in the year 2000. The new The Land Use and Building Act (MRL) encourages the citizens and of other interest groups to participate in the planning process, the quality of the planning and the building and the principles of the sustainable development.

The Hierarchical Plan System

The planning system of Finland's land use contains three hierarchical levels : regional plan, local master plan and local detailed plan.

The regional plan shows the principles of the land use and urban structure of areas for the whole region. It's important task is to fit the national objectives together with the needs for the region. The region plan becomes valid only when the Ministry of the Environment has strengthened it. There are altogether 19 regions and their areas cover the whole country.

The urban structure is directed with the master plan. The areas are divided to different purposes in the town planning. The master plan is designed and approved locally. The environmental administration of the country will participate in the control of the general planning and a complaint about the master plan can be made to the court.

The objectives of the plan system apply to the regional structure of the country, the quality of the environment, the a cultural heritage and natural resources, the important road connections or track connections and the energy management. On the countryside a plan is not needed outside the densely populated areas as a precondition for the building but the municipality can have orders on the minimum size of the building site or for example on the minimum distance of the building to the neighbour's limit. If the building does not cause a drawback to the future planning the building permit can be granted.

The control system of the construction

The land use and the building act emphasises the quality, environmental values and the sustainability. There must be a building surveyor in every municipality. The constructor must make sure that the regulations concerning building are observed and therefore he must have skilled designers and the supervisor of the building work available according to the law.

The permission which the municipality admits is needed for the building. The plans of the building must be based on the plan of the area and on other building regulations given by the municipality. The plans, of course, also must meet the demands of the building regulations of the Land Use and Building Act.

New measures of the Land Use and Building Act that secure the quality of the building are the Beginning Meeting of the Building Work, the Inspection Documents and the Service Instruction of the Building.

2.1.2 Forms of the Building Permit

The Building Permit Application process consist e.g. the following :

- Building Permit Application
- The Foreman's Application
- Designer's Application
- The Informing of the neighbour
- Announcement of apartments RH2
- Announcement of Rakennushanketieto RH1

Forms of the Inspection of the building

The Quality Control consists e.g. the following measures:

- Inspection of the Damp Space Structures
- Announcement from the Bomb Shelter
- Application of the Acceptance of the Assembly Room
- Persons in charge of the Control
- Report on the waste management of the demolition work
- Report on the handling of construction waste

2.1.3 Content of YSE 1998 General Agreement Conditions

The YSE 1998 the General Agreement Conditions are basis for the main and subcontracts. It creates the rules between the actors in the construction process. /19/

Parties of the contract

Constructor: natural or judicial person on whose account the building work is done and which ultimately receives the work result.

Subscriber: the contractor's contracting party which has ordered the contract performance. The constructor or the contractor can serve as the subscriber.

Contractor: the subscriber's contracting party which has bound itself to accomplish the work result that has been defined in the contract documents.

Main contractor: contractor in the contractual relation who in commercial documents has been named as a main contractor and on which the constructor includes the management duties of the site in a contractual scope.

Contractor: constructor contractor in the contractual relation who carries out the work which does not belong to the main contract.

Subcontractor: from the contractor's order the second contractor who carries out work.

When agreements, site document, claims et cetera are drawn up, these must be consequentially made according to YSE to avoid misunderstandings, the parties' names which are in accordance with the concepts.

Other important concepts in YSE:

It is worth to pay attention especially to the following concepts: Risk (YSE 55 §), Alteration work – extra work (YSE 43 – 46 §) and Inspection of the contract performance – Handing Over Inspection (YSE 70 and 71 §).

Technical and commercial documents separated in YSE

When the general terms of agreement of Building Contract YSE in 1998 were reformed, one of the most significant reforms was directed to the document system of YSE. As distinct from earlier YSE 1983 conditions the contract documents were grouped to two groups, commercial (A) and to the technical (B) documents. Totally new documents also were added to the list of contract documents which in earlier YSE 1983 was not mentioned.

RunkoRYL 2000 Code of Good Building Practice of the Building Frame and External Envelope

RYL Code of Good Building Practice describes a generally accepted standard of the good construction practice. This edition is published as three books: MaaRYL 2000 (earthworks), RunkoRYL 2000 (building frame and external envelope), and SisäRYL 2000 (internal finishes). According to Talo 90 (Construction 90) Classification, RYLs contents deal with building elements and work sections. Chapters describing building elements serve as a support, guide and reminder for design as well as a table of contents for specification writing. Chapters devoted to work sections define requirements for building products and the performance of labour. RunkoRYL, dealing with the building frame and the external envelope for building construction, contains five building element chapters and twenty-nine work section chapters.

Structure of RunkoRYL 2000

RunkoRYL 2000 has been fitted in use one House to 90 nomenclature. RYL 2000 has been arranged to the structures and to the work specifications. The Structure division is suitable for the planning and the compilation of the master format. Building parts refer to the ones to be dealt with in the design the functional parts of the building. The building parts are for example a roof, a partition wall, a window installed to its place and a furniture group. The earthwork elements are e.g. surface structures, plantings and underdrains. The work element refers to the installation of a certain material and performance which is created from it. For example a wall which consists of the setting of bricks and seaming grout is named to be a work part. The work element include the material and the professional work. The work element division is therefore suitable for both building supplies and construction work to handle the quality.

Building element division

The first part of RunkoRYL processes building elements. The headlining of Building part division follows the Talo 90 nomenclature. The numbers of the Building elements are F1...F4. The Building element division have been analysed from the designer's point of view thus that the masterformat can be written according that order. RYL is a instruction to compile the masterformat. The model of the Masterformat is as an appendix of RYL. At the end of each Building part division is a typical structure type in which a designer check list is given.

The work section division

The demands of the work sections are presented in RunkoRYL's second part. The headlining of work section division follows the Talo 90 work section nomenclature order.

2.1.4 Master Format

The Master Format is drawn up by the main designer of the building project who usually is an architect. He supplements the masterformat by the work commentaries such as the element work, acoustic work, green work and painting work. They can be attached to the Master Format as appendix or separate documents. In the fixed appendix of the Master Format includes the Room Specifications. Parallel the documents of the Master Format are the HPAC commentary and the Electricity commentary. The master format is used during the process of the project when necessary by the other participants. The master format has a significant task because of its wide use in the data transfer inside the project. The well done Master Format brings the building partners closer because it determines the quality standard indisputedly. The building parts of Talo-nomenclature have been used already for decades as an analysis bottom of the master format. /19/

The House 90 nomenclature offers the project, building and equipment list for each one of them.

The division B can be the following :

- B1 General Information of the Building Project
- B2 The target and situation
- B3 The Owner
- B4 The User
- B5 The Designers

- F1 Foundations
- F2 Frame
- F3 Façade
- F4 ...

The House 90 – nomenclature doesn't any more include work as previous revisions. However, the building parts must be determined in the Master Formats. The identity number of the building type is used for the analysing the project-specific building components. Each building component is given its own ID- symbol e.g.:

- PO1, partitioning steel door EI60
- PO2, partitioning steel door EI120
- PO3, partitioning glass door E30.

See the Master Format Annex

The Documents of a Project

The project-specific documents can be divided to either judicial or technical documents .

Judicial documents regulates the business relationship between the subscriber and the supplier and technical documents describe the project. The project-specific documents are drafted separately for every project and the general documents are in use from one project to another.

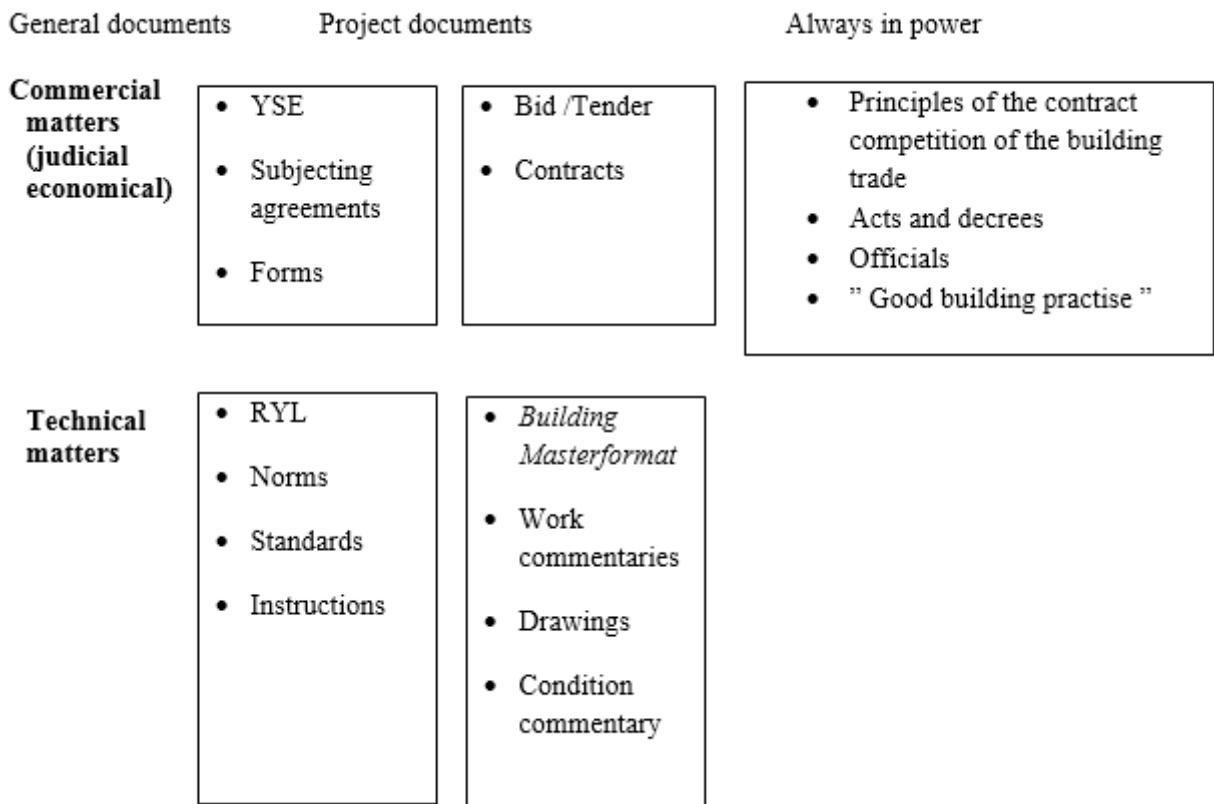

FIG 75 Structure of the documents of the building project and division (RT 16-10286 based).

2.2 Construction Management

Construction management or construction project management (CPM) is the overall planning, coordination, and control of a project from beginning to completion. CPM is aimed at meeting a client's requirement in order to produce a functionally and financially viable project.

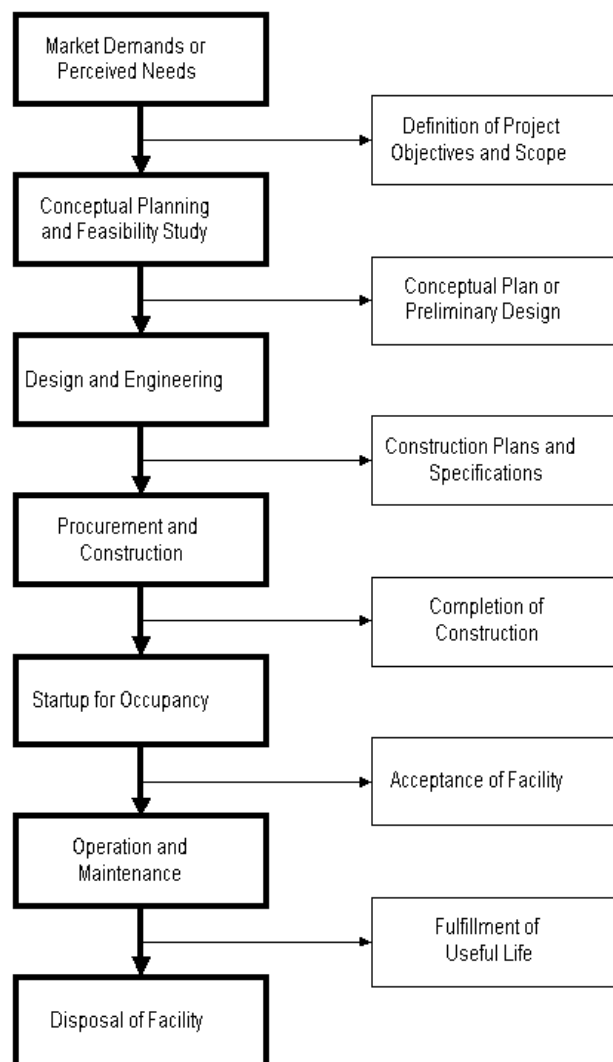

FIG 76 Project Life Cycle of a Constructed Facility /18/

2.2.1 Project stages

Feasibility Study and Design

The design stage contains a lot of steps: programming and feasibility, schematic design, design development and contract documents. It is the responsibility of the design team to ensure that the design meets all building codes and regulations. It is during the design stage that the bidding process takes place.

- **Programming and feasibility:** The needs, goals, and objectives must be determined for the building. Decisions must be made on the building size, number of rooms, how the space will be used, and who will be using the space. This must all be considered to begin the actual designing of the building.
- **Schematic design:** Schematic designs are sketches used to identify spaces, shapes, and patterns. Materials, sizes, colors, and textures must be considered in the sketches.
- **Design development:** This step requires research and investigation into what materials and equipment will be used as well as their cost.

- **Contract documents:** Contract documents are the final drawings and specifications of the construction project. They are used by contractors to determine their bid while builders use them for the construction process. Contract documents can also be called working drawings. /22/

Bid and Tendering

A bid is given to the owner by construction managers that are willing to complete their construction project. A bid tells the owner how much money they should expect to pay the construction management company in order for them to complete the project.

- **Open bid:** An open bid is used for public projects. Any and all contractors are allowed to submit their bid due to public advertising.
- **Closed bid:** A closed bid is used for private projects. A selection of contractors are sent an invitation for bid so only they can submit a bid for the specified project.

Selection methods

- **Low-bid selection:** This selection focuses on the price of a project. Multiple construction management companies submit a bid to the owner that is the lowest amount they are willing to do the job for. Then the owner usually chooses the company with the lowest bid to complete the job for them.
- **Best-value selection:** This selection focuses on both the price and qualifications of the contractors submitting bids. This means that the owner chooses the contractor with the best price and the best qualifications. The owner decides by using a request for proposal (RFP), which provides the owner with the contractor's exact form of scheduling and budgeting that the contractor expects to use for the project.
- **Qualifications-based selection:** This selection is used when the owner decides to choose the contractor only on the basis of their qualifications. The owner then uses a request for qualifications (RFQ), which provides the owner with the contractor's experience, management plans, project organization, and budget and schedule performance. The owner may also ask for safety records and individual credentials of their members. /22/

Pre-construction

The pre-construction stage begins when the owner gives a notice to proceed to the contractor that they have chosen through the bidding process. A notice to proceed is when the owner gives permission to the contractor to begin their work on the project. The first step is to assign the project team which includes the project manager (PM), contract administrator, superintendent and field engineer.

During the pre-construction stage, a site investigation must take place. A site investigation takes place to discover if any steps need to be implemented on the job site. This is in order to get the site ready before the actual construction begins. This also includes any unforeseen conditions such as historical artifacts or environment problems. A soil test must be done to determine if the soil is in good condition to be built upon. /22/

Procurement

The procurement stage is when labor, materials and equipment needed to complete the project are purchased. This can be done by the general contractor if the company does all their own construction work. If the contractor does not do their own work, they obtain it through subcontractors. Subcontractors are contractors who specialize in one particular aspect of the construction work such as concrete, welding, glass, or carpentry. Subcontractors are hired

the same way a general contractor would be, which is through the bidding process. Purchase orders are also part of the procurement stage.

- **Purchase orders:** A purchase order is used in various types of businesses. In this case, a purchase order is an agreement between a buyer and seller that the products purchased meet the required specifications for the agreed price. /22/

Construction

The construction stage begins with a pre-construction meeting brought together by the superintendent. The pre-construction meeting is meant to make decisions dealing with work hours, material storage, quality control, and site access. The next step is to move everything onto the construction site and set it all up.

At this stage, construction monitoring and supervision is of great importance to ensure that a project is completed on time and on budget, while meeting all relevant regulations and quality standards. /22/

Contractor progress payment schedule

A Contractor progress payment schedule is a schedule of when (according to project milestones or specified dates) contractors and suppliers will be paid for the current progress of installed work. Progress payments are partial payments for work completed during a portion, usually a month, during a construction period. Progress payments are made to general contractors, subcontractors, and suppliers as construction projects progress. Payments are typically made on a monthly basis but could be modified to meet certain milestones. Progress payments are an important part of contract administration for the contractor. Proper preparation of the information necessary for payment processing can help the contractor financially complete the project. /22/

Owner occupancy

Once the owner moves into the building, a warranty period begins. This is to ensure that all materials, equipment, and quality meet the expectations of the owner that are included within the contract. /22/

The Project Life Cycle

The project life cycle may be viewed as a process through which a project is implemented from cradle to grave. Owners must recognize that there is no single best approach in organizing project management throughout a project's life cycle. All organizational approaches have advantages and disadvantages, depending on the knowledge of the owner in construction management as well as the type, size and location of the project. It is important for the owner to be aware of the approach which is most appropriate and beneficial for a particular project. In making choices, owners should be concerned with the life cycle costs of constructed facilities rather than simply the initial construction costs. Saving small amounts of money during construction may not be worthwhile if the result is much larger operating costs or not meeting the functional requirements for the new facility satisfactorily. Thus, owners must be very concerned with the quality of the finished product as well as the cost of construction itself. Since facility operation and maintenance is a part of the project life cycle, the owners' expectation to satisfy investment objectives during the project life cycle will require consideration of the cost of operation and maintenance. Therefore, the facility's operating management should also be considered as early as possible, just as the construction process should be kept in mind at the early stages of planning and programming. /18/

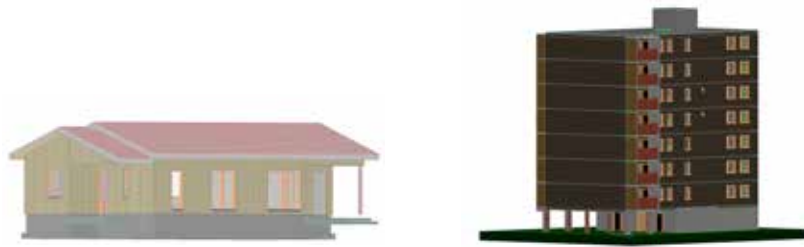

FIG 77 Residential houses

Residential Housing Construction

Residential housing construction includes single-family houses, multi-family dwellings, and high-rise apartments. During the development and construction of such projects, the developers or sponsors who are familiar with the construction industry usually serve as surrogate owners and take charge, making necessary contractual agreements for design and construction, and arranging the financing and sale of the completed structures. Residential housing designs are usually performed by architects and engineers, and the construction executed by builders who hire subcontractors for the structural, mechanical, electrical and other specialty work. An exception to this pattern is for single-family houses which may be designed by the builders as well. /18/

Institutional and Commercial Building Construction

Institutional and commercial building construction encompasses a great variety of project types and sizes, such as schools and universities, medical clinics and hospitals, recreational facilities and sports stadiums, retail chain stores and large shopping centers, warehouses and light manufacturing plants, and skyscrapers for offices and hotels. The owners of such buildings may or may not be familiar with construction industry practices, but they usually are able to select competent professional consultants and arrange the financing of the constructed facilities themselves. /18/

2.2.2 Organizing for Project Management

The management of construction projects requires knowledge of modern management as well as an understanding of the design and construction process. Construction projects have a specific set of objectives and constraints such as a required time frame for completion. Project management is the art of directing and coordinating human and material resources throughout the life of a project by using modern management techniques to achieve predetermined objectives of scope, cost, time, quality and participation satisfaction. The owner or facility sponsor holds the key to influence the construction costs of a project because any decision made at the beginning stage of a project life cycle has far greater influence than those made at later stages. /18/

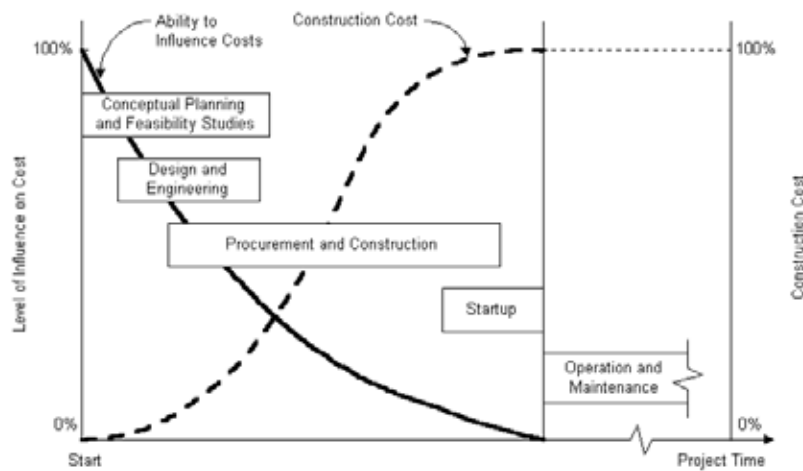

FIG 78 A Ability to Influence Construction Cost Over Time /18/

The uncertainty in undertaking a construction project comes from many sources and often involves many participants in the project. Since each participant tries to minimize its own risk, the conflicts among various participants can be detrimental to the project. Only the owner has the power to moderate such conflicts as it alone holds the key to risk assignment through proper contractual relations with other participants. Failure to recognize this responsibility by the owner often leads to undesirable results. /18/

The Design and Construction Process

In the planning of facilities, it is important to recognize the close relationship between design and construction. These processes can best be viewed as an integrated system. Broadly speaking, design is a process of creating the description of a new facility, usually represented by detailed plans and specifications; construction planning is a process of identifying activities and resources required to make the design a physical reality. Hence, construction is the implementation of a design envisioned by architects and engineers. In both design and construction, numerous operational tasks must be performed with a variety of precedence and other relationships among the different tasks. /18/

Constructor's Production Planning System

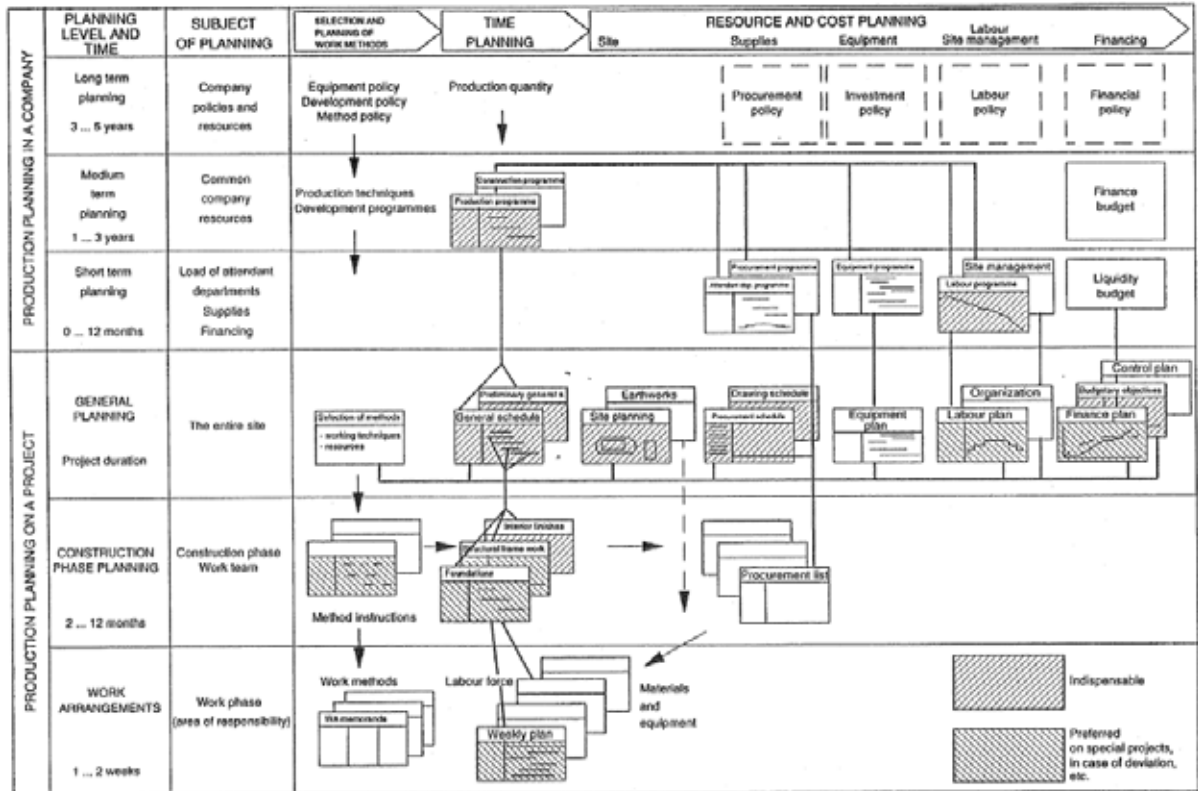

FIG 78 B Contractor's production planning system /23/

Production Planning on a construction project aims at most advantageous selection of working and resources as well as time activities. Projects and activities are planned so that an individual project can be completed according to plans and contracts. /2/

The development of a construction plan is very much analogous to the development of a good facility design. The planner must weigh the costs and reliability of different options while at the same time insuring technical feasibility. Construction planning is more difficult in some ways since the building process is dynamic as the site and the physical facility change over time as construction proceeds. On the other hand, construction operations tend to be fairly standard from one project to another, whereas structural or foundation details might differ considerably from one facility to another. From the standpoint of **construction contractors** or the construction divisions of large firms, the planning process for construction projects consists of three stages that take place between the moment in which a planner starts the plan for the construction of a facility to the moment in which the evaluation of the final output of the construction process is finished.

The estimate stage involves the development of a cost and duration estimate for the construction of a facility as part of the proposal of a contractor to an owner. It is the stage in which assumptions of resource commitment to the necessary activities to build the facility are made by a planner. The result of a high estimate would be to lose the job, and the result of a low estimate could be to win the job, but to lose money in the construction process. When changes are done, they should improve the estimate, taking into account not only present effects, but also future outcomes of succeeding activities. It is very seldom the case in which the output of the construction process exactly echoes the estimate offered to the owner.

In the **monitoring and control stage** of the construction process, the construction manager has to keep constant track of both activities' durations and ongoing costs. Constant evaluation is necessary until the construction of the facility is complete. When work is finished in the construction process, and information about it is provided to the planner, the third stage of the planning process can begin.

The evaluation stage is the one in which results of the construction process are matched against the estimate. A planner deals with this uncertainty during the estimate stage. Only when the outcome of the construction process is known is he/she able to evaluate the validity of the estimate. It is in this last stage of the planning process that he or she determines if the assumptions were correct. If they were not or if new constraints emerge, he/she should introduce corresponding adjustments in future planning. /18/

Company level production planning can be divided into three parts on the basis of time spent planning:

- Formulating company policy
- Activity planning for the following 1...3 accounting periods
- Production planning for the on-going accounting period

Company level production planning is aimed at, for instance, advantageous choices of financial, production and personnel policies and the efficient allocation of resources to various projects. /2/

The objective of the production planning on a construction project is advantageous completion of the project within the established time limits according to the plans, contracts, regulations and work quality objectives.

The accuracy of timing of the planning activities divide the production planning in a building construction into four categories:

- Preliminary production planning in the tender phase
- General planning, before construction commences
- Production planning in phases during construction
- Weekly planning during construction

According to the content of the plan, production planning on a construction can be divided into

- time planning, e.g. interior work phase schedule and preparation of the resource plan that is connected with it
- economic and financial planning e.g. preparation of the budgetary objectives
- general production planning e.g. preparation of the site plan /23/

Production planning is a fundamental and challenging activity in the management and execution of construction projects. It involves the choice of technology, the definition of work tasks, the estimation of the required resources and durations for individual tasks, and the identification of any interactions among the different work tasks. A good construction plan is the basis for developing the budget and the schedule for work. Developing the production plan is a critical task in the management of construction, even if the plan is not written or otherwise formally recorded. In addition to these technical aspects of construction planning, it may also be necessary to make organizational decisions about the relationships between project participants and even which organizations to include in a project. For example, the extent to which sub-contractors will be used on a project is often determined during construction planning /18/

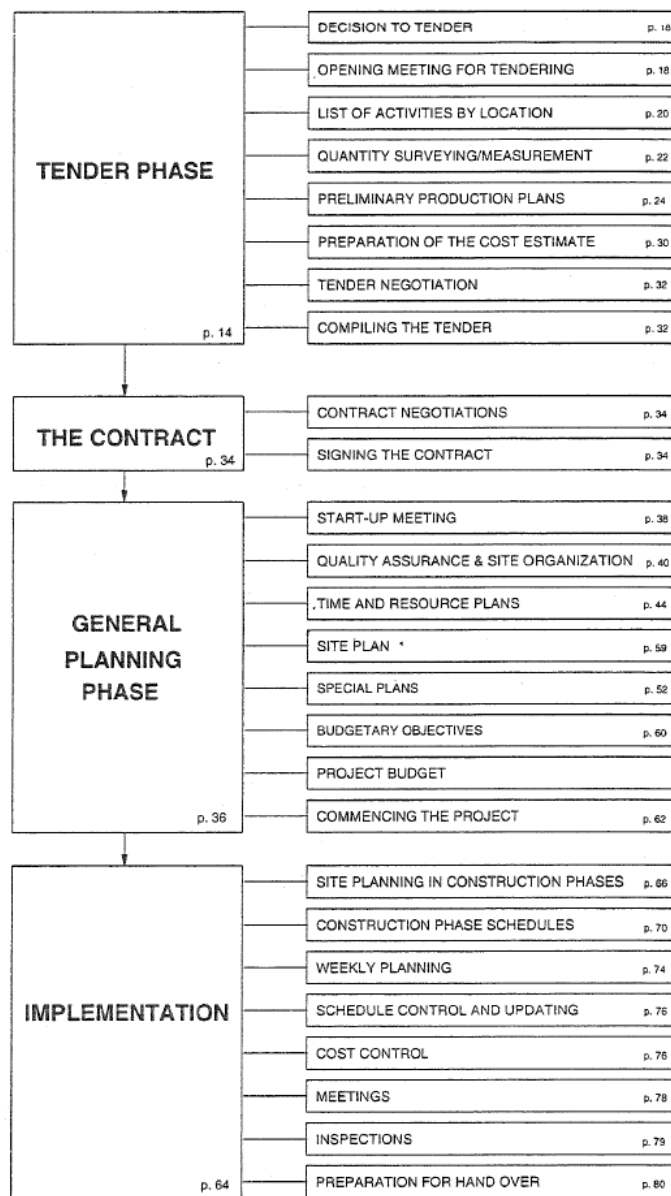

FIG 78 C Main phases in production planning /23/

Labor, Material and Equipment Utilization

Good project management in construction must vigorously pursue the efficient utilization of labor, material and equipment. Improvement of labor productivity should be a major and continual concern of those who are responsible for cost control of constructed facilities. Material handling, which includes procurement, inventory, shop fabrication and field servicing, requires special attention for cost reduction. The use of new equipment and innovative methods has made possible wholesale changes in construction technologies in recent decades. Organizations which do not recognize the impact of various innovations and have not adapted to changing environments have justifiably been forced out of the mainstream of construction activities. /18/

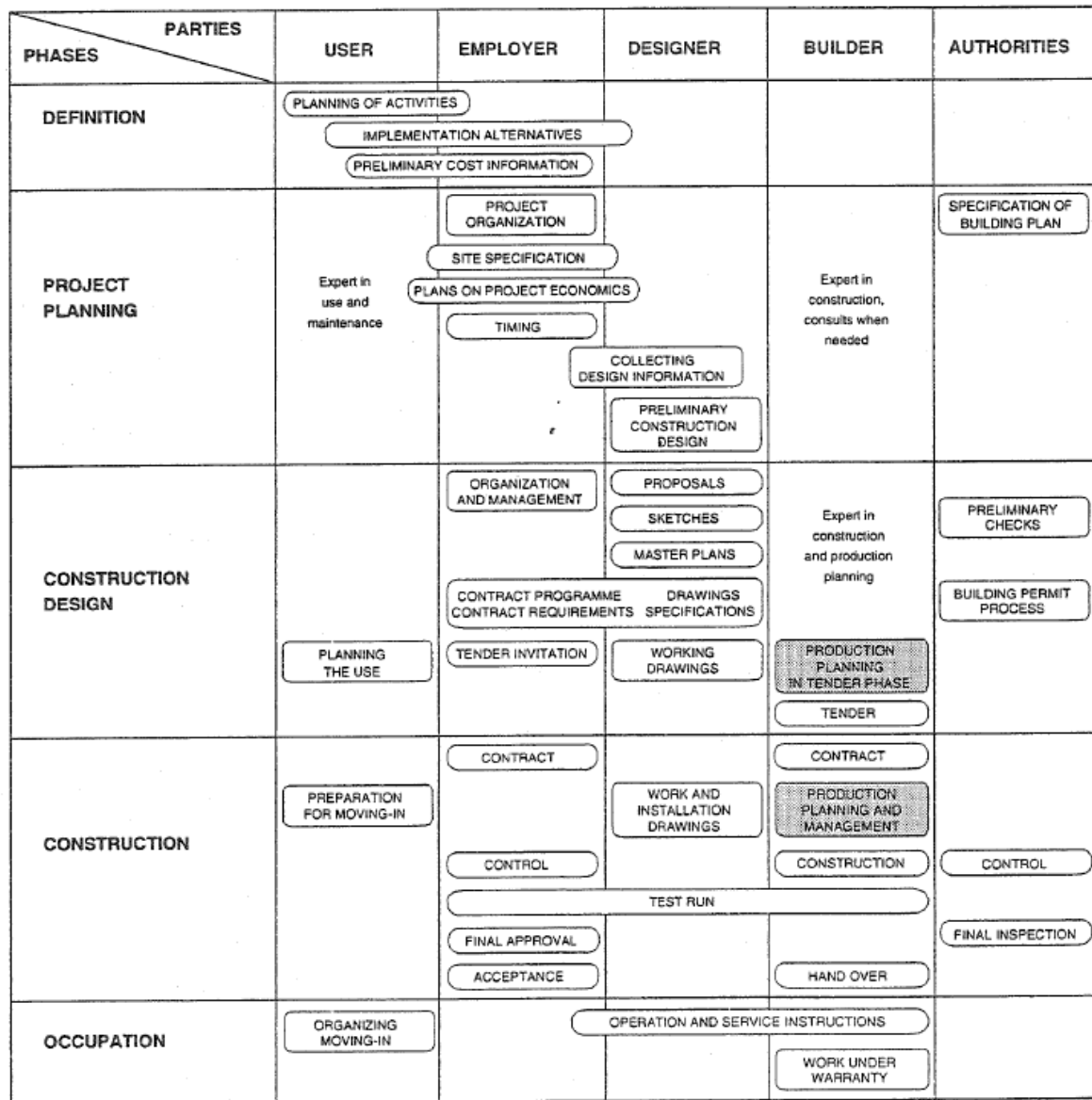

FIG 79 Parties and phases in a construction process /23/

2.2.3 Cost Estimation

Virtually all cost estimation is performed according to one or some combination of the following basic approaches: Empirical cost inference, Unit costs for bill of quantities or Allocation of joint costs. Empirical estimation of cost functions requires statistical techniques which relate the cost of constructing or operating a facility to a few important characteristics or attributes of the system. A unit cost is assigned to each of the facility components or tasks as represented by the bill of quantities. The total cost is the summation of the products of the quantities multiplied by the corresponding unit costs. Allocations of cost from existing accounts may be used to develop a cost function of an operation. The basic idea in this method is that each expenditure item can be assigned to particular characteristics of the operation. /3/

Construction cost estimates may be viewed from different perspectives because of different institutional requirements. In spite of the many **types of cost estimates** used at different stages of a project, cost estimates can best be classified into three major categories according to their functions. A construction cost estimate serves one of the three basic functions: design, bid and control. For establishing the financing of a project, either a design estimate or a bid estimate is used. /18/

Coding Systems

One objective in many construction planning efforts is to define the plan within the constraints of a universal *coding system* for identifying activities. Each activity defined for a project would be identified by a pre-defined code specific to that activity. The use of a common nomenclature or identification system is basically motivated by the desire for better integration of organizational efforts and improved information flow. In particular, coding systems are adopted to provide a numbering system to replace verbal descriptions of items. These codes reduce the length or complexity of the information to be recorded. A common coding system within an organization also aids consistency in definitions and categories between projects and among the various parties involved in a project. Common coding systems also aid in the retrieval of historical records of cost, productivity and duration on particular activities. Finally, electronic data storage and retrieval operations are much more efficient with standard coding systems..

In North America, the most widely used standard coding system for constructed facilities is the MASTERFORMAT system developed by the Construction Specifications Institute (CSI) of the United States and Construction Specifications of Canada. After development of separate systems, this combined system was originally introduced as the Uniform Construction Index (UCI) in 1972 and was subsequently adopted for use by numerous firms, information providers, professional societies and trade organizations. The term MASTERFORMAT was introduced with the 1978 revision of the UCI codes. MASTERFORMAT provides a standard identification code for nearly all the elements associated with building construction.

MASTERFORMAT involves a hierarchical coding system with multiple levels plus keyword text descriptions of each item. In the numerical coding system, the first two digits represent one of the sixteen divisions for work; a seventeenth division is used to code conditions of the contract for a constructor. In the latest version of the MASTERFORMAT, a third digit is added to indicate a subdivision within each division. Each division is further specified by a three digit extension indicating another level of subdivisions. /18/

0 Conditions of the contract	9 Finishes
1 General requirements	10 Specialties
2 Site work	11 Equipment
3 Concrete	12 Furnishings
4 Masonry	13 Special construction
5 Metals	14 Conveying system
6 Wood and plastics	15 Mechanical
7 Thermal and moisture prevention	16 Electrical
8 Doors and windows	

/18/

2.2.4 Fundamental Scheduling Procedures

In addition to assigning dates to project activities, project scheduling is intended to match the resources of equipment, materials and labor with project work tasks over time. Good scheduling can eliminate problems due to production bottlenecks, facilitate the timely procurement of necessary materials, and otherwise insure the completion of a project as soon as possible. In contrast, poor scheduling can result in considerable waste as laborers and equipment wait for the availability of needed resources or the completion of preceding tasks. Delays in the completion of an entire project due to poor scheduling can also create havoc for owners who are eager to start using the constructed facilities.

2.2.5 Cost Control, Monitoring and Accounting

During the execution of a project, procedures for project control and record keeping become indispensable tools to managers and other participants in the construction process. These tools serve the dual purpose of recording the financial transactions that occur as well as giving managers an indication of the progress and problems associated with a project.

2.2.6 Quality Control and Safety During Construction

Quality control and safety represent increasingly important concerns for project managers. Defects or failures in constructed facilities can result in very large costs. Even with minor defects, re-construction may be required and facility operations impaired. Increased costs and delays are the result. In the worst case, failures may cause personal injuries or fatalities. Accidents during the construction process can similarly result in personal injuries and large costs. Indirect costs of insurance, inspection and regulation are increasing rapidly due to these increased direct costs. Good project managers try to ensure that the job is done right the first time and that no major accidents occur on the project.

As with cost control, the most important decisions regarding the quality of a completed facility are made during the design and planning stages rather than during construction. It is during these preliminary stages that component configurations, material specifications and functional performance are decided. Quality control during construction consists largely of insuring conformance to these original design and planning decisions.

3 The National Building Code of Finland

/3/

3.1 Introduction

The National Building Code contains technical regulations and instructions, which are given by decree. The regulations are binding and concern the construction of new buildings. The regulations are applicable to renovation and alteration works only insofar as the type and extent of the measure and a possible change in use of the building require. The instructions are not binding but present acceptable solutions.

- A General section
- B The strength of structures
- C Insulation
- D Hepac and energy management
- E Structural fire safety
- F General building planning
- G Housing planning and building

3.1.1 A General section

A1 Supervision of construction work
Regulations and guidelines

A2 Building designers and plans (unofficial translation)
Regulations and guidelines 2002

A4 Maintenance manual for the care and use of buildings
Regulations and guidelines

A5 Plan notations
Regulations

3.1.2 B The strength of structures

B1 Structural safety and loads
Regulations

B2 Loadbearing structures
Regulations

B3 Foundations (unofficial translation)
Regulations and guidelines 2004

B4 Concrete structures
Guidelines

B5 Structures of lightweight concrete blocks
Guidelines

B6 Light gauge steel structures
Guidelines

B7 Steel structures
Guidelines

B8 Brick structures
Guidelines

B9 Structures of concrete blocks
Guidelines

B10 Timber structures
Guidelines

C Insulation

C1 Sound insulation and noise abatement in building
Regulations and guidelines

C2 Moisture
Regulations and guidelines

C3 Thermal insulation in a building (unofficial translation)
Regulations 2003

C4 Thermal insulation (unofficial translation)
Guidelines 2003

3.1.3 D Hepac and energy management

D1 Water supply and drainage installations for buildings
Regulations and guidelines

D2 Indoor climate and ventilation of buildings (unofficial translation)
Regulations and guidelines

D3 Energy management in buildings
Regulations and guidelines

D4 HEPAC drawings
Regulations

D5 Calculation of power and energy needs for
heating of buildings
Guidelines

D7 Efficiency requirements for boilers
Regulations

3.1.4 E Structural fire safety

E1 Structural fire safety in buildings (unofficial translation)
Regulations and guidelines 2002

E2 Fire safety of production and warehouse buildings (unofficial translation)
Guidelines 2005

E3 Small chimneys
Guidelines

E4 Fire safety of garages (unofficial translation)
Guidelines 2005

E7 Fire safety of ventilation installations (unofficial translation)
Guidelines 2004

E8 Masonry fireplaces
Guidelines

E9 Fire safety of boiler rooms and fuel stores (unofficial translation)
Guidelines 2005

3.1.5 F General building planning

F1 Barrier-free building (unofficial translation)
Regulations and guidelines 2005

F2 Safety in use buildings
Regulations and guidelines

3.1.6 G Housing planning and building

G1 Housing design (unofficial translation)
Regulations and guidelines 2005

G2 Subsidized housing
Regulations and guidelines

Eurocodes

Ministry of the Environment Decree on applying Eurocode standards in building construction
(unofficial translation)

A2 NATIONAL BUILDING CODE OF FINLAND

/3/

Ministry of the Environment

Housing and Building Department

**BUILDING DESIGNERS AND PLANS
REGULATIONS AND GUIDELINES 2002**

The A2 Content is as follows:

1 OBJECTIVES AND SCOPE OF APPLICATION

2 DUTY OF CARE BY THE PARTY ENGAGING IN A BUILDING PROJECT

3 DESIGNERS' DUTIES

3.1 Principal designer's duties and responsibility for the design in its entirety

3.2 Designers' duties

4 DESIGNERS' QUALIFICATIONS

4.1 Assessment of a designer's qualifications

4.2 The degree of difficulty of the design task and the designers' proficiency

5 PERMIT DOCUMENTS AND OTHER PLANS AND REPORTS/DETAILS

5.1 General

5.2 Master drawings

5.3 Details to be enclosed with permit applications

5.4 Special designs and reports

The objective of building guidance is to promote the creation of a good living environment that is socially functional and aesthetically harmonious, safe and pleasant and serves the needs of its users. The Building bases on approaches which have sustainable and economical life-cycle properties and are socially and economically viable, and create and maintain cultural values. In addition the planned and continuous care and maintenance of the built environment and building stock is promoted.

A party engaging in a building project shall ensure that the building is designed and constructed in accordance with building provisions and regulations and the permit granted. The party shall have the necessary competence to implement the project, as required by its difficulty, and access to qualified personnel.

A design shall be prepared for construction that meets the requirements of the Act and provisions and regulations issued under it, and the requirements of good building practice. A qualified person shall be in charge of the design in its entirety and of its quality, ensuring that the building design and any special designs form a complete entity which meets the requirements set for it (principal designer).

The person drawing up a building or special design must have the training and expertise required by the type of building project concerned and the demands of the duties involved. The qualifications required in designing are judged according to the intended use of the building and the spaces within it, the structural loads and fire loads, the design, calculation and dimensioning methods, environmental requirements and in addition to the above any unconventional aspects of the design approach.

Design and management duties can be classified in requirement classes in order to specify the minimum qualifications. The minimum qualifications shall be prescribed by decree, and more detailed regulations and guidelines will be issued in the National Building Code of Finland.

Persons drawing up a building design or special design shall have a construction-related university degree appropriate for the planning functions in question, or an earlier construction-related higher-level vocational or other degree, and sufficient experience of working on the type of planning in question.

Buildings that are small or have ordinary technical properties may also be designed by persons with a college-level qualification in construction or in the relevant line of special study, or a corresponding earlier qualification if they are sufficiently experienced.

In addition, a person who does not possess one of the aforementioned qualifications but is deemed to have the skill required in view of the type and extent of the construction work or design task, may also carry out minor design works.

The master drawings to be followed in construction are approved in connection with the grant of a building permit. The building inspector may grant approval for deviation from the approved design during the course of construction unless the nature of the deviation and the provisions and regulations on permit consideration require substantial amendment of the plan and the deviation affects the interests of neighbours.

Any amendments approved during the course of construction and the approving official shall be indicated on the drawings. Inspected drawings shall be submitted to the local building supervision authority before the final review. The master drawings enclosed with a building permit application comprise a site plan and floor plan, section and elevation drawings.

The ground investigation report on the building site and, if needed, an account of the site's health effects and ground levels, and the type of foundation and any other measures required as a result shall be enclosed with the building permit application.

Permit applications and notifications concerning the construction or demolition of a building or part of a building shall include an account of the amount and type of construction waste and how it will be sorted, unless the amount of waste is minor. Applications and notifications shall report separately any construction and demolition waste that is harmful to health or the environment, and how it will be disposed of.

Regulations on preparing special designs and submitting them to the local building supervision authority may be included in the building permit.

Any need to provide the local building supervision authority with special designs and reports is stated in the building permit, at the start-up meeting or, if special cause exists, during the construction work. This is not necessary if the building in question is smallish with basic structural and technical attributes.

3.2 Loads

The loads are determined according to the standard SFS-EN 1991-1-x and its national Annexes.

Dead Load

Check SFS-EN 1991-1-x and its national Annexes. The dead load of e.g. concrete is 25 kN/m³ and the dry solid timber and the glue lam is 5 kN/m³.

The Imposed Loads

TABLE

Table 6.1 Categories of use

Category	Specific Use	Example
A	Areas for domestic and residential activities	Rooms in residential buildings and houses; bedrooms and wards in hospitals; bedrooms in hotels and hostels kitchens and toilets.
B	Office areas	
C	Areas where people may congregate (with the exception of areas defined under category A, B, and D ¹⁾)	<p>C1: Areas with tables, etc. e.g. areas in schools, cafés, restaurants, dining halls, reading rooms, receptions.</p> <p>C2: Areas with fixed seats, e.g. areas in churches, theatres or cinemas, conference rooms, lecture halls, assembly halls, waiting rooms, railway waiting rooms.</p> <p>C3: Areas without obstacles for moving people, e.g. areas in museums, exhibition rooms, etc. and access areas in public and administration buildings, hotels, hospitals, railway station forecourts.</p> <p>C4: Areas with possible physical activities, e.g. dance halls, gymnastic rooms, stages.</p> <p>C5: Areas susceptible to large crowds, e.g. in buildings for public events like concert halls, sports halls including stands, terraces and access areas and railway platforms.</p>
D	Shopping areas	D1: Areas in general retail shops D2: Areas in department stores
<p>¹⁾ Attention is drawn to 6.3.1.1(2), in particular for C4 and C5. See EN 1990 when dynamic effects need to be considered. For Category E, see Table 6.3</p> <p>NOTE 1 Depending on their anticipated uses, areas likely to be categorised as C2, C3, C4 may be categorised as C5 by decision of the client and/or National annex.</p> <p>NOTE 2 The National annex may provide sub categories to A, B, C1 to C5, D1 and D2</p> <p>NOTE 3 See 6.3.2 for storage or industrial activity</p>		

6.3.1.2 Values of actions

(1)P The categories of loaded areas, as specified in Table 6.1, shall be designed by using characteristic values q_k (uniformly distributed load) and Q_k (concentrated load)

NOTE: Values for q_k and Q_k are given in Table 6.2 below. Where a range is given in this table, the value may be set by the National annex. The recommended values, intended for separate application, are underlined. q_k is intended for determination of general effects and Q_k for local effects. The National annex may define different conditions of use of this Table.

Table 6.2 Imposed loads on floors, balconies and stairs in buildings

Categories of loaded areas	q_k [kN/m ²]	Q_k [kN]
Category A		
— Floors	1,5 to <u>2,0</u>	<u>2,0</u> to 3,0
— Stairs	<u>2,0</u> to 4,0	<u>2,0</u> to 4,0
— Balconies	<u>2,5</u> to 4,0	<u>2,0</u> to 3,0
Category B	2,0 to <u>3,0</u>	1,5 to <u>4,5</u>
Category C		
— C1	2,0 to <u>3,0</u>	3,0 to <u>4,0</u>
— C2	3,0 to <u>4,0</u>	2,5 to 7,0 (<u>4,0</u>)
— C3	3,0 to <u>5,0</u>	<u>4,0</u> to 7,0
— C4	4,5 to <u>5,0</u>	3,5 to <u>7,0</u>
— C5	<u>5,0</u> to 7,5	3,5 to <u>4,5</u>
category D		
— D1	4,0 to 5,0	3,5 to 7,0 (<u>4,0</u>)
— D2	1,5 to 2,0	3,5 to <u>7,0</u>

Snow load by the Simple Instructions

The characteristic values of the snow load on the ground s_k is presented on the picture 2.1. The load on the roofs q_k is determined by the snow load on the ground with the factor μ_i $q_k = \mu_i s_k$

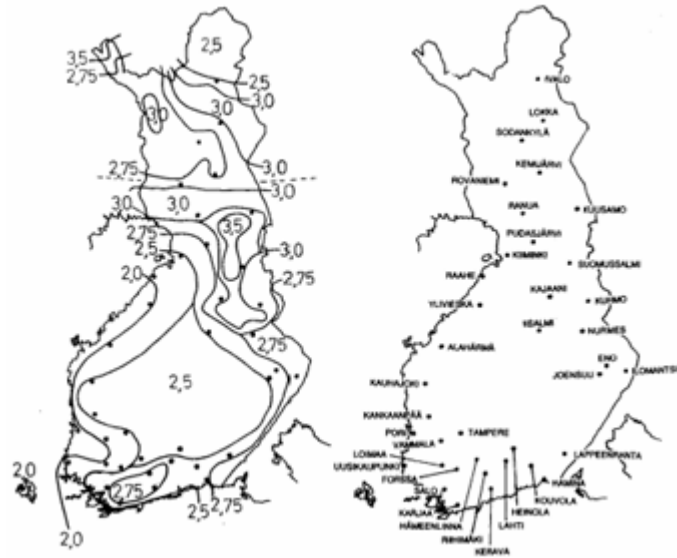

FIG 80 Snow load on the ground

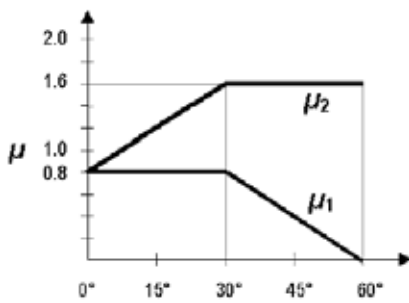

Figure 5.1 Snow load shape coefficients

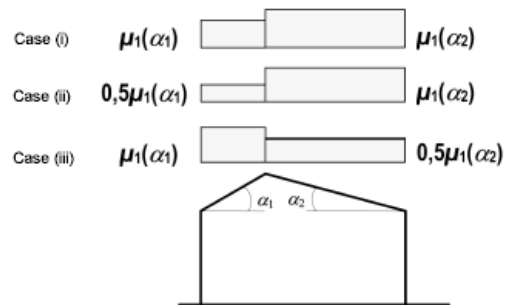

Figure 5.3 Snow load shape coefficients – pitched roofs

FIG 81 Snow load coefficients

The Wind Load

The next presentation is a simplified way to determine the wind load with typical buildings.

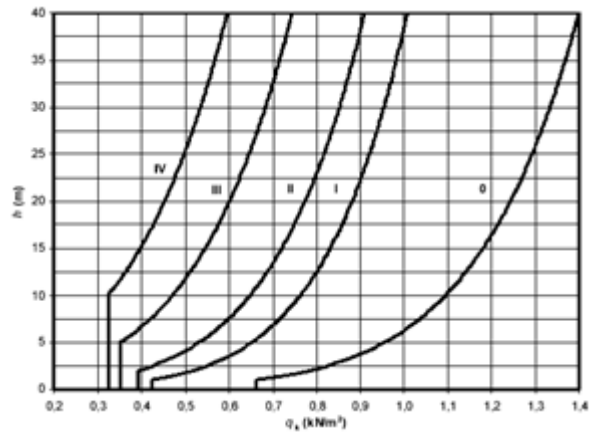

FIG 82 Characteristic values of the velocity pressure

The vertical total wind force by the Simple Instructions

$$F_{w,k} = c_f q_k(h) A_{ref}$$

where

c_f is the external pressure coefficient $c_f = 1.3$ usually

$q_k(h)$ is the velocity pressure according to the height of the building

A_{ref} is the perpendicular projection area against the wind

The resultant of the total wind force is supposed to effect on the level $0,6 h$ from the ground

Extracts from Builder's Foundation Handbook /20/

Introduction to Foundation Design

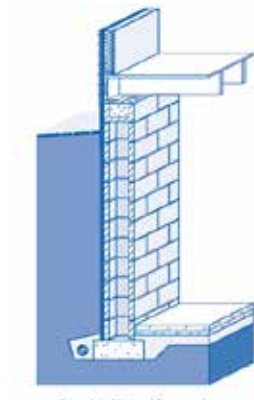

FIG 83 Basement Foundation /20/

The foundation of a house is a somewhat invisible and sometimes ignored component of the building. It is increasingly evident, however, that attention to good foundation design and construction has significant benefits to the homeowner and the builder, and can avoid some serious future problems. Good foundation design and construction practice means not only insulating to save energy, but also providing effective structural design as well as moisture, termite, and radon control techniques where appropriate.

Foundation Design

The primary reason behind the current interest in foundation design and construction is related to energy conservation, although in some areas radon control is also a primary concern.

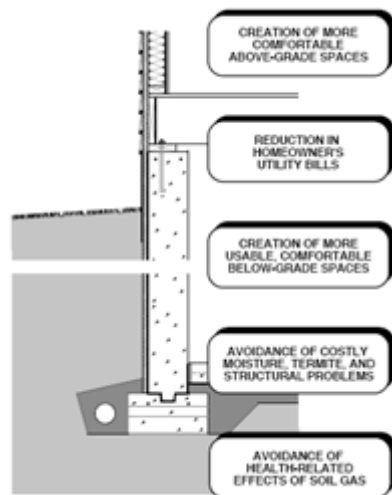

FIG 84 Benefits of Foundation Insulation /20/

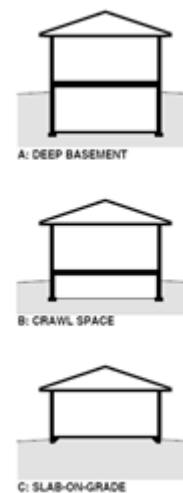

FIG 85 Foundation types /20/

The three basic types of foundations – full basement, crawlspace, and slab-on-grade – are shown in Figure. Of course, actual houses may include combinations of these types. Information on a fourth type of foundation – the shallow or half-bermed basement – can be found in the Building Foundation Design Handbook (Labs et al. 1988). There are several construction systems from which to choose for each foundation type. The most common systems, cast-inplace concrete and concrete block foundation walls, can be used for all four basic foundation types.

A slab-on-grade construction with an integral concrete grade beam at the slab edge is common in climates with a shallow frost depth. In colder climates, deeper cast-in-place concrete walls and concrete block walls are more common, although a shallower footing can sometimes be used depending on soil type, groundwater conditions, and insulation placement. Most of the foundation types and construction systems described above can be designed to meet necessary structural, thermal, radon, termite and moisture or water control requirements. Factors affecting the choice of foundation type and construction system include site conditions, overall building design, the climate, and local market preferences as well as construction costs. These factors are discussed below. /20/

Site Conditions

The topography, water table location, presence of radon, soil type, and depth of bedrock can all affect the choice of a foundation type. Any foundation type can be used on a flat site; however, a sloping site often necessitates the use of a walkout basement or crawl space. On steeper slopes, a walkout basement combines a basement foundation wall on the uphill side, a slab-on-grade foundation on the downhill side, and partially bermed foundation walls on the remaining two sides.

A water table depth within 8 feet of the surface will likely make a basement foundation undesirable. Lowering the water table with drainage and pumping usually cannot be justified, and waterproofing may not be feasible or may be too costly. A water table near the surface generally restricts the design to a slab-on-grade or crawl space foundation.

The presence of expansive clay soils on a site requires special techniques to avoid foundation movement and significant structural damage. Often, buildings placed on sites with expansive clay require pile foundations extending down to stable soil strata or bedrock. Similarly, sites with bedrock near the surface require special foundation techniques. Expensive bedrock excavation is not required to reach frost depth nor is it economically justifiable to create basement space. In these unusual conditions of expansive clay soils or bedrock near the surface, special variations of the typical foundation types may be appropriate. /20/

Overall Building Design

The foundation type and construction system are chosen in part because of appearance factors. Although it is not usually a major aesthetic element, the foundation at the base of a building can be raised above the ground plane, so the foundation wall materials can affect the overall appearance. A building with a slab on-grade foundation has little visible foundation; however, the foundation wall of a crawl space or basement can vary considerably from almost no exposure to full exposure above grade. /20/

Climate

The preference of foundation type varies with climatic region, although examples of most types can generally be found in any given region. One of the principal factors behind foundation preference is the impact of frost depth on foundation design. The Builder's Foundation Handbook Page 7 impact of frost depth basically arises from the need to place foundations at greater depths in colder climates. For example, a footing in Minnesota must be at least 42 inches below the surface, while in states along the Gulf Coast, footings need not extend below the surface at all in order to avoid structural damage from frost heave. /20/

Radon Mitigation Techniques

In this introductory chapter radon is addressed because it is a relatively new concern and one in which techniques to deal with it are just emerging. Radon is a colorless, odorless, tasteless

gas found in soils and underground water. An element with an atomic weight of 222, radon is produced in the natural decay of radium, and exists at varying levels. Radon is emitted from the ground to the outdoor air, where it is diluted to an insignificant level by the atmosphere. Because radon is a gas, it can travel through the soil and into a building through cracks, joints, and other openings in the foundation floor and wall. Earth-based building materials such as cast concrete, concrete masonry, brick, and adobe ordinarily are not significant sources of indoor radon. Radon from well water sometimes contributes in a minor way to radon levels in indoor air. In a few cases, radon from well water has contributed significantly to elevated radon levels. Radon is potentially harmful only if it is in the lungs when it decays into other isotopes (called radon progeny or radon daughters), and when these further decay. The decay process releases small amounts of ionizing radiation; this radiation is held responsible for the above-normal incidence of lung cancer found among miners. Most of what is known about the risk of radon exposure is based on statistical analysis of lung cancers in humans (specifically, underground miners) associated with exposure to radon. This information is well documented internationally, although much less is known about the risk of long-term.

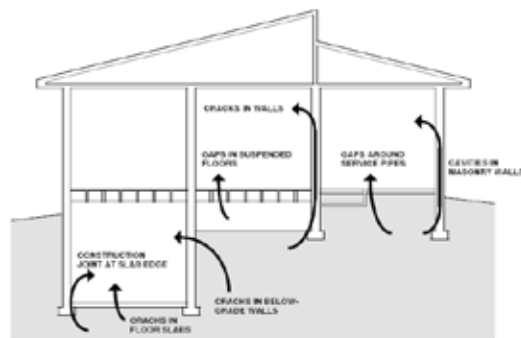

Figure 1-6 Points of Radon Entry into Buildings

FIG 86 Radon entry points /20/

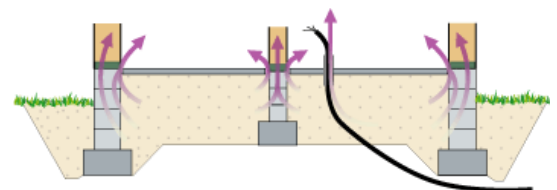

FIG 87 Radon entry points /4/

Strategies to Control Radon

In order to address the radon problem, it is necessary to find out to what degree it is present on the site. Then, depending on the level of concern, various techniques to control radon levels can be applied. Generally there are three approaches: (1) the barrier approach, (2) soil gas interception, and (3) indoor air management. The barrier approach refers to a set of techniques for constructing a tight building foundation in order to prevent soil gas from entering. /20/

Basement Construction

The term deep basement refers to a 7- to 10-foot basement wall with no more than the upper 25 percent exposed above grade.

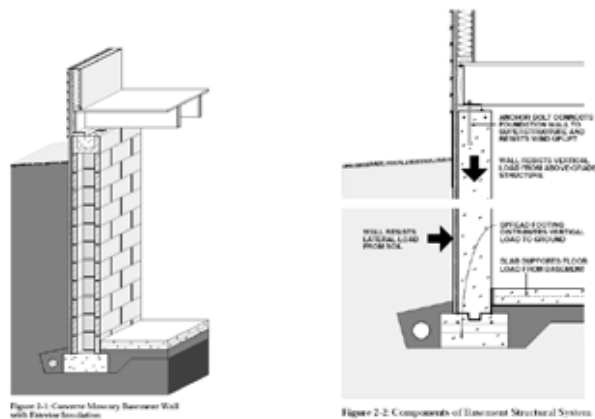

FIG 88 Concrete Masonry Basement Wall /20/

The major structural components of a basement are the wall, the footing, and the floor. Basement walls are typically constructed of cast-in-place concrete or concrete masonry units .

Basement walls must be designed to resist lateral loads from the soil and vertical loads from the structure above. The lateral loads on the wall depend on the height of the fill, the soil type, soil moisture content, and whether the building is located in an area of low or high seismic activity. Some simple guidelines for wall thickness, concrete strength, and reinforcing are given in the construction details. Where simple limits are exceeded, a structural engineer should be consulted. Concrete spread footings provide support beneath basement concrete and masonry walls and columns. Footings must be designed with adequate size to distribute the load to the soil. Unless founded on bedrock or proven non-frost-susceptible soils, footings must be placed beneath the maximum frost penetration depth or be insulated to prevent frost penetration.

Concrete slab-on-grade floors are generally designed to have sufficient strength to support floor loads without reinforcing when poured on undisturbed or compacted soil. The use of welded wire fabric and concrete with a low water/cement ratio can reduce shrinkage cracking, which is an important concern for appearance and for reducing potential radon infiltration engineer is recommended. /20/

Drainage and waterproofing

Keeping water out of basements is a major concern in many regions. The source of water is primarily from rainfall, snow melt, and sometimes irrigation on the surface. In some cases, the groundwater table is near or above the basement floor level at times during the year. There are three basic lines of defense against water problems in basements: (1) surface drainage, (2) subsurface drainage, and (3) dampproofing or waterproofing on the wall surface . /20/

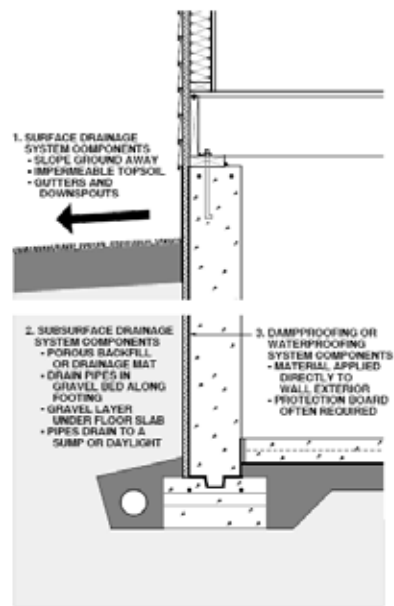

Figure 2-3: Components of Basement Drainage and Waterproofing Systems

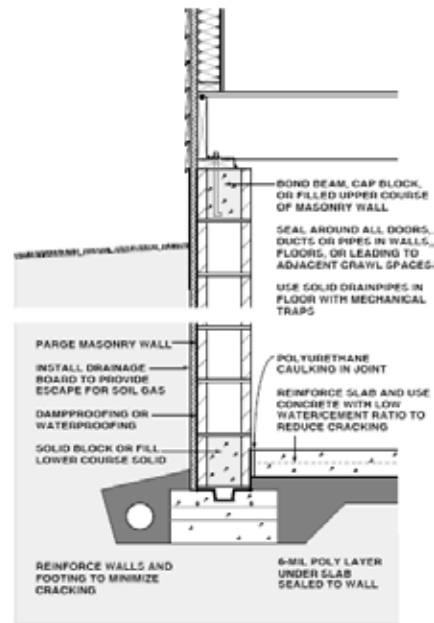

Figure 2-5: Radon Control Techniques for Basements

FIG 89 Components of Basement Drainage and Waterproofing Systems /20/

Insulation

A key question in foundation design is whether to place insulation inside or outside the basement wall. In terms of energy use, there is not a significant difference between the same amount of full wall insulation applied to the exterior versus the interior of a concrete or masonry wall. However, the installation costs, ease of application, appearance, and various technical concerns can be quite different. Individual design considerations as well as local costs and practices determine the best approach for each project. /20/

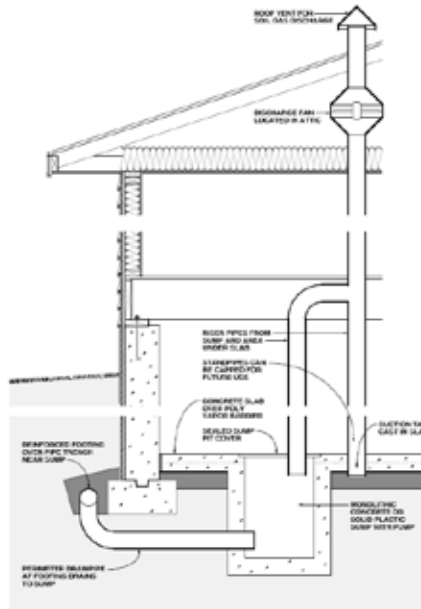

Figure 2-9: Soil Gas Collection and Discharge Techniques

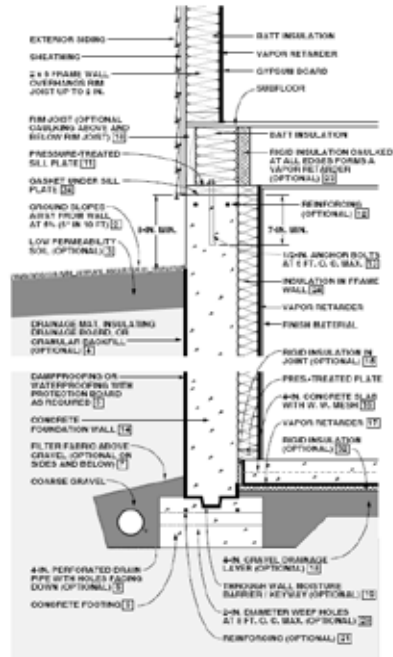

Figure 2-11: Concrete Basement Wall with Interior Insulation

FIG 90 Foundation details /20/

Crawl Space Construction

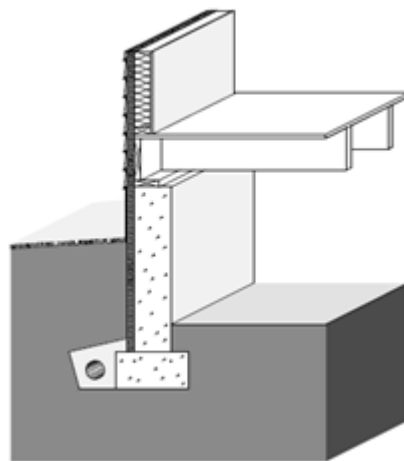

FIG 91 Concrete Crawl Space Wall /20/

The principal perceived advantage of a vented crawl space over an unvented one is that venting can minimize radon and moisture-related decay hazards by diluting the crawl space air. Venting can complement other moisture and radon control measures such as ground cover and proper drainage. However, although increased air flow in the crawl space may offer some dilution potential for ground source moisture and radon, it will not necessarily solve a serious problem. The principal disadvantages of a vented crawl space over an unvented one are that (1) pipes and ducts must be insulated against heat loss and freezing, (2) a larger area usually must

be insulated, which may increase the cost, and (3) in some climates warm humid air circulated into the cool crawl space can actually cause excessive moisture levels in wood. Vented crawl spaces are often provided with operable vents that can be closed to reduce winter heat losses, but also potentially increase radon infiltration.

The major structural components of a crawl space are the wall and the footing. Crawl space walls are typically constructed of cast-in-place concrete, concrete masonry units, or pressure-treated wood.

Although a crawl space foundation is not as deep as a full basement, it is highly desirable to keep it dry. Good surface drainage is always recommended and, in many cases, subsurface drainage systems may be desirable.

If a vented crawl space is insulated, the insulation is always located in the ceiling. Most commonly, batt insulation is placed between the floor joists. The depth of these joist spaces accommodates high insulation levels at a relatively low incremental cost.

Slab-on-Grade Construction

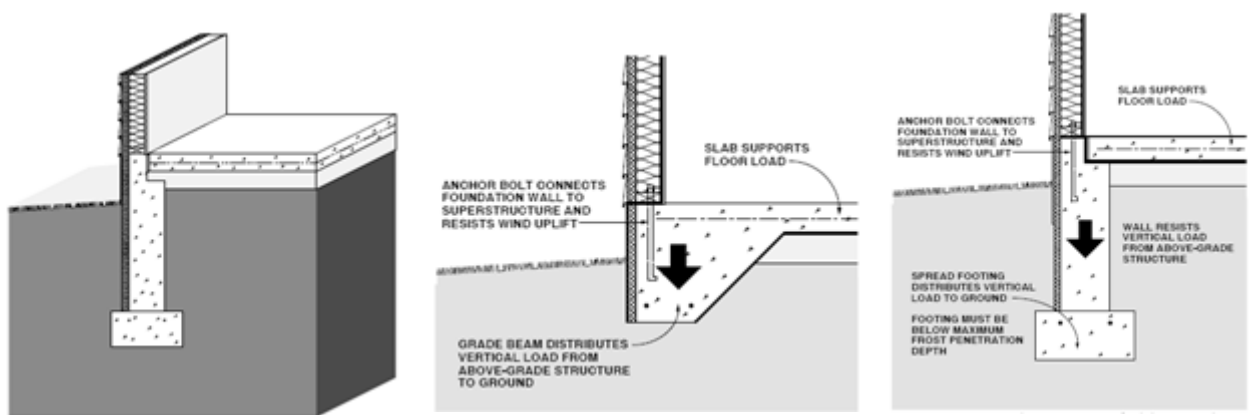

FIG 92 Slab-on-grade foundation /20/

The major structural components of a slab-on-grade foundation are the floor slab itself and either grade beams or foundation walls with footings at the perimeter of the slab. In some cases additional footings (often a thickened slab) are necessary under bearing walls or columns in the center of the slab. Foundation walls are typically constructed of cast-in-place concrete or concrete masonry units. Foundation walls must be designed to resist vertical loads from the structure above and transfer these loads to the footing. Concrete spread footings must provide support beneath foundation walls and columns. Similarly, grade beams at the edge of the foundation support the superstructure above. Footings must be designed with adequate bearing area to distribute the load to the soil and be placed beneath the maximum frost penetration depth or be insulated to prevent frost penetration. /20/

Good surface drainage techniques are always recommended for slab-on-grade foundations. The goal of surface drainage is to keep water away from the foundation by sloping the ground surface and using gutters and downspouts for roof drainage. Because a slab-on-grade floor is above the surrounding exterior grade, no layer above the surrounding ground. The most intense heat losses are through this small area of foundation wall above grade, so it requires special care in detailing and installation. Heat is also lost from the slab to the soil, through which it migrates to the exterior ground surface and the air. Heat losses to the soil are greatest at the edge, and diminish rapidly with distance from it. Both components of the slab heat loss

— at the edge and through the soil — must be considered in designing the insulation system. The techniques for minimizing radon infiltration

through a slab-on-grade foundation are appropriate where there is a reasonable probability that radon may be present . /20/

Foundations

B3 The National Building Code of Finland
Ministry of the Environment, Housing and Building Department
Regulations and Guidelines 2004

The soil conditions at the construction site shall be analysed in advance in connection with each building project. In general, and always in the case of category AA foundation construction objects, this shall be done by means of a soil exploration conducted at the construction site in connection with the building project. The contours of surface, the layer structure of subgrade, the location of rock surface, the properties of soil layers and rock, and groundwater relations concerning the construction object and its affected zone, shall be determined by means of a soil exploration in such a way that sufficient data is obtained to make it possible to design the foundations and to construct them technically in an appropriate and safe way. In addition, a soil exploration shall include an investigation of the location, quality and condition of the foundations of buildings and structures, as well as the substructures located at the construction site and in its vicinity in an extent deemed necessary.

The average level and the variation limits of groundwater shall be determined by means of groundwater observations made in connection with the soil exploration.

The capillarity and other properties in respect of moisture of the soil materials in contact with structures resting against the ground shall be investigated in such a way that harmful effects of moisture transferred from the ground into the structures can be prevented. The capillarity of material used in the drainage layers to be built underneath a floor resting against the ground, and outside walls resting against the ground, shall be sufficiently low so that the drainage layer reliably cuts off harmful horizontal and vertical capillary transfer of water into the structures.

By means of observations and investigations made in connection with a soil exploration, such initial data on freezing of the building ground shall be obtained, on the basis of which preventive measures to protect against possible damage caused by freezing can be planned and implemented.

In the design and construction work, radon risks at the construction site shall be taken into account.

Foundation design includes, in general, geotechnical design and structural design of foundations. Foundations shall be designed taking into account the climate, soil, ground, surface and open waters, foundations of nearby buildings and structures, as well as other ground constructions. In addition, attempts shall be made to forecast future development, excavations and land filling, as well as possible variations in the groundwater level so that their impacts can be taken into account and the future development is not unnecessarily hindered.

If founding of a building or a structure against the ground is not possible or reasonable due to the magnitude of settling, displacement or rotation caused by loads on the foundations, breaking of the subgrade or insufficient stability or for some other reason, such as the location of or the foundation methods used for founding the surrounding buildings and structures, the building shall be founded on piles on a deeper bearing stratum or on rock.

3.3 Sound insulation

/2/

Sound refers to mechanical vibration in an elastic medium. The medium can be gas, fluid or solid material. Different terms are used to refer to sound depending on the medium in which the sound wave propagates. Sound propagating in air is called airborne sound and humans sense it by hearing. Sound propagating in the structures of a building is called structure-borne sound, and when it is strong enough, humans sense it as vibration. Despite the differences between airborne sound and structure-borne sound they have a mutual connection, because airborne sound can create structure-borne sound and structure-borne sound almost always creates airborne sound.

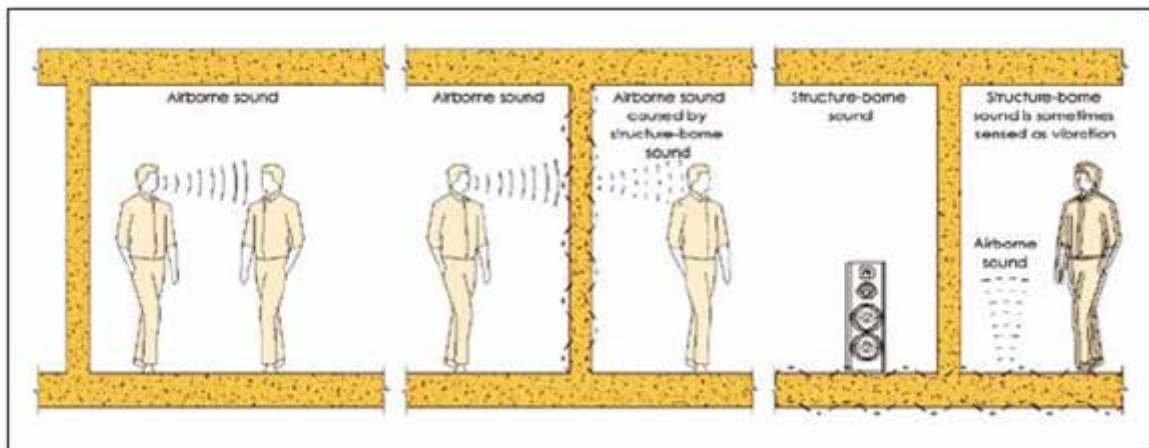

FIG 93 Airborne and structure-borne sound. /2/

The sound environment of a residential building

Airborne sounds are created by almost all activities taking place in an apartment. In addition to human activity, airborne sounds are created by the building's service systems and the like. In connection with normal living, impact sounds are created by walking on floors separating apartments and by all impacts directed towards the floor, such as the cleaning and moving of furniture. Impacts directed towards the floor make the floor vibrate, which creates airborne sound in another apartment.

Sounds are also carried into apartments from activities outside the building, such as traffic. The sounds of airline and railway traffic in particular may be carried into a building as disturbing airborne and structure-borne sounds. Within a building, sound propagates between apartments along different paths. The most typical of these is direct propagation through the structures between apartments.

In addition to this, flanking transmission paths such as structures extending from one apartment to another are often found between apartments. Building service systems such as ventilation ducts, radiator pipes etc. can also form flanking paths.

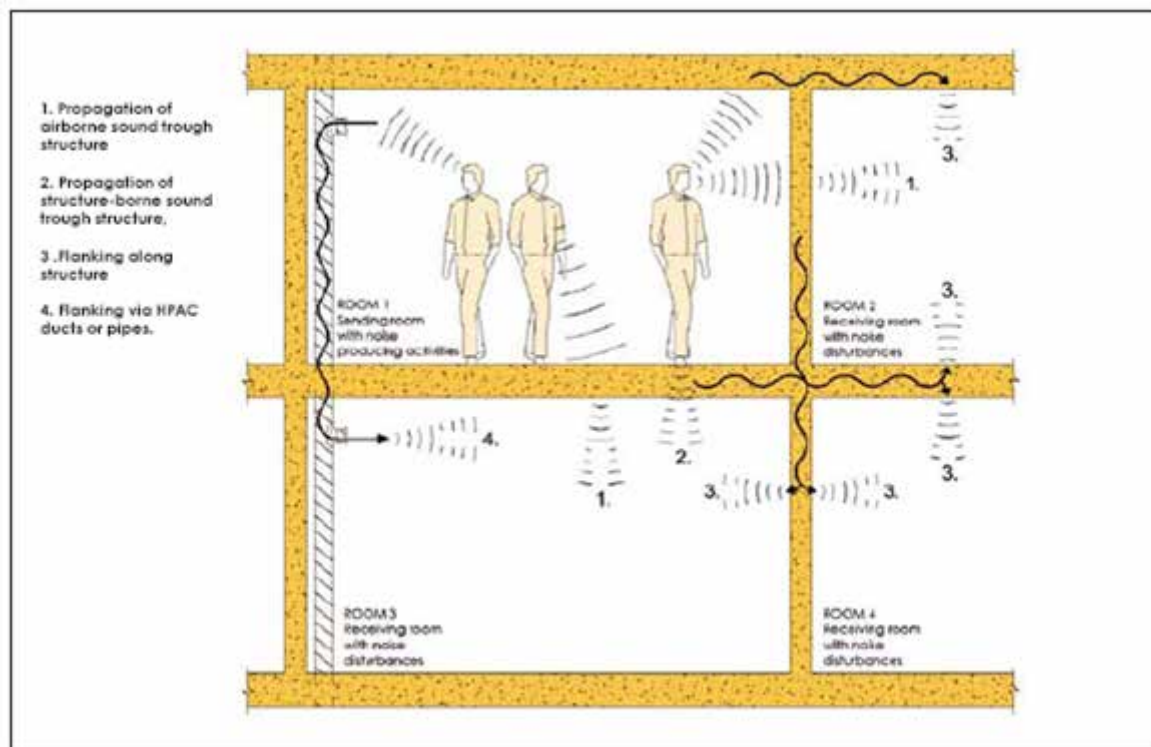

FIG 94 Sound /2/

Frequency and sound spectrum

Frequency (of sound) refers to the number of vibrations of the sound wave per second and its unit is hertz [Hz]. The greater the frequency, the higher the sound is perceived as being. When the frequency is low or high enough, humans will not hear any sound at all. A person with normal hearing can hear sounds in the frequency range from 16 Hz to 16,000 Hz, whereas a dog's audibility range, for example, extends from 70 Hz to 100,000 Hz. In practice, sounds usually contain many components in different frequency ranges. This is why sound is normally described by sound spectrum. Sound spectrum (and frequency range) is crucial for the design of sound-insulating structures, because the behaviour and sound insulation of a structure will change with frequency. Designing sound-insulating structures is demanding, because the structure must be made to work as a good sound insulator at low as well as high frequencies. /2/

Sound frequencies in residential buildings

The frequency ranges of sounds in residential buildings vary greatly. For example, human speech produces sound at frequencies from 50 Hz to 10,000 Hz, and walking on a floor produces sound from 25 Hz to 200 Hz. Human hearing is most sensitive in the frequency range from 100 Hz to 3,150 Hz. Due to this, the sound insulation of the structures of residential buildings has traditionally been studied in this frequency range in particular, and attempts have been made to achieve as good sound insulation performance as possible from the perspective of human hearing. Modern design of structural sound insulation tries to take into account low frequencies below 100 Hz as well. This is emphasised particularly in the design of light wall and floor structures, because they transmit low frequency sound quite easily. /2/

Volume of sound

Volume of sound is represented by the concept of the sound pressure level, which can be measured using a sound level meter. Sound pressure level is indicated as a numerical value, the unit of which is the decibel [dB]. The decibel is a logarithmic quantity, which means that sound pressure levels caused by individual sound sources cannot be directly added up using ordinary sum calculation. The total sound pressure level generated by individual sound sources can be determined using Equation 1.

$$L_{tot} = 10 \lg (10^{L_1/10} + 10^{L_2/10} + \dots + 10^{L_n/10})$$

L_{tot} = total sound pressure level [dB]
 L_i = sound pressure level of an individual sound source [dB]

Example 1

There are four sound sources in a room, each one separately causing a sound pressure level of 80 dB in the room. On the basis of Equation 1, the total sound pressure level of the sound sources is:

$$L_{tot} = 10 \lg (10^{80/10} + 10^{80/10} + 10^{80/10} + 10^{80/10}) = 86 \text{ dB}$$

Due to the fact that decibel values are logarithmic, it is difficult to understand the sound volume on the basis of the dB value indicating the sound pressure level. Table 1 indicates typical A-weighted sound pressure levels (sound levels) caused by different sound sources.

Sound source	A-weighted sound pressure level (sound level)
Threshold of hearing	0
Whisper of leaves	5 – 25
Computer	25 – 50
Loud speech	50 – 70
Traffic	70 – 85
Motorcycle	85 – 90
Disco	90 – 110
Threshold of pain	110 – 130
Jet engine	150

According to Table 1, for example, a computer may generate a sound level of 50 dB. 50 dB seems to be a large number, but the sound energy is substantially lower than, for example, an 85 dB sound level caused by traffic. The difference between sound levels caused by a computer and traffic is only 35 dB, but the difference in the energy of sound is very large. A total of 3,162 similar computers would be needed to generate a sound level of 85 dB.

Sound insulation of a structure

The airborne sound insulation of a structure refers to the capacity of the structure to block airborne sound between different spaces and is represented by the sound reduction index (transmission loss). If the weighted sound reduction index has been determined for a structure in a laboratory, it is designated R_w [dB]. If the weighted sound reduction index has been determined between rooms in a finished building, it is designated $R'w$ [dB]. The greater the sound reduction index, the better the airborne sound insulation of the structure.

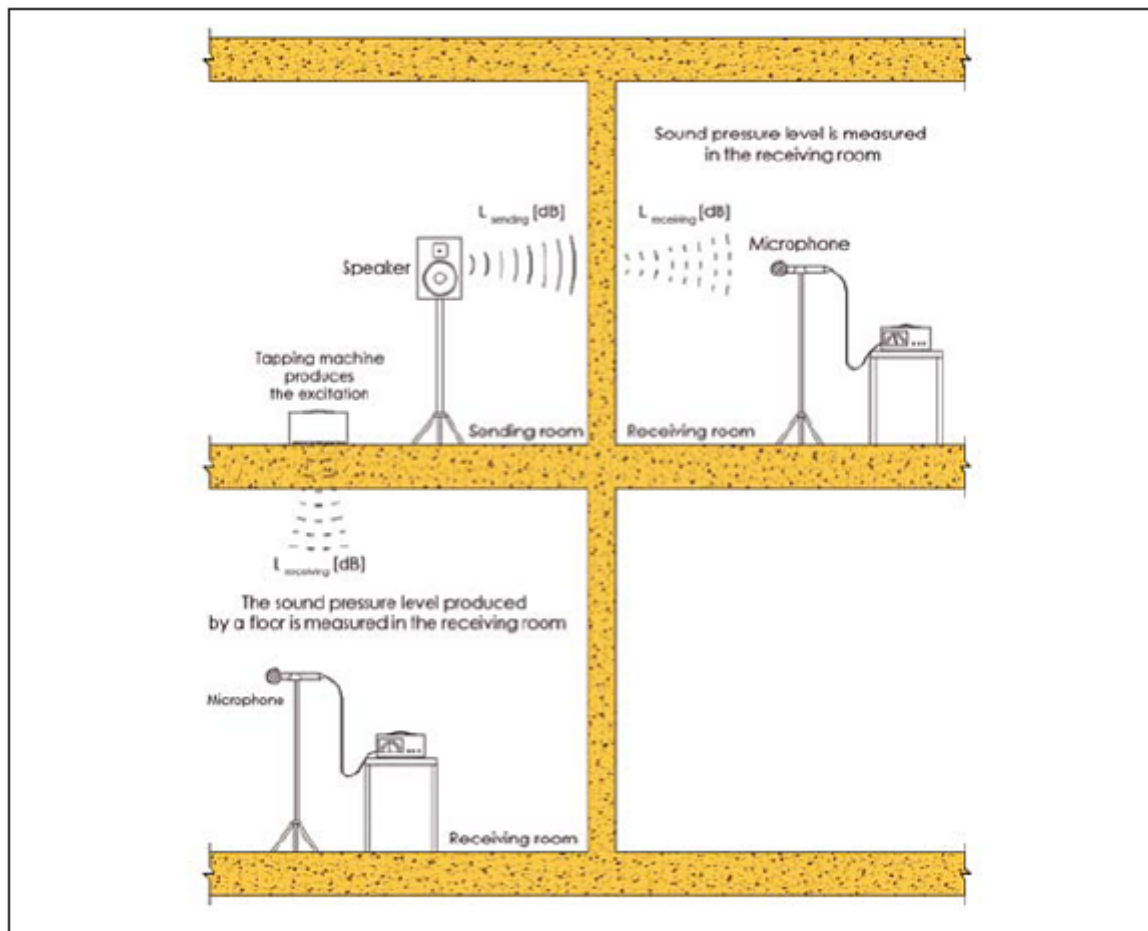

FIG 95 Sound /2/

The impact sound insulation of a structure refers to the capacity of a floor to generate airborne sound in another apartment with a certain standard impulse (tapping machine) and is indicated by the normalised impact sound level. If the weighted normalised impact sound level has been determined for a structure in a laboratory, it is designated $L_{n,w}$ [dB]. If it has been determined between rooms in a finished building, it is designated $L'_{n,w}$ [dB]. Contrary to the case of airborne sound insulation, a smaller impact sound level figure indicates better impact sound insulation. Flanking transmissions, the area of the structure and the properties of the receiving room affect the airborne and impact sound insulation between rooms. Thus, the sound insulation between rooms can only be precisely determined by measurements in a finished building. /2/

Sound insulation requirements for residential buildings

Within the National Building Code of Finland, Part C1 1998 Sound insulation and noise abatement in a building defines the sound insulation requirements presented in Figure 6 for the structures of a residential building. These do not apply to sounds originating in rooms in occasional use, such as bathrooms or saunas. However, the rooms in question must be taken into consideration when designing the sound conditions of a building. In order to gain a better understanding of the sound insulation of a structure, the connection between sound insulation and speech is illustrated in Table 3.

The National Building Code specifies a maximum weighted normalised impact sound level of 63 dB from exit routes into apartments. However, the design of sound insulation in buildings should provide better impact sound insulation than the requirement. This is recommended because impact sounds from the stairs are regarded as unpleasant, especially at night. The National Building Code does not specify any sound insulation requirement for the outer shell of a residential building. If necessary, this will be indicated by land-use plan regulation. A sound insulation requirement for the outer shell of a residential building is usually set if the building is located in an area with unusually strong traffic noise.

The sound insulation requirements specified in the National Building Code are intended to ensure sufficiently good sound conditions in a residential building. In addition to structures with good sound insulation, the sound conditions of a residential building can be influenced by architectural planning.

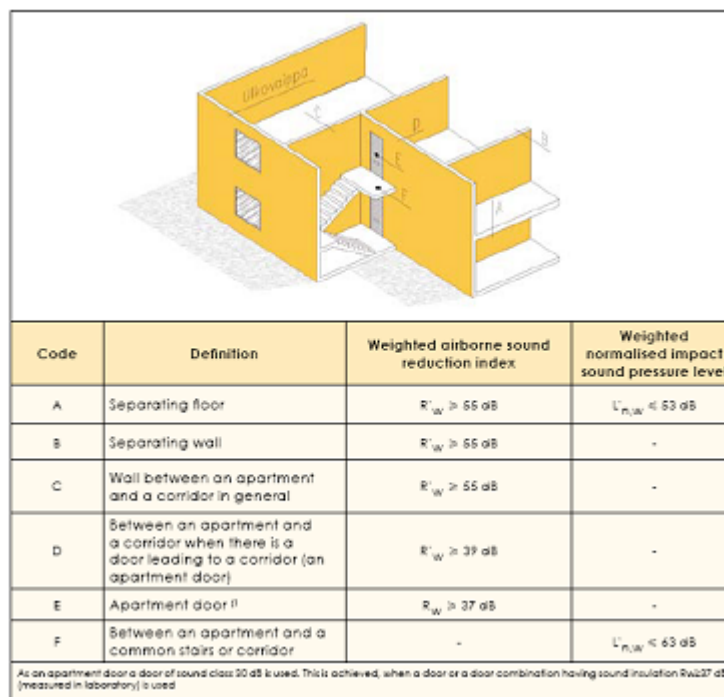

FIG 97 Sound /2/

Acoustics of structures

A structure is acoustically simple if it is made of the same material all over, or if the layers of different materials are in such solid contact with each other that they vibrate as a single entity. The sound insulation of a simple structure is mainly based on the air tightness and mass of the structure.

Mass law

When a sound wave meets a structure, it generates vibration in the structure. The more a structure vibrates, the more sound it creates on the other side of the structure. The same sound pressure creates more vibration in a light structure compared to a heavy one, so a heavy structure insulates sound better. This is called the mass law of sound insulation. According to the simple mass theory, the airborne sound insulation of a structure at different frequencies can be approximated using Equation 2. By determining the sound reduction index of a structure at a frequency of 500 Hz, the magnitude of the structure's weighted sound reduction index R_w

can be indicatively estimated in some cases. The exact weighted sound reduction index of a structure is determined using the reference curve method on the basis of measurement results over the entire frequency range.

Equation 2.

$$R = 20 \lg (mf) - 49$$

In Equation 2

R = sound reduction index of the structure [dB]

m = surface mass of the structure [kg/m²]

f = frequency [Hz]

Example 2

Estimating the airborne sound insulation of a concrete wall with a thickness of 180 mm (m=450 kg/m²) at a frequency of 500 Hz using

$$R_{500} = 20 \lg (450 \times 500) - 49 = 58 \text{ dB}$$

(approximately corresponding to the weighted reduction index R_w of the wall in question)

However, the mass law holds only in general outline because the sound insulation of structures lighter than 100 kg/m² increases less rapidly than that of structures heavier than 100 kg/m² as the mass increases. However, when a structure is very heavy, its sound insulation cannot be essentially improved by any small increase in mass. Thus, the addition of mass will only be economically feasible from the sound insulation point of view when the structure is originally light. It can be considered a rule of thumb that when the surface mass of a structure is doubled, its airborne sound insulation improves by 4 to 6 dB. Structures that insulate sound on the basis of their mass include concrete and similar "massive structures". In brick structures, the density of the bricks and the finish layers has an essential effect on the airborne sound insulation of the structure. /2/

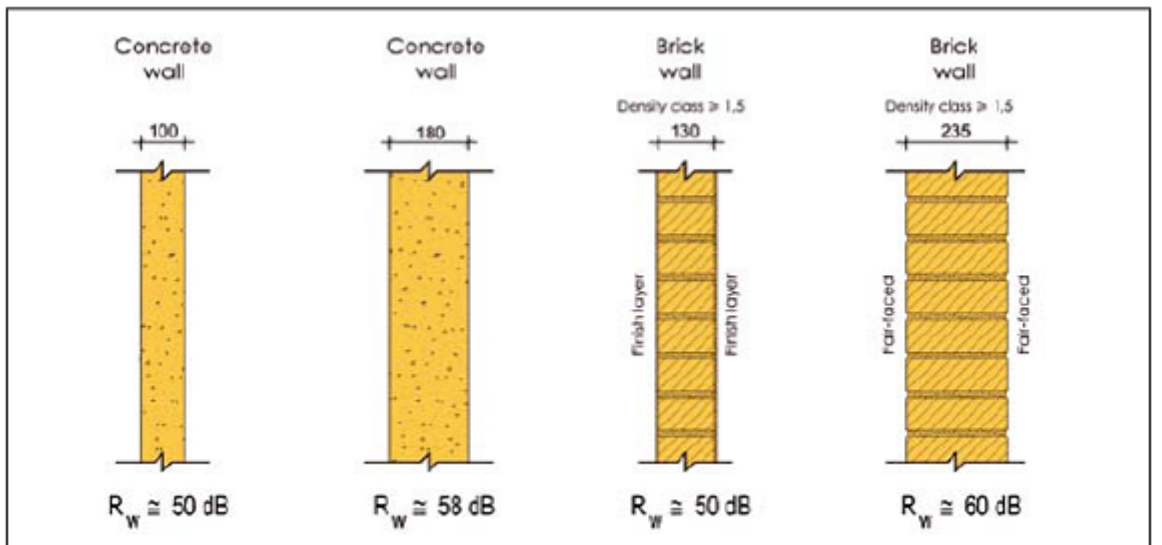
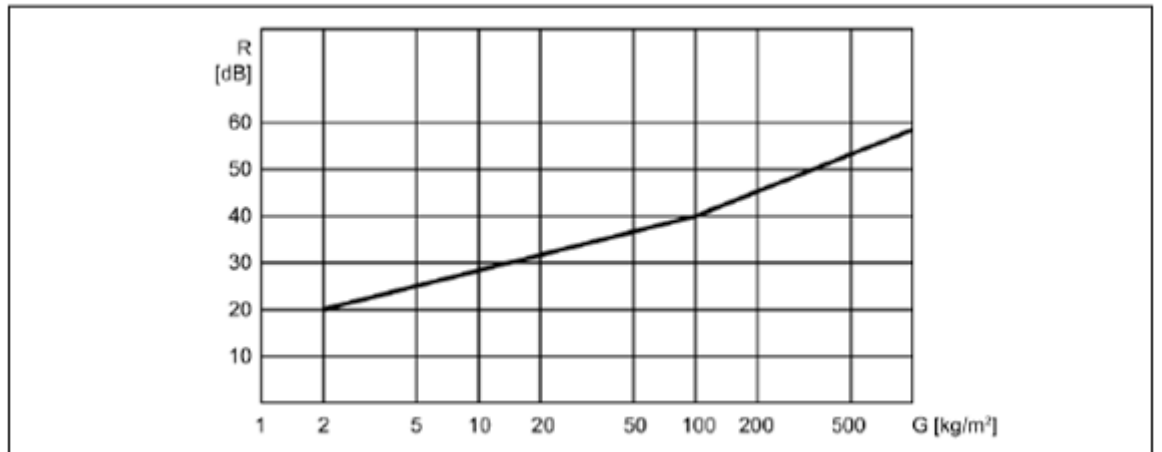
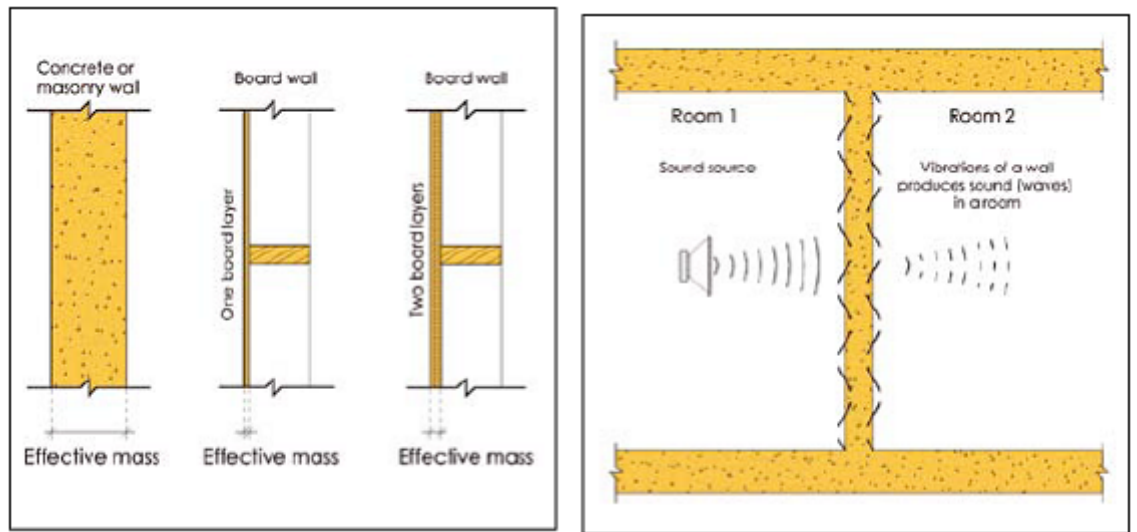

FIG 98 Sound /2/

Resonance phenomenon

The resonance phenomenon occurs in a structure when it is hit by sound waves with a frequency falling into the resonance frequency range or natural frequency range of the structure. The resonance phenomenon makes the structure vibrate and radiate sound intensively, which causes a reduction in its sound insulation. The strong vibration of the structure is due to the fact that the vibration system within the structure continuously gains more energy from the sound waves directed at it. The resonance phenomenon can be illustrated with the following example: The speed of a swing accelerates when you swing it at the right pace. The speed has to be increased when the swing goes forward.

The resonance frequency range of a structure can be determined on the basis of its lowest natural frequency f_0 [Hz] at which the structural vibration reaches its maximum value. The resonance phenomenon can also be observed when the frequency of the excitation causing the vibration is close to the lowest natural frequency of the structure, in other words when the excitation is in the resonance frequency range of the structure. The resonance frequency range of a structure should be below the frequency range from 100 Hz to 3,150 Hz, which is important for sound insulation with regard to human hearing. The resonance phenomenon can also occur between a device generating vibration and a structure. In this case, the device makes the structure vibrate if the excitation frequency of the device falls into the resonance frequency range of the structure. Such a resonance phenomenon may be created, for example, between a washing machine and a floating floor. For this reason, the excitation frequency of a vibrating device must be sufficiently above or below the natural frequency of a structure. /2/

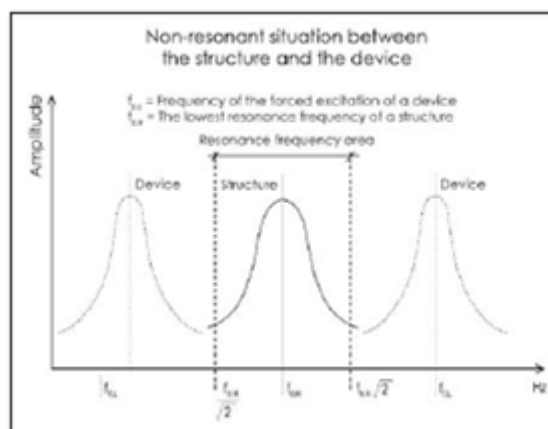

FIG 99 Sound /2/

Coincidence phenomenon

The coincidence phenomenon occurs, for example, in a panel. In the coincidence phenomenon, the trace of a sound wave front impinging the panel surface at a certain angle of incidence and the bending wave within the panel propagate at equal velocity. In this case, a constant sound causes a wave front that coincides with the bending wave within the panel. When the sound propagates, the situation remains the same all the time, and the panel does not insulate sound nearly as effectively as could be expected on the basis of its mass. In the coincidence phenomenon, the sound waves penetrate the panel, and its sound insulation mainly depends on the loss mechanisms of the panel and the structure. Every simple panel or plate structure has a coincidence frequency, f_c ; the coincidence phenomenon occurs at frequencies higher than this, and the sound insulation of the structure decreases. Because of this, the coincidence frequency of a structure should be above the frequency range from 100 Hz to 3,150 Hz, which is important for human hearing. The coincidence phenomenon is generally not a problem with thick and heavy, simple "massive structures". On the other hand, its effect on the sound insulation

of thin, simple “concrete and brick structures” must be considered in design. The coincidence frequency of thin building panels is usually in the range of 2,000 Hz to 3,000 Hz. The higher the coincidence frequency of a building board, the smaller the effect of the coincidence phenomenon on the sound insulation of a structure. /2/

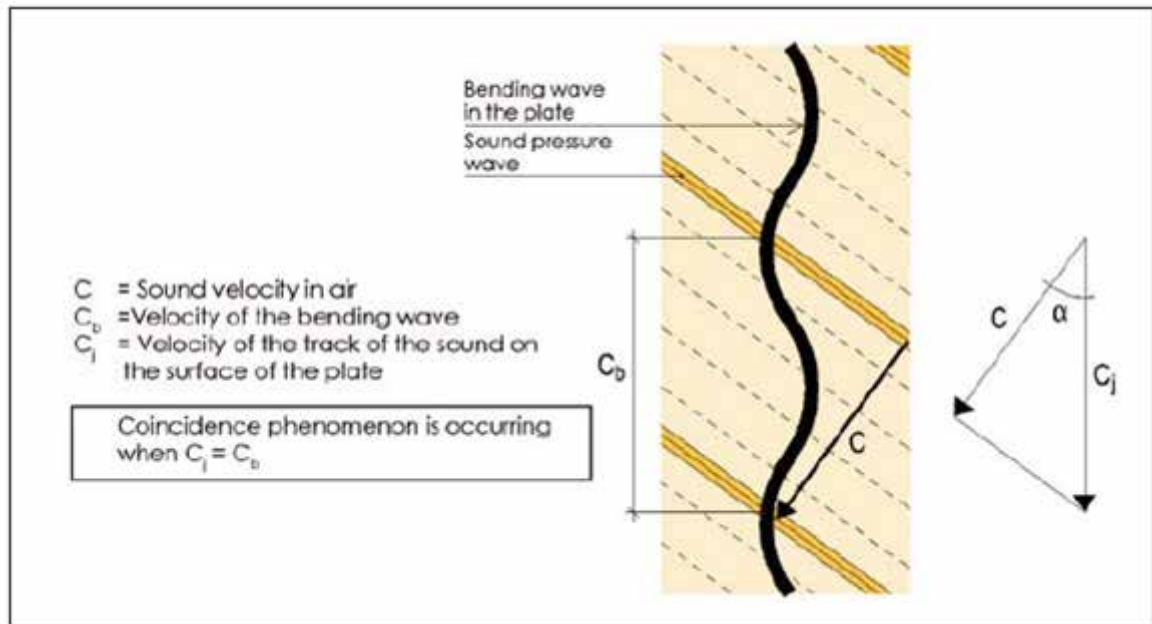

FIG 100 Sound /2/

The coincidence frequency of a simple structure can be determined using Equation 3.

Equation 3.

$$f_c = \frac{c^2}{2\pi h} \times \sqrt{\frac{12g(1-\mu^2)}{E}}$$

In Equation 3

f_c = coincidence frequency [Hz]

c = sound velocity in air (about 340 m/s)

h = thickness of the structure [m]

g = density of the structure [kg/m³]

μ = Poisson's ratio (0.3)

E = modulus of elasticity (Young's modulus) [N/m²]

Example 3

Calculating the coincidence frequency of a plasterboard panel of 13 mm thickness using Equation 3.

$$f_c = \frac{340^2}{2 \times \pi \times 0,013} \times \sqrt{\frac{12 \times 700 \times (1 - 0,3^2)}{1700 \times 10^6}} \approx 3000 \text{ Hz}$$

FIG 101 /2/

Calculating the coincidence frequency of a plasterboard panel of 13 mm thickness using Equation 3. If a structure has several superimposed layers of panels that are not glued to each other, the coincidence frequencies shall be determined for each panel layer separately. Figure 15 illustrates the measurement results for the sound insulation of simple plasterboard of 13 mm thickness; it can be noticed that the airborne sound insulation of the board decreases substantially as the frequency approaches the coincidence frequency of the panel (3,000 Hz).

If the case of Example 3 involved two plasterboards glued to each other, the two thin panels would become one thick panel with a coincidence frequency of about 1,500 Hz. In this case the “coincidence dip” of the panel would almost completely move to the frequency range from 100 Hz to 3,150 Hz. Therefore, it is better from the sound insulation point of view that superimposed panels are not glued to each other. /2/

Acoustic behaviour of a double wall

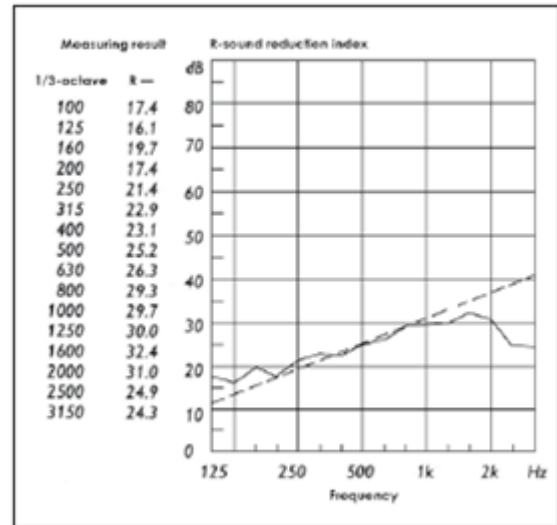
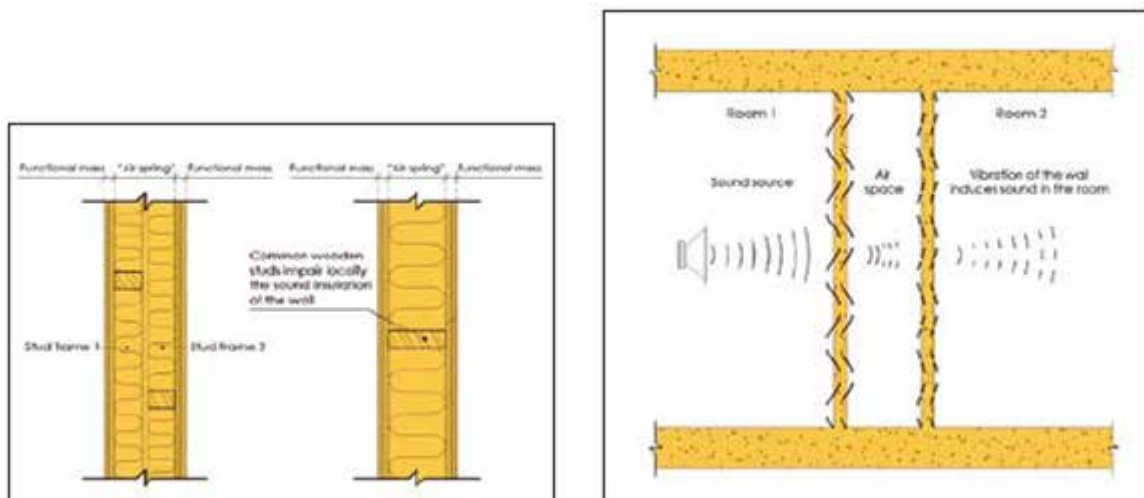

FIG 102 Sound /2/

A double wall forms a spring-mass system, the sound insulation of which is based on the interaction of two masses separate from each other (functional mass) and the air space between them, in other words the “air spring”. In a double wall the impinging sound waves make one half of the wall vibrate. The air space between the boards serves as a “spring”, transmitting the oscillating motion to the other half of the wall .

The following sections mostly discuss a double wall with two frames separated from each other (double-frame walls) because the Finnish sound insulation requirements for residential buildings can only be fulfilled with this type of wall structure.

Effect of the mass of structure layers on the sound insulation of a double wall

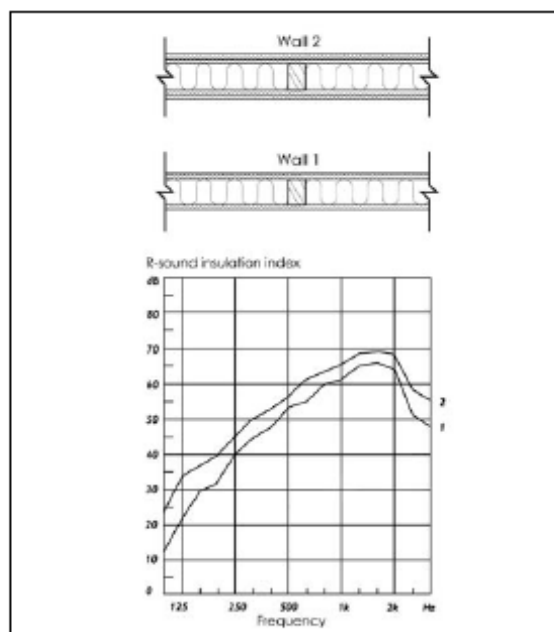

Figure 18. Effect of the mass of the panels on the sound insulation of a wall (Gyproc guide book).

FIG 103 /2/

Based on the mass law, increasing the mass of the boards in a double wall will improve its sound insulation

Effect of the air space between the structure layers on the sound insulation of a double wall

The thicker the air space between the boards, the more flexible it is and thus it transmits less vibration to the other half of the wall, improving its sound insulation . A thin air space is enough for heavy “massive structured” double walls, but in the case of light double-framed board walls, the thickness of the air space must be at least 145 mm in order to fulfil the sound insulation requirement for walls between apartments.

At high frequencies, standing waves are formed in the air space of a double wall, reducing its sound insulation. The effect of standing waves is reduced by installing sound-absorbent material, such as mineral wool or wood fibre insulation material, in the air space. The air space can be completely filled with light absorbing material, so for example wood fibre insulation can also be installed by blasting. The sound insulation of a wall can be improved by 6 dB on aver-

age by filling the air space with sound-absorbent material. The softer the absorbing material, the greater an improvement can be achieved. For example, when using soft mineral wool, the improvement effect is in the order of 5 to 15 dB.

Uniform board sheeting should not be installed in the air space of a double wall because in that case, the double wall becomes a triple wall, the sound insulation of which is lower than that of a double wall of equal mass and thickness. The impaired sound insulation is due to the fact that a triple wall generates several vibration subsystems and the mass-spring-mass resonance frequency of the wall rises.

Resonance phenomenon in a double wall

The sound insulation of a double wall increases rapidly above the mass-spring-mass resonance frequency range but within the resonance frequency range, the sound insulation of a double wall is often worse than that of a simple wall of equal mass . Thus the massspring-mass resonance frequency of a double wall should be as low as possible.

The resonance frequency of a double-framed wall with sheeting of equal weight on both halves can be approximated with Equation 4. If the frame halves are of unequal weight, Equation 5 shall be used. In both Equations 4 and 5, the effect of the stiffness of the frame halves is neglected.

Equation 4

$$f_0 = \frac{85}{\sqrt{md}}$$

Equation 5

$$f_0 = 60 \sqrt{\frac{m_1 + m_2}{m_1 m_2 d}}$$

In equations 4 and 5

f₀ = the mass-spring-mass resonance frequency of the wall [Hz]

m= surface mass of the board/boards on one side [kg/m²]

m₁= surface mass of the board/boards on side 1 [kg/m²]

m₂= surface mass of the board/boards on side 2 [kg/m²]

d = thickness of the air space [m]

Example 4. Calculation of the resonance frequency of a double-framed wall using

Example 4. Calculation of the resonance frequency of a double-framed wall using Equation 4.

$$f_0 = \frac{85}{\sqrt{18 \times 0.145}} = 53 \text{ Hz}$$

FIG 104 Sound /2/

The calculated lowest resonance frequency of the double-framed wall in Example 4 is 53 Hz, which means that in practice, the wall in question insulates sound effectively in the frequency range from 100 Hz to 3,150 Hz, which is important for human hearing.

Coincidence phenomenon in a double wall

The coincidence frequency for the boards in a double wall is determined using Equation 3 and should be as high as possible so that the coincidence phenomenon weakens the sound insulation of the wall as little as possible. Thus, thin building boards have to be used in the wall and they should not be glued to each other. /2/

Effect of the coupling between the frame halves of a double-framed wall on its sound insulation

In order to fulfil the sound insulation requirement for a wall between apartments using a double-framed wall, no mechanical coupling between the separate frames is allowed. Thus there has to be an air gap between the frame halves and in addition to this, it is recommended that the studs be installed at different locations in the frame halves. If studs wider than the bottom and top guide beams are used, the bottom and top ends of the studs must be bevelled in accordance with the principles. However, a double-framed wall can be attached to a structure connecting the frame halves. /2/

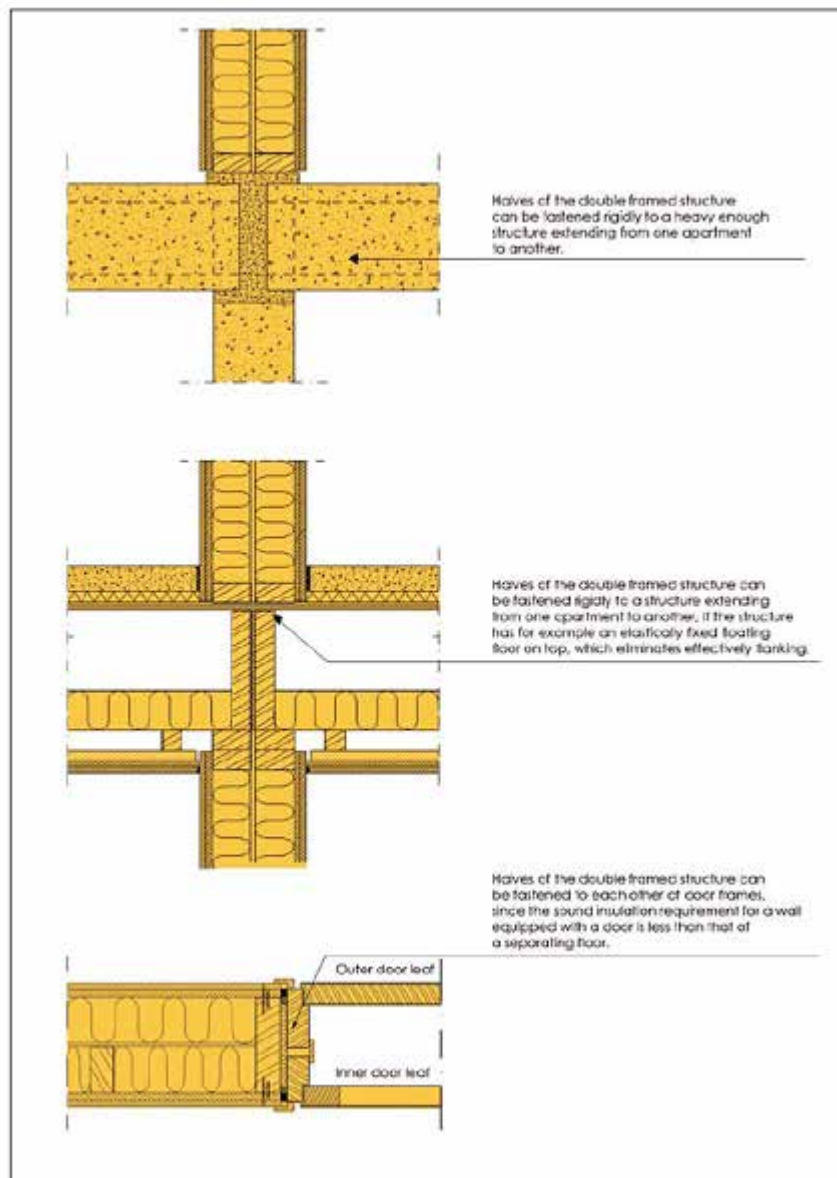

FIG 105 Sound /2/

Acoustic behaviour of a double floor

Like a double wall, a double floor structure serves as a spring-mass system where the functional masses are the suspended ceiling sheeting and a superstructure (semi-massive or multilayer) on top of the floor joists. The air space between the functional masses serves as an "air spring". In order to fulfil the sound insulation requirements for residential buildings using a wooden floor, the floor must include a resiliently suspended ceiling sheeting (resilient mounting bars or channels), as well as a floating floor or a sufficiently elastic floor covering with a solid deck structure. With regard to impact sound insulation, the behaviour of a light double considerably deviates acoustically from that of a solid floor (a concrete floor). The impact sound pressure levels of light floors are naturally very low at high frequencies and high at low frequencies. The situation is the opposite in a heavy solid concrete floor. The consequence of this is that at high frequencies the improvement effect of a light floating floor or elastic floor covering on top of a light floor is quite limited compared with the improvement achieved on top of a heavy concrete barefloor.

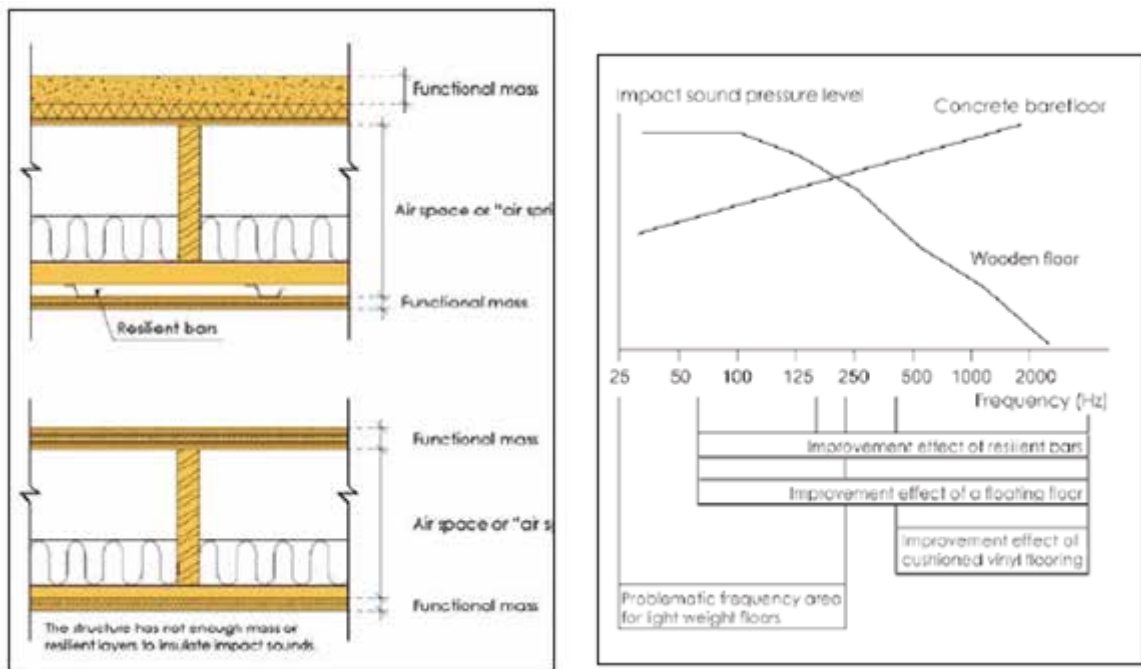

FIG 106 /2/

Flanking transmission through structures and junctions

Sound can also propagate between apartments through adjoining structures and junctions. Flanking transmission caused by structures can be eliminated or its effect reduced in accordance with the following principles:

1. Cutting off the flanking paths (by decoupling the structures) or using elastic layers as sound cut-offs along the flanking transmission paths.
2. Using heavy non-vibrating structures as adjoining structures extending from one apartment to another.
3. Attaching the structures to each other in a flexible manner (decoupling).

Figures 39 and 40 present the flanking paths of sound between apartments through connecting structures and the possibilities of reducing/ eliminating the effect of flanking

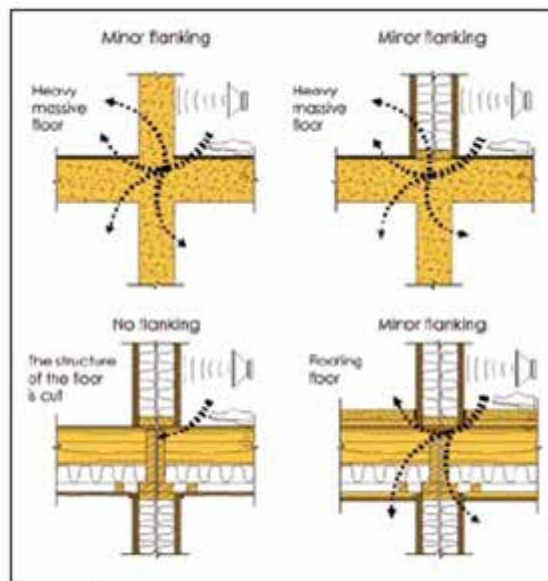

FIG 107 Sound

Acoustic design related to exit routes

Acoustically, a single door leaf behaves like a simple structure, while a door combination comprising two separate door leaves behaves like a double structure. The front door of an apartment is usually fitted with a mail drop that substantially decreases the sound insulation of the door. Therefore, the front door of an apartment should always be implemented in the form of a door combination comprising two door leaves, in order to achieve an acoustically good solution.

Reverberation time and sound absorption

If the reverberation time of a room is too long, this will usually be experienced as disturbing and reverberation will make it difficult to understand speech. In residential buildings, the reverberation time requirement is set only for exit routes. Within the National Building Code of Finland, Part C1 1998 Sound insulation and noise abatement in a building defines the maximum reverberation time of an exit route as 1.3 seconds if the exit route provides access to at least two apartments. Approximation of the reverberation time of a room can be carried out by determining the total absorption area of the room. This can be done with the help of Equation 8.

The quantity describing the ability of a product to absorb sound is indicated by the absorption coefficient. If the absorption coefficient of a material is 0, its surface reflects all sound directed at it, and if the absorption coefficient is 1, all of the sound energy directed at the surface is absorbed by the material. In a simple case, the absorption coefficient of a material can be chosen from the absorption curve of the product at a frequency of 500 Hz.

The walls and ceilings of staircases in wooden residential buildings are mostly compiled of board structures which absorb some sound. Therefore, much additional absorptive material is not usually required in the corridors in order to fulfil the reverberation time requirement. The reverberation time can be determined using

Equation 9.

Equation 8

$$A = \sum_1^n \alpha_n S_n + 4kV$$

Equation 9

$$T = 0,16 \frac{V}{(4kV + A)}$$

In Equation 8

A = total absorption area of the room [m²]

α_n = absorption coefficient of sub-area

S_n = area of the sub-area [m²]

k = absorption coefficient of the air from Figure 51

V = volume of the room

In Equation 9

T = reverberation time [s]

V = volume of the room

k = absorption coefficient of the air from Figure 51

A = total absorption area of the room frequency of the resiliently suspended ceiling [Hz]

Example 6.

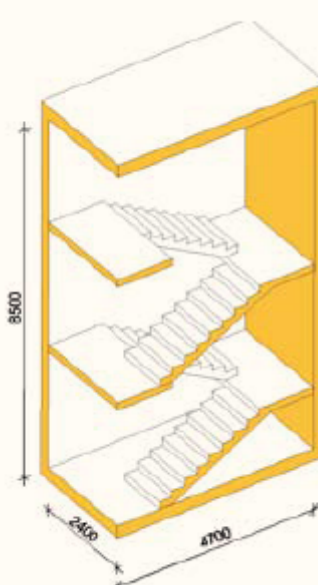

Calculation of the reverberation time of a staircase with absorptive boards (average absorption coefficient $\alpha = 0,08$) in the ceiling. Walls and ceiling are compiled of wooden board structures and the floor is hard surfaced (concrete). In the walls there are four doors.

Floor:	$A = 11,3 \text{ m}^2$	$\alpha = 0,02$
Door:	$A = 7,5 \text{ m}^2$	$\alpha = 0,08$
Ceiling:	$A = 3,2 \text{ m}^2$	$\alpha = 0,1$
Seinät:	$A = 113,0 \text{ m}^2$	$\alpha = 0,1$
Absorptive ceiling boards:	$A = 8,0 \text{ m}^2$	$\alpha = 0,8$
Volume of the room	$V = 96 \text{ m}^3$	

In the calculation the absorption effect of the air as well as the effect of stairs on the absorption area is neglected.

$$A = 11,3 \times 0,02 + 7,5 \times 0,08 + 3,2 \times 0,1 + 113,0 \times 0,1 + 8,0 \times 0,8 = 18,8 \text{ m}^2$$

$$T = 0,16 \times \frac{96}{18,8} = 0,8 \text{ s} < 1,3 \text{ s OK?}$$

FIG 108 Sound /2/

Building	Work number	
	Date	Checked
Designer	Content External wall	

Presented dB-values are based on literal sources.

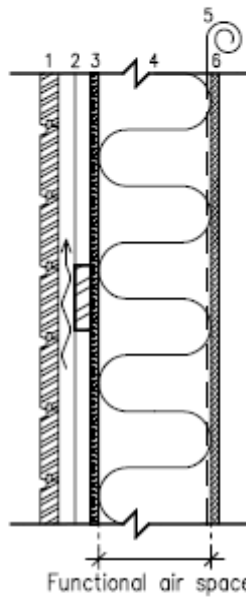

1. Outer board panel.
2. Battens and ventilated air space.
3. Breather board, soft board ($t \geq 12$).
4. Timber studs 48x172, spacing c/c 600mm at maximum, thermal insulation ($t=172$ mm).
5. Air and vapour barrier, joints on studs, overlap ≥ 200 mm.
6. Building board, surface mass $\geq 9\text{kg/m}^2$, for example plasterboard ($t \geq 13$ mm).
Type and number of building boards is also affected by fire requirements.

Sound insulation in traffic noise $R_w + C_{tr} \geq 38$ dB

The improvements in the Table below may be added to the insulation value above.

Improvement of the weighted airborne sound reduction index		
To be changed	Change	Improvement
Thickness of air space	172 mm → 220 mm	1 dB
Number of board layers on inner side of wall ¹⁾	1 board layer → 2 board layers	2 dB

¹⁾ The joints of superimposed boards shall be located on different studs.
Board layers must not be glued with each other.

FIG 109 External Wall /2/

Building	Work number	
	Date	Checked
Designer	Content External wall	

Presented dB-values are based on literal sources.

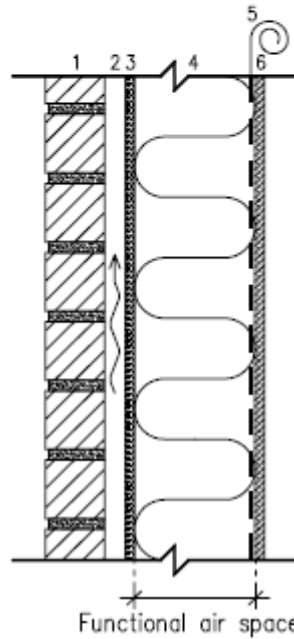

1. Brick veneer ($t \geq 85$ mm).
 2. Ventilated air space.
 3. Breather board, soft board ($t \geq 12$).
 4. Timber studs 48x172, spacing c/c 600mm at maximum, thermal insulation ($t=172$ mm).
 5. Air and vapour barrier, joints on studs, overlap ≥ 200 mm.
 6. Building board, surface mass $\geq 9\text{kg/m}^2$, for example plasterboard ($t \geq 13$ mm).
- Type and number of building boards is also affected by fire requirements.

Sound insulation in traffic noise $R_w + C_{tr} \geq 44$ dB

The improvements in the Table below may be added to the insulation value above.

Improvement of the weighted airborne sound reduction index		
To be changed	Change	Improvement
Thickness of brick	85 mm → 130 mm	2 dB
Thickness of air space	172 mm → 220 mm	1 dB
Number of board layers on inner side of wall ¹⁾	1 board layer → 2 board layers	1 dB

¹⁾ The joints of superimposed boards shall be located on different studs.
Board layers must not be glued with each other.

FIG 110 External Wall /2/

Building	Work number	
	Date	Checked
Designer	Content Truss roof	

Presented dB-values are based on literal sources.

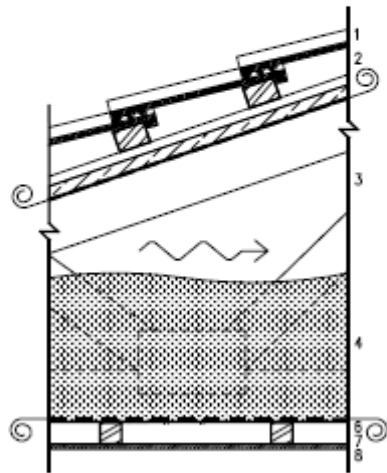

1. Concrete roofing tiles.
2. Battens and other substructure of roof.
3. Ventilated air space, ventilation air slot equipped with silencing structure (see chapter 17 Joints between structures).
4. NR-trusses + thermal insulation (loose wool or wool boards), ($t \geq 300$ mm).
5. Air and vapour barrier, joints on ties, overlap ≥ 200 mm.
6. Hard chipboard ($t \geq 3$ mm).
7. Ceiling battens, spacing 400...450 mm at maximum.
8. Building board, surface mass $\geq 9 \text{ kg/m}^2$, for example plasterboard ($t \geq 13$ mm), shall be jointed with vertical structures with elastic sealing compound.
Type and number of building boards is also affected by fire requirements.

Sound insulation in traffic noise $R_w + C_{tr} \geq 49$ dB

The improvements in the Table below may be added to the insulation value above.

Improvement of the weighted airborne sound reduction index		
To be changed	Change	Improvement
Roof	Tile roofing → Steel sheet roofing	0 dB
Fixing of ceiling	Battens → Resilient bars	5 dB
Ceiling	Building boards → Panelling	-3 dB (negative)
Number on superimposed board layers ¹⁾	1 board layer → 2 board layers	3 dB

¹⁾ The joints of superimposed boards shall be located on different battens or resilient bars. Board layers must not be glued with each other.

FIG 110 Truss Roof /2/

Building	Work number	
	Date	Checked
Designer	Content Roof with inclined beams	

Presented dB-values are based on literal sources.

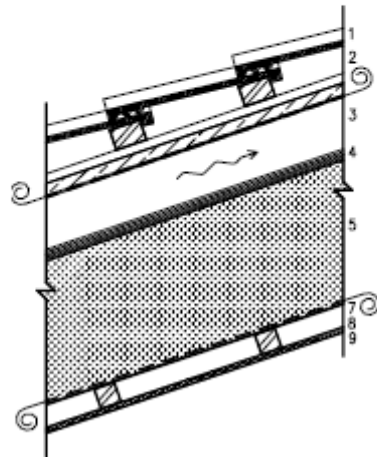

1. Concrete roofing tiles.
2. Substructure of roof.
3. Ventilated air space ($t \geq 100$ mm.)
4. Breather board, soft board ($t \geq 25$ mm).
5. Beams + thermal insulation (loose wool or wool boards), ($t \geq 275$ mm).
6. Air and vapour barrier, joints on beams, overlap ≥ 200 mm.
7. Hard chipboard ($t \geq 3$ mm).
8. Ceiling battens, spacing 400...450 mm at maximum.
9. Building board, surface mass $\geq 9\text{kg/m}^2$, for example plasterboard ($t \geq 13$ mm), shall be jointed with vertical structures with elastic sealing compound.
Type and number of building boards is also affected by fire requirements.

Sound insulation in traffic noise $R_w + C_{tr} \geq 48$ dB

The improvements in the Table below may be added to the insulation value above.

Improvement of the weighted airborne sound reduction index		
To be changed	Change	Improvement
Roof	Tile roofing → Steel sheet roofing	0 dB
Fixing of ceiling	Battens → Resilient bars	5 dB
Ceiling	Building boards → Panelling	-3 dB (negative)
Number on superimposed board layers ¹⁾	1 board layer → 2 board layers	3 dB

¹⁾ *The joints of superimposed boards shall be located on different studs.
Board layers must not be glued with each other.*

FIG 111 Roof /2/

16. Structures between apartments

Building	Work number	
	Date	Checked
Designer	Content Non load-bearing wall between dwellings	

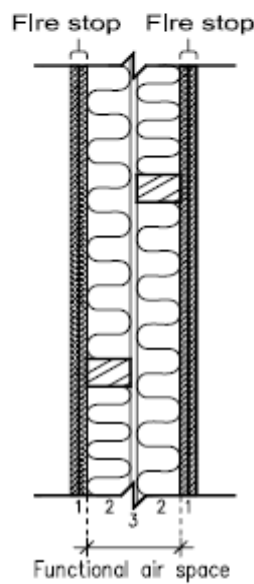

1. Building board¹⁾, surface mass $\geq 9\text{kg/m}^2$, for example plasterboard ($t \geq 13\text{ mm}$).
Building board¹⁾, surface mass $\geq 9\text{kg/m}^2$, for example plasterboard ($t \geq 13\text{ mm}$).
Type and number of building boards is also affected by fire requirements.
2. Wooden studs 45x70, stud of different frames shall be located on different places, spacing 600 mm at maximum.
Mineral wool ($t \geq 70\text{ mm}$).
3. Space between frames ($t \geq 5\text{ mm}$).

Weighted airborne sound reduction index $R'_w \geq 55\text{ dB}$

Factors affecting the sound insulation are presented in the Table below.
They may not be used to change the insulation value above.

Improvement of the weighted airborne sound reduction index		
To be changed	Change	Improvement
Surface mass of wall boards	$18\text{ kg/m}^2 \rightarrow 25\text{ kg/m}^2$	1...2 dB
Thickness of air space ²⁾	$145\text{ mm} \rightarrow 300\text{ mm}$	1...2 dB

¹⁾ The joints of superimposed boards shall be located on different studs or air barrier car or paper shall be used beneath boards. Board layers must not be glued with each other.

²⁾ The thickness of the functional air space shall be 145 mm at least.

Building	Work number	
	Date	Checked
Designer	Content Load-bearing wall between dwellings	

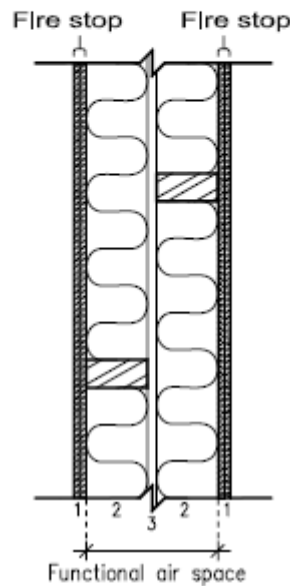

1. Building board¹⁾, surface mass $\geq 7 \text{ kg/m}^2$, for example chipboard ($t \geq 10 \text{ mm}$).
Building board¹⁾, surface mass $\geq 7 \text{ kg/m}^2$, for example chipboard ($t \geq 10 \text{ mm}$).
Type and number of building boards is also affected by fire requirements.
2. Wooden studs 48x97, stud of different frames shall be located on different places, spacing 600 mm at maximum.
Mineral wool²⁾ ($t \geq 97 \text{ mm}$).
3. Space between frames ($t \geq 5 \text{ mm}$).

Weighted airborne sound reduction index $R'_w \geq 55 \text{ dB}$

Factors affecting the sound insulation are presented in the Table below.
They may not be used to change the insulation value above.

Improvement of the weighted airborne sound reduction index		
To be changed	Change	Improvement
Surface mass of wall boards	$14 \text{ kg/m}^2 \rightarrow 20 \text{ kg/m}^2$	1...2 dB
Thickness of air space ³⁾	$200 \text{ mm} \rightarrow 300 \text{ mm}$	0...1 dB

¹⁾ The joints of superimposed boards shall be located on different studs or air barrier car or paper shall be used beneath boards. Board layers must not be glued with each other.
²⁾ If the fire safety requirements allow also loose wood fibre wool may be used.
³⁾ The thickness of the functional air space shall be 200 mm at least.

FIG 113 Bearing Wall /2/

Building	Work number	
	Date	Checked
Designer	Content	
Floor between dwellings		

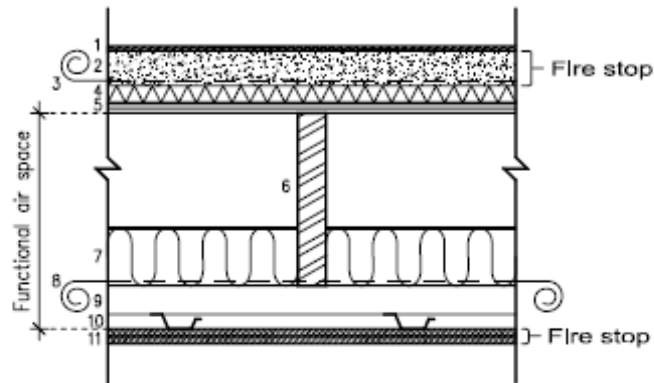

1. Floor covering may be chosen freely.
2. Floating concrete slab ($t \geq 80$ mm).
3. Filter fabric, joints with overlap ≥ 200 mm.
4. Impact sound insulation layer, dynamic stiffness $s' < 20$ MN/m³.
5. Spruce plywood ($t \geq 18$ mm), grooved and tongued around the board.
6. Joists (beams or trusses), spacing c/c 600 mm at maximum.
7. Mineral wool board¹⁾ ($t \geq 100$ mm).
8. Air barrier paper or card, joints on joists, overlap ≥ 200 mm + tape.
9. Ceiling battens, spacing 400 mm at maximum for supporting the wool.
10. Resilient bars with spacing of 400 ... 450 mm at maximum for supporting the boards.
11. Building board²⁾, surface mass ≥ 9 kg/m², for example plasterboard ($t \geq 13$ mm).
Building board²⁾, surface mass ≥ 9 kg/m², for example plasterboard ($t \geq 13$ mm).
Type and number of building boards is also affected by fire requirements.

Weighted sound reduction index $R'_w \geq 55$ dB

Weighted normalised impact sound level $L'_{n,w} \leq 53$ dB

Factors affecting the impact sound insulation are presented in the Table below.

They may not be used to change the value of the weighted normalised impact sound pressure level above.

Factors affecting the impact sound insulation		
To be changed	Change	Improvement
Weight of the concrete slab	$150 \text{ kg/m}^2 \rightarrow 200 \text{ kg/m}^2$	1...2 dB
Thickness of air space ³⁾	$200 \text{ mm} \rightarrow 450 \text{ mm}$	1...2 dB
Surface mass of ceiling	$18 \text{ kg/m}^2 \rightarrow 25 \text{ kg/m}^2$	1...2 dB

¹⁾ Also loose wood fibre wool may be used according to fire requirements.

²⁾ The joints of superimposed boards shall be located on different resilient bars.
Board layers must not be glued with each other.

³⁾ The thickness of the functional air space shall be 200 mm at least.

Building	Work number	
	Date	Checked
Designer	Content	
	Floor between dwellings (sanitary rooms)	

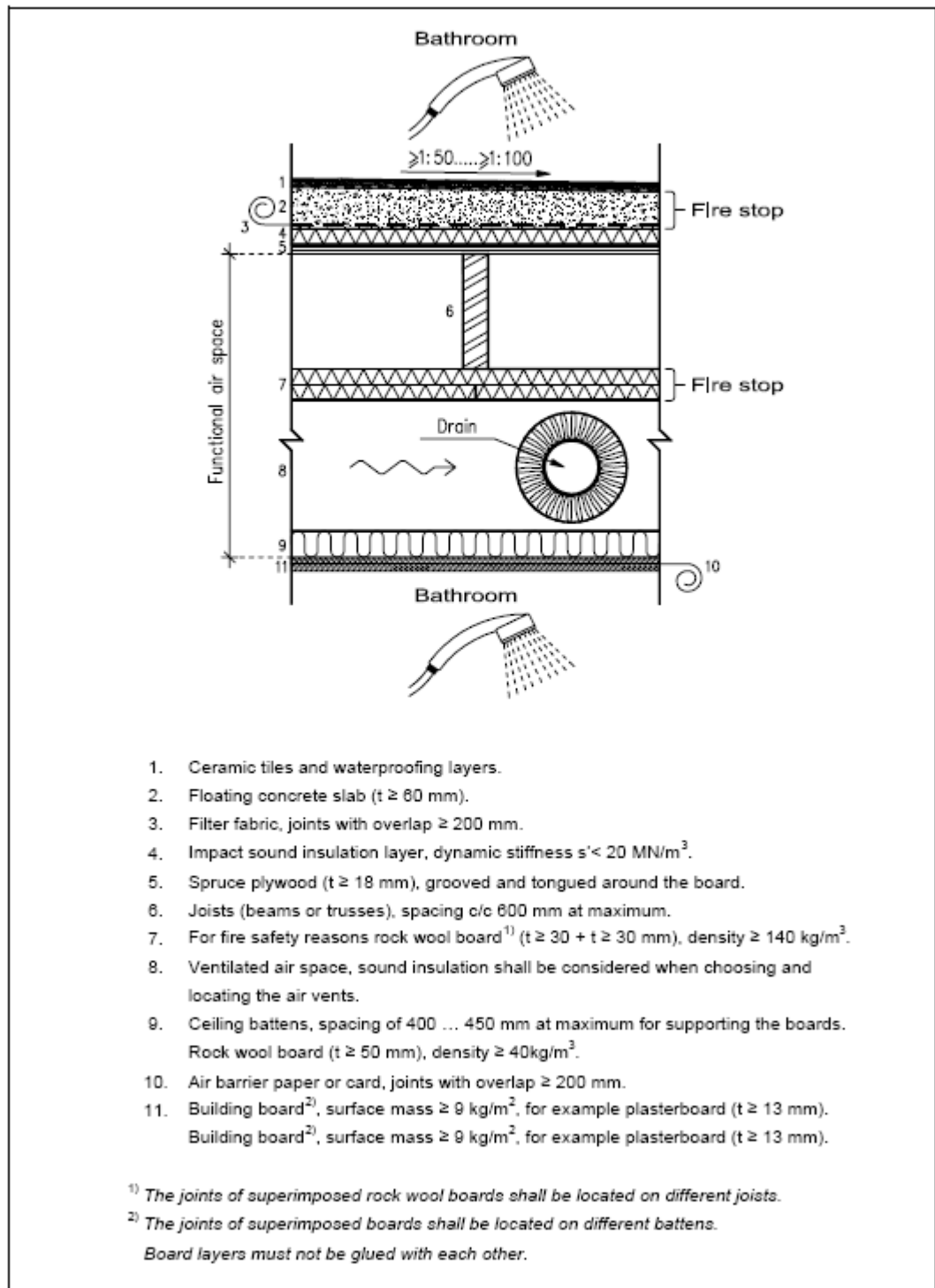

FIG 115 Floor /2/

Building	Work number	
	Date	Checked
Designer	Content	
	Double frame wall / Plinth	

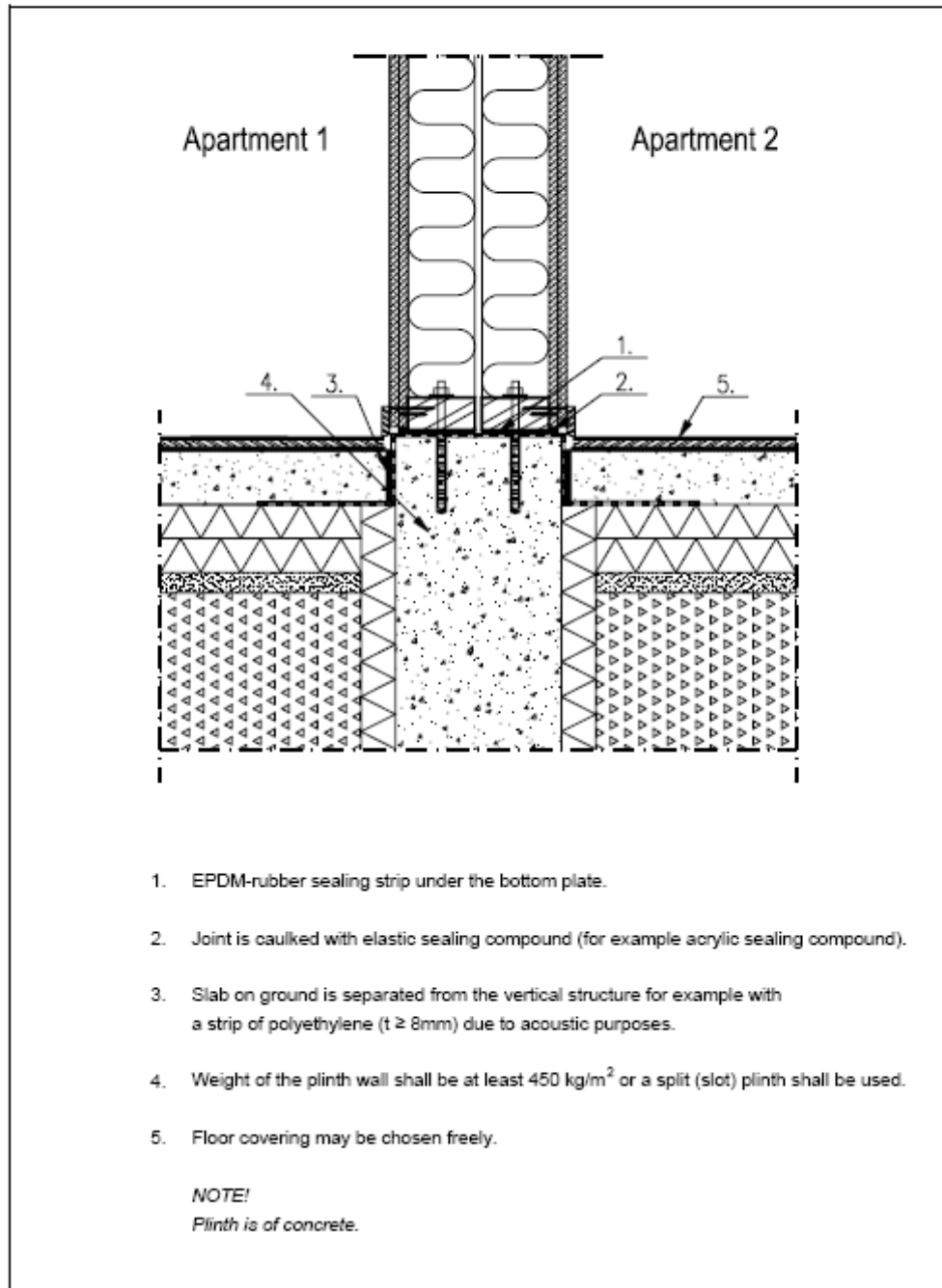

FIG 116 Floor /2/

TABLE /2/

Airborne sound insulation between dwellings						May 2004
Main requirements in 24 European countries 2004						
Country with indication of concept for formulation of requirements		Multi-storey housing		Terraced housing		
		Req. [dB]	Eq. R'_{w} ^{(1), (2)} [dB]	Req. [dB]	Eq. R'_{w} ^{(1), (2)} [dB]	
Denmark	R'_{w}	$\geq 52^{(3)}$	52 ⁽³⁾	≥ 55	55	
Norway	R'_{w} ⁽⁴⁾	$\geq 55^{(4)}$	55 ⁽⁴⁾	$\geq 55^{(4)}$	55 ⁽⁴⁾	
Sweden	$R'_{w} + C_{50-3150}$	≥ 53	$\sim 55^{(7)}$	≥ 53	$\sim 55^{(7)}$	
Finland	R'_{w}	≥ 55	55	≥ 55	55	
Iceland	R'_{w} ⁽²⁾	$\geq 52^{(4)}$	$\sim 52^{(4)}$	≥ 55	~ 55	
Germany	R'_{w}	$\geq 53^{(5)}$	53	≥ 57	57	
UK	$D_{nf,w} + C_{tr}$	≥ 45	$\sim 49-52^{(7)}$	≥ 45	$\sim 49-52^{(7)}$	
France	$D_{nf,w} + C$	≥ 53	$\sim 53-56$	≥ 53	$\sim 53-56$	
Switzerland	$D_{nf,w} + C$	≥ 54	$\sim 54-57$	≥ 54	$\sim 54-57$	
Austria	$D_{nf,w}$	≥ 55	$\sim 54-57$	≥ 60	$\sim 59-62$	
Netherlands	$I_{L_{nk}}$	≥ 0	~ 55	≥ 0	~ 55	
Belgium ⁽⁹⁾	$D_{nf,w}$	≥ 54	$\sim 53-56$	≥ 58	$\sim 57-60$	
Italy	R'_{w}	≥ 50	50	≥ 50	50	
Spain ⁽⁹⁾	$D_{nf,w} + C_{100-5000}$	≥ 50	$\sim 50-53$	≥ 50	$\sim 50-53$	
Portugal	$D_{n,w}$	≥ 50	$\sim 50-52$	≥ 50	$\sim 50-52$	
Poland	$R'_{w} + C$	$\geq 50^{(8)}$	~ 51	≥ 52	~ 53	
Czech Rep.	R'_{w}	≥ 52	52	≥ 57	57	
Slovakia	R'_{w}	≥ 52	52	≥ 52	52	
Hungary	R'_{w}	≥ 52	52	≥ 57	57	
Slovenia	R'_{w}	≥ 52	52	≥ 52	52	
Estonia	R'_{w}	≥ 55	55	≥ 55	55	
Latvia	R'_{w}	≥ 54	54	≥ 54	54	
Lithuania	$D_{nf,w}$ or R'_{w}	≥ 55	~ 55	≥ 55	~ 55	
Russia	I_b	≥ 50	52	⁽⁴⁾	⁽⁸⁾	

Notes

⁽¹⁾ Warning: The equivalent values are rough estimates only as no exact conversion is possible.

⁽²⁾ The equivalent minimum values of R'_{w} are - except the conversions of $I_{L_{nk}}$ and I_b - estimated applying the guidelines in [11] and the C data in [12].

⁽³⁾ The maximum unfavourable deviation from the reference curve shall be limited to 8 dB.

⁽⁴⁾ 55 dB recommended.

⁽⁵⁾ Horizontal, requirement for vertical is 1 dB higher.

⁽⁶⁾ It is recommended that the same criteria are fulfilled by $R'_{w} + C_{50-3150}$.

⁽⁷⁾ Assuming heavy constructions, stricter requirement for lightweight constructions.

⁽⁸⁾ No requirements. Probably the requirements for multi-storey housing are used.

⁽⁹⁾ Proposed new requirements.

TABLE

Impact sound insulation between dwellings					May 2004
Main requirements in 24 European countries 2004					
Country with indication of concept for formulation of requirements		Multi-storey housing		Terraced housing	
		Req. [dB]	Eq. $L'_{n,w}$ ^{(1), (2)} [dB]	Req. [dB]	Eq. $L'_{n,w}$ ^{(1), (2)} [dB]
Denmark	$L'_{n,w}$	≤ 58	58	≤ 53	53
Norway	$L'_{n,w}$ ⁽³⁾	≤ 53 ⁽³⁾	53 ⁽³⁾	≤ 53 ⁽³⁾	53 ⁽³⁾
Sweden	$L'_{n,w} + C_{1,60-2500}$	≤ 56 ⁽⁴⁾	~ 56 ⁽⁴⁾	≤ 56 ⁽⁴⁾	~ 56 ⁽⁴⁾
Finland	$L'_{n,w}$	≤ 53	53	≤ 53	53
Iceland	$L'_{n,w}$ ⁽³⁾	≤ 58 ⁽³⁾	58 ⁽³⁾	≤ 53	53
Germany	$L'_{n,w}$	≤ 53	53	≤ 48	48
UK	$L'_{n,w}$	≤ 62	~ 64-57	None	N/A
France	$L'_{n,w}$	≤ 58	~ 60-53	≤ 58	~ 60-53
Switzerland	$L'_{n,w} + C_1$	≤ 50	~ 52-45 ⁽⁴⁾	≤ 50	~ 52-45 ⁽⁴⁾
Austria	$L'_{n,w}$	≤ 48	~ 50-43	≤ 46	~ 48-41
Netherlands	I_{co}	≥ +5	~ 61-54	≥ +5	~ 61-54
Belgium ⁽⁵⁾	$L'_{n,w}$	≤ 58	~ 60-53	≤ 50	~ 52-45
Italy	$L'_{n,w}$	≤ 63	63	≤ 63	63
Spain ⁽⁶⁾	$L'_{n,w}$	≤ 65	~ 67-60	≤ 65	~ 67-60
Portugal	$L'_{n,w}$	≤ 60	60	≤ 60	60
Poland	$L'_{n,w}$	≤ 58	58	≤ 53	53
Czech Rep.	$L'_{n,w}$	≤ 58	58	≤ 53	53
Slovakia	$L'_{n,w}$	≤ 58	58	≤ 58	58
Hungary	$L'_{n,w}$	≤ 55	55	≤ 47	47
Slovenia	$L'_{n,w}$	≤ 58	58	≤ 58	58
Estonia	$L'_{n,w}$	≤ 53	53	≤ 53	53
Latvia	$L'_{n,w}$	≤ 54	54	≤ 54	54
Lithuania	$L'_{n,w}$	≤ 53	53	≤ 53	53
Russia	I_y	≤ 67	60	⁽⁷⁾	⁽⁷⁾

Notes

⁽¹⁾ Warning: The equivalent values are rough estimates only as no exact conversion is possible.

⁽²⁾ The equivalent maximum values of $L'_{n,w}$ are - except the conversions of I_{co} and I_y - estimated applying the guidelines in [11] and C data in [12].

⁽³⁾ It is recommended that the same criteria are fulfilled by $L'_{n,w} + C_{1,60-2500}$.

⁽⁴⁾ The same criteria shall also be fulfilled by $L'_{n,w}$.

⁽⁵⁾ 53 dB recommended.

⁽⁶⁾ Assuming heavy constructions, stricter requirement for light-weight constructions.

⁽⁷⁾ No requirements. Probably the requirements for multi-storey housing are used.

⁽⁸⁾ Proposed new requirements.

3.4 Moisture

/21/

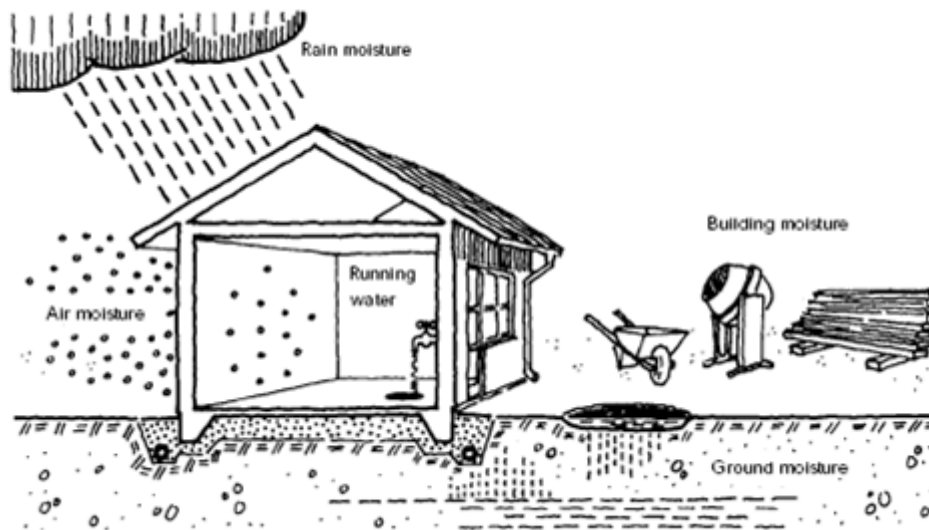

FIG 117 Moisture /21/

Part of a building may be subject to moisture through precipitation, condensation of water vapour in the air, absorption of ground moisture or leakage. Furthermore, all materials come into contact with the water vapour in the air and absorb a certain amount of water. During the time of building, the construction may also be subject to great amounts of water, known as building moisture.

Normally, the main sources of moisture are:

- air moisture
- building moisture
- rain moisture
- ground moisture (vapour content of 100 %)
- running water

Air moisture

Air contains water vapour and the content level is denoted by RH. The relative humidity level outdoors may be assumed to 85 % during the winter and 70 % during the summer. The relative humidity level of the air inside the house is determined by the outside air temperature and the vapour content, the inside air temperature, production of moisture inside the house in addition to the ventilation intensity below the stationary circumstances. That is to say, if there is an even production of moisture and level ventilation intensity, the correlation may be written as vapour content inside the house = vapour content outside the house + the moisture contribution. The full value of this moisture contribution during the winter months may be; 3 g/m³ for the office and 4 g/m³ for the normal dwellings. /21/

Building moisture

Building moisture is moisture to which constructions are subjected during the building stage or during the manufacturing of the building materials. After the building phase, building

moisture should dry out in order that the construction comes into equilibrium with the surrounding relative vapour content. /21/

Ground moisture

The influence of ground moisture is largely dependant on the level of the ground water, but also the type of land, the ground level, the cause of the water and the ground's drainage properties. Ground moisture may be divided into the following categories:

- Surface water
- Infiltration water (i.e. surface water penetrating into construction)
- Ground water
- Fracture water
- Capillary absorbed water

Above the highest surface of the ground water (HSGW), the ground moisture should always be assumed as 100 % RH. /21/

Moisture transport

The most important moisture transport mechanisms are:

- Diffusion
- Convection (as water vapour)
- Capillary absorption
- Force of gravity (as liquid)

Diffusion

Moisture diffusion strives to level out the differences in vapour content in the air through molecule movements. The moisture flows from an area with higher vapour content to an area with lower vapour content. Diffusion may in practice be regarded nondependent of the temperature.

TABLE /21/

Temperature (°C)	Saturation vapour content ρ_m (10^{-2} kg/m ³)	Saturation vapour pressure	
		P_m (Pa)	(mmHg)
-12	1.81	217.3	1.63
-10	2.15	259.9	1.95
-8	2.54	309.3	2.32
-6	3.00	367.9	2.76
-4	3.53	437.2	3.28
-2	4.15	517.2	3.88
0	4.86	610.5	4.58
1	5.18	657.2	4.93
2	5.57	705.2	5.29
3	5.96	758.2	5.69
4	6.37	813.1	6.10
5	6.79	871.8	6.54
6	7.26	934.4	7.01
7	7.74	1001.0	7.51
8	8.27	1073	8.05
9	8.83	1148	8.61
10	9.40	1228	9.21
11	10.03	1312	9.84
12	10.67	1402	10.52
13	11.38	1494	11.23
14	12.05	1598	11.99
15	12.83	1705	12.74
16	13.66	1817	13.63
17	14.45	1937	14.53
18	15.36	2063	15.48
19	16.29	2197	16.48
20	17.3	2338	17.54
21	18.3	2486	18.65
22	19.4	2643	19.83
23	20.6	2809	21.07
24	21.8	2983	22.38
25	23.0	3167	23.76
26	24.4	3360	25.21
27	25.8	3564	26.74
28	27.2	3779	28.35
29	28.7	4004	30.04
30	30.4	4242	31.82

Capillary suction

Capillary suction attempts to level out the moisture content in a material through moisture travel in the fluid phase. Capillary suction may normally be neglected on dry material but if certain critical moisture content is found, there will be a continuous water mass in the material and moisture transport through capillary suction will be significant. This type of capillary water transport rarely needs to be taken into consideration. However it occurs around insulation on the ground and by oncoming pelting rain. /21/

Air tight housing

This applies to efficient building insulation in order to save energy. Simultaneously, the building has to be constructed air tight in order for the ventilation to be controllable. A good air tightness means that the air is transmitted to all the largest parts via the ventilation system. The ventilation amount may be adjusted to the requirements of the building irrespective of wind pressure and similar. /21/

Cellar walls

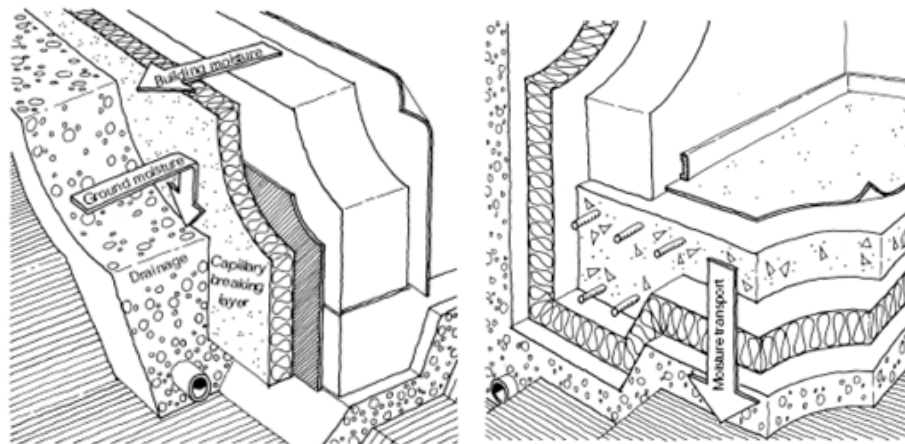

FIG 118 Moisture /21/

Cellar walls are susceptible to different sources of damp. In the cellar walls there is building moisture, gaps within the walls contain air moisture and in the ground outside the wall, there is ground moisture. Furthermore, the area may be subjected to obtaining local water pressure against the wall as a result of rain, melted water or water currents in the ground. Moisture may also be absorbed via capillary action through the lower plate in walls. Therefore, damp in cellar constructions must be dried out. The design engineer has to presuppose that one is able to provide the interior with dense material for example, vinyl tape or tight acrylic paint. The scientific way is to prevent the moisture problem in cellar walls thus making it possible for the construction to dry out from the outside. If the cellar wall is insulated from the outside with a capillary breaking, vapour permeable material must the outside forthcoming moisture be diverted. Building moisture may dry out through the vapour permeable insulation. This means that it does the same irrespective of the material on the inner jacket. It is also advised to have a taut coating on the inner jacket as well.

Slab on the ground and cellar floors

Slab on the ground floor and cellar floors may be insulated above and below concrete. Many complaints in recent years have focused on the moisture problem of the slab on the ground foundations. Most cases refer to wood framed flooring above the concrete slab. Therefore, this construction solution is applied to hardly any constructions today. /21/

Insulation below concrete

The best and safest way to build a slab on the ground floor is to insulate the under side of it with open insulation. This type of thermal insulation incorporates a moisture mechanical advantage and allows moisture transport from the slab to the ground instead of from the ground to the slab. Insulation must be laid under the entire floor. /21/

Frost

The more fine-grained the area of land, the thicker the water holes resulting in the individual grain of earth will be. This means that the water molecules may be transported easier and even quicker when the grain of earth is small and the transport route short. In a fine-grained area of land however, the frost elevation will be easier since the number of contact points between the ice sheets and the amount of grains is significantly greater (the load at each point is smaller). Clay is an exception since it has a low capillary path speed. /21/

Insulation in the ground prevents frost damage

Frost damage may be prevented in different ways. You can:

- Change the frost prone area of land for one less prone to frost
- Lower the ground water level in order that the earth cannot absorb water
- Foundations for frost free depth
- Lay a layer of thermal insulation in the ground

From an economical point of view, the most interesting alternative is to position a thermally insulated layer. The advantage with ground insulation is that the thermal current can be limited from the ground during insulation. As a result there is less frost depth since the temperature beneath the insulation layer seldom falls short of 0 °C. /21/

Ground insulation

There are many different recommendations for insulation materials that are to be used in the ground and for structures on the ground. The old tradition of observing natural geography is unfortunately not always followed. The various ground insulation solutions are more or less resistant to moisture load. The functioning of the various materials and the major differences are presented below. /21/

Ground Slab

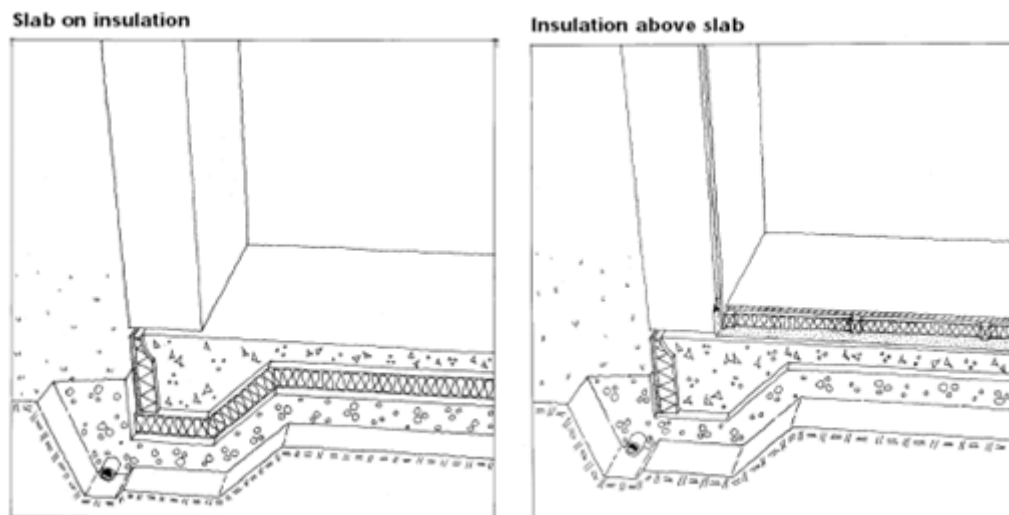

FIG 119 Moisture /21/

A ground slab supporting a heated building must always be provided with heat insulation. Its main purpose is to limit relative humidity in the floor to a level that does not damage the flooring material. The insulation shall also reduce heat losses along outer parts of the floor. If the insulation of the slab is very thick, ground frost insulation may be necessary on the outside.

Basement wall

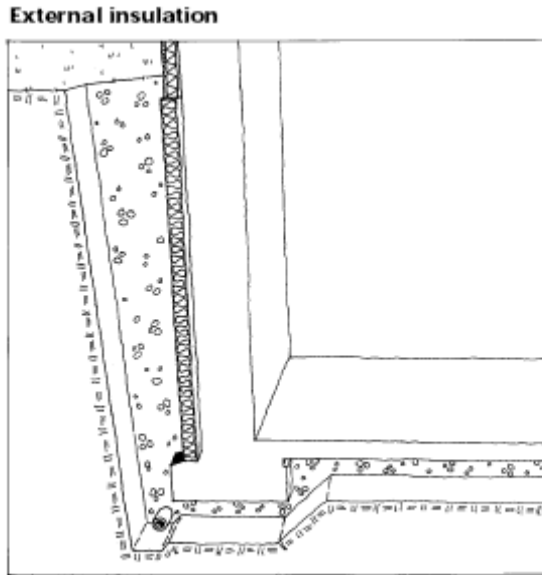

FIG 120 Moisture /21/

The basement is subject to various sources of moisture. The wall structure contains moisture that must be allowed to dry out. There is moisture from the ground outside the basement wall. Rain, water from melting snow and ice or water currents in the ground can also cause local water pressure against the basement wall. Capillary action can cause water to be sucked through the slab and up the wall.

Insulation theory

/21/

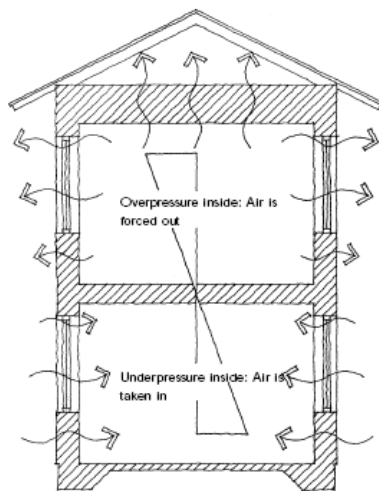

Figure 6

FIG 121 Insulation /21/

When planning, it is important that the house is looked at in its entirety and not just by the performance of the individual components. Even if the calculation of the heat losses has been

carried out correctly in theory, there is no guarantee that the result will agree with the actual outcome. Construction must be carried out in a professional way. This means that the work must be performed both correctly and accurately. It is important that these four principles are followed when construction is carried out, otherwise there will be a risk of unnecessarily high energy consumption and in the worst case damp damage may result.

Air and vapour barriers

A modern house must be airtight in order for the ventilation to function as intended. Therefore, an air and vapour barrier is required, this will operate during the entirety of the lifetime of the house. Normally a plastic sheeting is built into the structure, which is placed on the “warm side” of the insulation. Other materials, such as concrete, can provide airtightness. /21/

Installation of insulation

Thermal insulation must fill up the whole of its space. There must be no air gaps. It is particularly important to avoid air gaps on the “warm” side of the insulation. If the insulation does not fill up the whole of its space, air can begin to circulate, a convection that can seriously decrease the intended insulation efficiency. /21/

Wind protection

When the air moves behind the facade, it is important that it cannot penetrate the primary insulation or the gaps around the insulation. Therefore, there must be wind protection in place to prevent this. The wind protection must be adapted to the insulation material, the facade material and the entire structure. /21/

Ventilated air space

There should normally be an air space that is ventilated by outdoor air behind a facade layer or under a large number of roof coverings. The air space allows the moisture that comes in from the outside to be ventilated away. It also functions as an extra safety device if any part of the inside of the structure has not been made airtight. Certain structures with totally airtight exteriors – e.g. warm roofs and sandwich structures – do not require an air space. If the material and the construction are both perfect, there will be a certain safety margin in relation to the calculated value. But any errors in the execution of the work or faults in the finished structure can affect both the insulating efficiency and durability.

A correctly functioning air and vapour barrier is particularly important when there is too much pressure indoors. This occurs nearly always at the top of the building during the winter. If the attic joist floor is not airtight, heat and damp air can penetrate their way into the structure and condense. The consequences can be serious mould damage. In addition, if the insulation is not kept dry, its insulating properties will be reduced. Moisture convection, moisture that accompanies air when it penetrates into a structural component, is much more dangerous than moisture diffusion, that is moisture which is transferred due to differences in vapour content. Airtightness is therefore very important. But the barrier should also prevent vapour diffusion into the structure.

Otherwise water vapour can condense and cause damage. The driving force for diffusion is highest during the winter since moisture will flow into the building from people and from activities. The barrier must then be placed on the inside in order to be effective. If it is placed on the outside, it will have almost the opposite effect to that intended. In this case the moisture will condense on the barrier. It is sometimes stated that a vapour barrier on the inside can cause damage during warm, rainy summer days when the diffusion drives the moisture from the outside to the inside of the structure. However a large number of investigations show that

these fears are exaggerated. It is the driving forces during the winter that must be guarded against. The air and vapour barrier is usually a 0.2 mm PE foil that satisfies national standards for ageing resistance. Joints must be kept to a minimum and be as well sealed as possible. /21/

Wind protection

The wind protection must prevent air that moves behind a façade or an external wall from ruining the thermal insulation capabilities of the insulation. Therefore the air that moves parallel to the insulation is to be protected against using the wind protection, the air and vapour barrier will deal with air movement through the structure. The requirement for wind protection depends on the size of the air movements to be expected behind the façade layer. A well-walled brick façade will provide significantly lower air movements than a wooden panel, for example. /21/

C3 Building Regulations

Thermal insulation in a building

The requirements for thermal insulation may be fulfilled either by directly using the maximum U-values for building components or by indicating with calculations that the heat losses of the building envelope do not exceed the reference level

When a heated or especially warm space abuts to the outdoor air, to an unheated space or to the ground, the thermal transmittances U for building components must not exceed the following values:

wall 0.17 W/m²K

roof, base floor abutting to outside 0.09 W/m²K

base floor abutting to a crawl space (total area of ventilation openings a maximum of 8 per mil of the base floor area) 0.16 W/m²K

building component against the ground 0.16 W/m²K

window, door 1.4 W/m²K

The total window area in the building may be a maximum of 15 % of the gross floor area of the building. However, the proportion of the window area must not exceed 50 % of the total area of outside walls.

If the thermal transmittances for building components do not fulfil the requirements the thermal insulation requirements in a building may be fulfilled by improving heat recovery from exhaust air in respect of the required level in Part D2 of the National Building Code in such a way that the energy use for heating in the actual building is not more than the energy use for heating in a reference building thermally insulated.

Thermal transmittances (U) for building components are calculated using thermal conductivity design values determined for building materials provided with a CE mark in accordance with the EN standards; tabulated design values for thermal conductivity stated in the EU standards; values of normative thermal conductivity (λ_n) or any other thermal conductivity design values suitable for the building component and determined in an acceptable way. If the same material is provided with several λ_n -values, the value suitable for the target on the basis of footnotes is selected.

U-value

2.2.3 Structural layer even and homogeneous

Interior surface thermal resistance					$R_{si} := 0.13$
gypsum board	$\lambda_1 := 0.25$	$d_1 := 0.01$	$R_1 := \frac{d_1}{\lambda_1}$		$R_1 = 0.057$
moisture barrier					$R_2 := 0.03$
glass wool	$\lambda_3 := 0.04$	$d_3 := 0.1$	$R_3 := \frac{d_3}{\lambda_3}$		$R_3 = 4.878$
wind barrier wooden fibre board	$\lambda_4 := 0.07$	$d_4 := 0.02$	$R_4 := \frac{d_4}{\lambda_4}$		$R_4 = 0.357$
Exterior surface thermal resistance					$R_{se} := 0.13$
	$R_T := R_{si} + R_1 + R_2 + R_3 + R_4 + R_{se}$				$R_T = 5.572$
	$U_1 := \frac{1}{(R_{si} + R_1 + R_2 + R_3 + R_4 + R_{se})}$				$U_1 = 0.179$

2.2.4 Building component including unhomogeneous structural layers
= vertical stud 50x200 mm when thermal conductivities differ < 5 x

vertical stud	$\lambda_5 := 0.1$	$d_5 := 0.1$			
	$f_a := \frac{5}{60}$		$R_{aj} := \frac{d_5}{\lambda_5}$		
glass wool	$\lambda_3 := 0.04$	$d_3 := 0.1$			
	$f_b := \frac{55}{60}$		$R_{bj} := \frac{d_3}{\lambda_3}$		

2.2.4 different part areas

$$R_j := \left[\frac{1}{\left(\frac{f_a}{R_{aj}} \right) + \left(\frac{f_b}{R_{bj}} \right)} \right] \quad R_j = 4.203$$

$$R_T := R_{si} + R_1 + R_2 + R_j + R_4 + R_{se} \quad R_T = 4.897$$

$$U_2 := \frac{1}{R_T} \quad U_2 = 0.204$$

E1 Building Regulations

3.5 Fire safety of buildings

The fire classes of buildings are P1, P2 and P3.

Different parts of a building may belong to different fire classes provided that the spread of fire is prevented by a fire wall. Exits from the parts of a building separated by a fire wall shall be constructed as separate exits so that a possible door in the fire wall does not need to be used in case of fire.

The restrictions on the size of buildings are set out in Table 3.2.1. Larger maximum gross floor areas than the figures given in the Table may be accepted if an automatic fire alarm installation, an automatic smoke extraction installation or an automatic fire-extinguishing system is installed in the building.

Buildings shall in general be separated into fire compartments in order to limit the spread of fire and smoke, to provide safe egress, to facilitate rescue and extinguishing operations and to limit property losses. The individual storeys of a building, basement storeys and the attic shall in general be set up as separate fire compartments (fire-separation by storey). The size of a fire compartment shall be limited in such a manner that a fire starting in a compartment will not cause unreasonably vast damages to property (fire-separation by area). Premises with essentially different uses, or with essentially different fire loads, shall be set up as separate fire compartments, if this is necessary for the protection of people or property (fire-separation by use).

A building and the building elements therein must not cause danger through collapse due to the effect of fire within a specified period of time after the start of fire. If a load-bearing building element is required to have a longer fire resistance time with respect to integrity E and insulation I than with respect to load-bearing capacity R, the longer fire resistance time will also be applied to the load-bearing capacity. The class requirements for the load-bearing capacity of constructions are set out in Table 6.2.1.

Fire-separating building elements together with any attached installations and equipment shall be built in such a manner that the spread of fire from one fire compartment to another is prevented for a specified period of time.

The fire resistance time of a door, window and other building element covering relatively small openings in a fire-separating building element shall in general be at least half of the fire resistance time required for the fire-separating element.

When assessing the fire-technical characteristics of walls, ceilings and floors, the contribution of the materials to the fire, the time to flashover, the release of heat and the production of smoke and flaming droplets is considered.

It must be possible to evacuate a building safely in case of fire or other emergency. A building shall be provided with an adequate number of appropriately located exits which are sufficiently spacious and easily passable, so that the time to evacuate the building will not be so long as to cause danger.

G1 Regulations and Guidelines

3.6 Housing Design

The size and shape of a habitable room should be appropriate taking into account the intended use of the room and its furnishability. However, the minimum net room area of a habitable room should always be 7 m². A space lower than 1600 mm is not included in the net room area. The minimum room height of a habitable room should be 2500 mm. The said minimum height in a one-family house is 2400 mm. The room height of a small part in a habitable room may be even less than that referred to previously, however, not below 2200 mm. A habitable room should have a window with an opening of at least 1/10 of the net room area.

The minimum distance to the opposite building in front of the main window of a habitable room in the same or neighbouring property should be equal to the height of the opposite building measured from the floor level of a room unless otherwise provided by the town plan. However, there should be up to a distance of at least 8 metres of unbuilt space in front of the main window.

The floor of a habitable room should be above the ground where the wall with the main window is. However, some of the habitable rooms in an apartment may be, in the said respect, located below the ground to a minor extent.

The minimum net floor area of an apartment should be 20 m².

The facilities and the floor plan of an apartment should be appropriate in respect of the living environment taking into account the intended occupancy, circulation areas in dwellings and the changes in operational needs. Apartments should have enough space for resting, pastime and leisure activities, eating and cooking, bathing as well as for any necessary maintenance and storage connected with living. There should be appropriate facilities for clothes maintenance and storage of personal property as well as for storage of bicycles, prams and outdoor recreational equipment in apartments or for the use of the apartments.

The minimum clear width of doors and passages, leading from a front door of an apartment to habitable rooms and to any other necessary facilities used for living, should be 900 mm. The same applies to doors and passages leading to any necessary facilities in a building and garden area used for living.

The minimum floor height in a multi-storey block is 3000 mm. In multi-storey blocks where the access to apartments is on the third floor or higher including the entrance storey level, the stair route to apartments must be provided with a lift suitable for users of wheelchairs.

4 Framing

Frame solutions depend on the project; e.g. a single-family house, a multi-storey residential house or a commercial building and on the material; timber, concrete or steel.

4.1 Concrete Block Framing

/5/

The instructions of supporting structures has been presented in B4, B5, B8 and B9 Concrete , Light Concrete, Brick and Block Construction of Finland's building regulation collection . In addition the product information is available.

Fire regulations

The fire safety regulations concerning building have been presented in the part of Finland's building regulation collection, E1 Fire safety. Usually the small houses are in the class P3

Foundations

The height relations of the building place, the moisture technical properties of soil and the bearing properties affect the structure choice and material choice of soles and of foundation walls. Surface waters in terrain and roof waters are conducted away with sufficient inclinations and the functionality of the subsurface drainage is checked. In the low foundation system it should be especially taken into consideration that the floor level also stays sufficiently above the earth's surface. In the bearing base floors a high enough crawl space is left under the floor for the inspections and maintenance. In the cellar solutions it is taken care of the external water proofing of retain walls and for example with ventilating the moisture. Block structures and massive concrete structures have been generally used in the foundations. The upper wall and floor structures are insulated from the foundations.

Walls

The mass can be utilised in as a heat accumulator and heat compensator. In the concrete exterior walls the moisture barrier is not usually used but the air tightness is secured with the surface properties . In the exterior walls the ventilation is secured with vents . The Sandwich-element thermal insulations have ventilation spaces and the seams of the outer covering are equipped with waterpipes. The outer surfaces must be secured for frost and the reinforcement must be stainless. The concrete partitions reach a good moisture proofness, fire resistance and sound insulation . Furthermore, the bearing demands are easily reached.

Floors

Base floors and intermediate floors should be placed so that the floor will be built higher than at least 500 mm the final earth's surface. The ventilation and drainage of the base floors are secured. Typical base floor lies on the compressed gravel. The bearing base floor is equipped with the crawl space.

Roofs

The bearing concrete roof is usually carried out with hollow-core slabs. The thermal insulation is tightly installed over the supporting structure and a sufficient ventilation space is left under the roof.

ULKOSEINÄT RT 82-10438

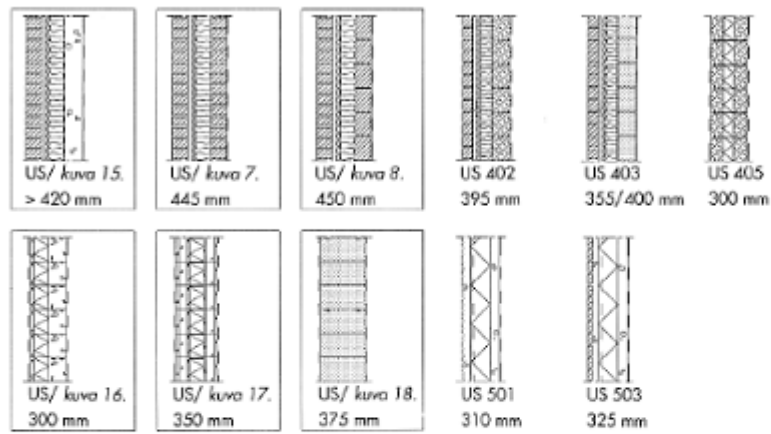

HUONEISTOJEN VÄLISET SEINÄT RT 82-10446

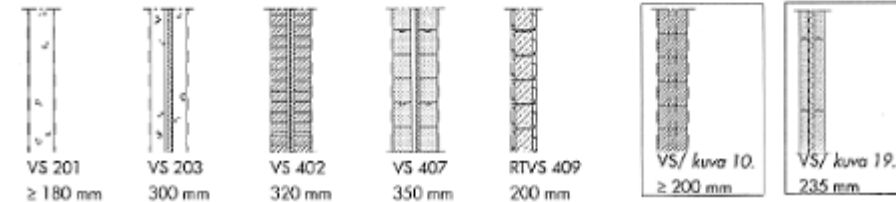

VÄLISEINÄT RT 82-10446

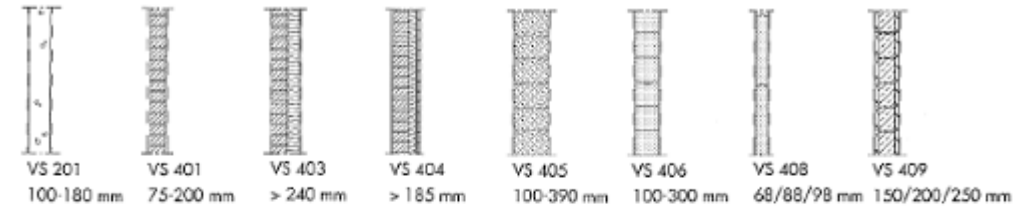

SOKKELI JA SYVÄPERUSTUKSET-R>(KELLARIN ULKOSEINÄ) RT 82-10438

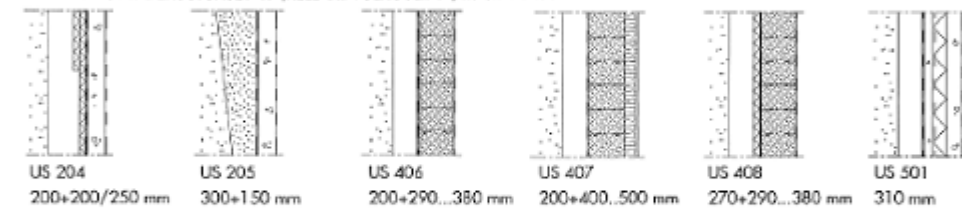

SOKKELI JA MATALAPERUSTUKSET RT 81-10486 JA 81-10524

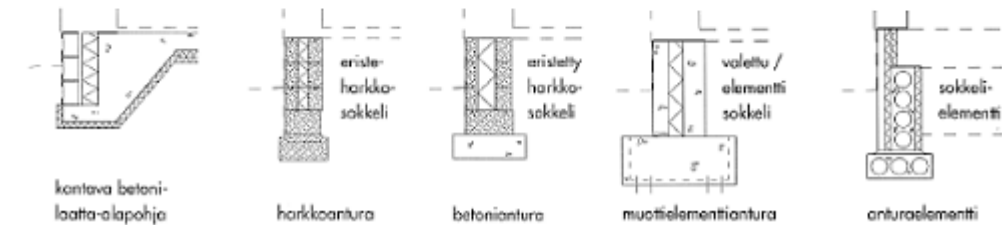
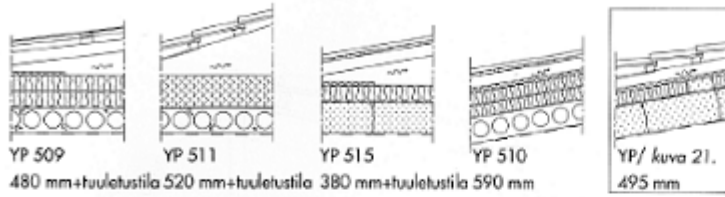

FIG 122 Building Components /5/

Building components described in the table format. Scale 1:50. In the headings it is referred to the information card.

YLÄPOHJAT (KALTEVAT KATOT) RT 83-10449



YLÄPOHJAT (TASAKATOT) RT 83-10449

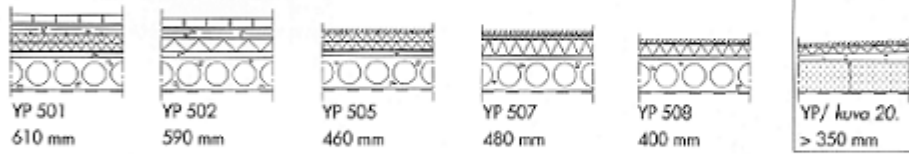

HUONEISTOJEN VÄLISET VÄLIPOHJAT RT 83-10448

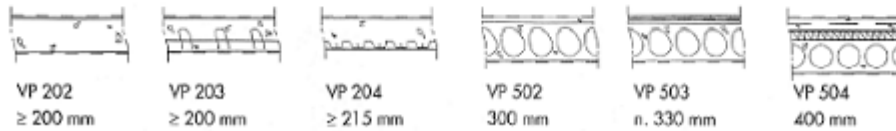

HUONEISTON SISÄISET VÄLIPOHJAT RT 83-10448



KANTAVAT ALAPOHJAT RT 83-10444

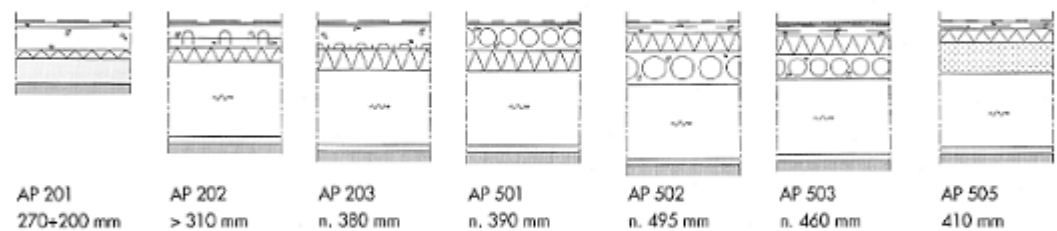

MAANVARAISET ALAPOHJAT RT 83-10444

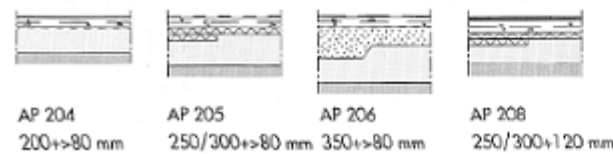

FIG 123 Building Components

Fig Building components described in the table format. Scale 1:50. In the headings it is referred to the information card.

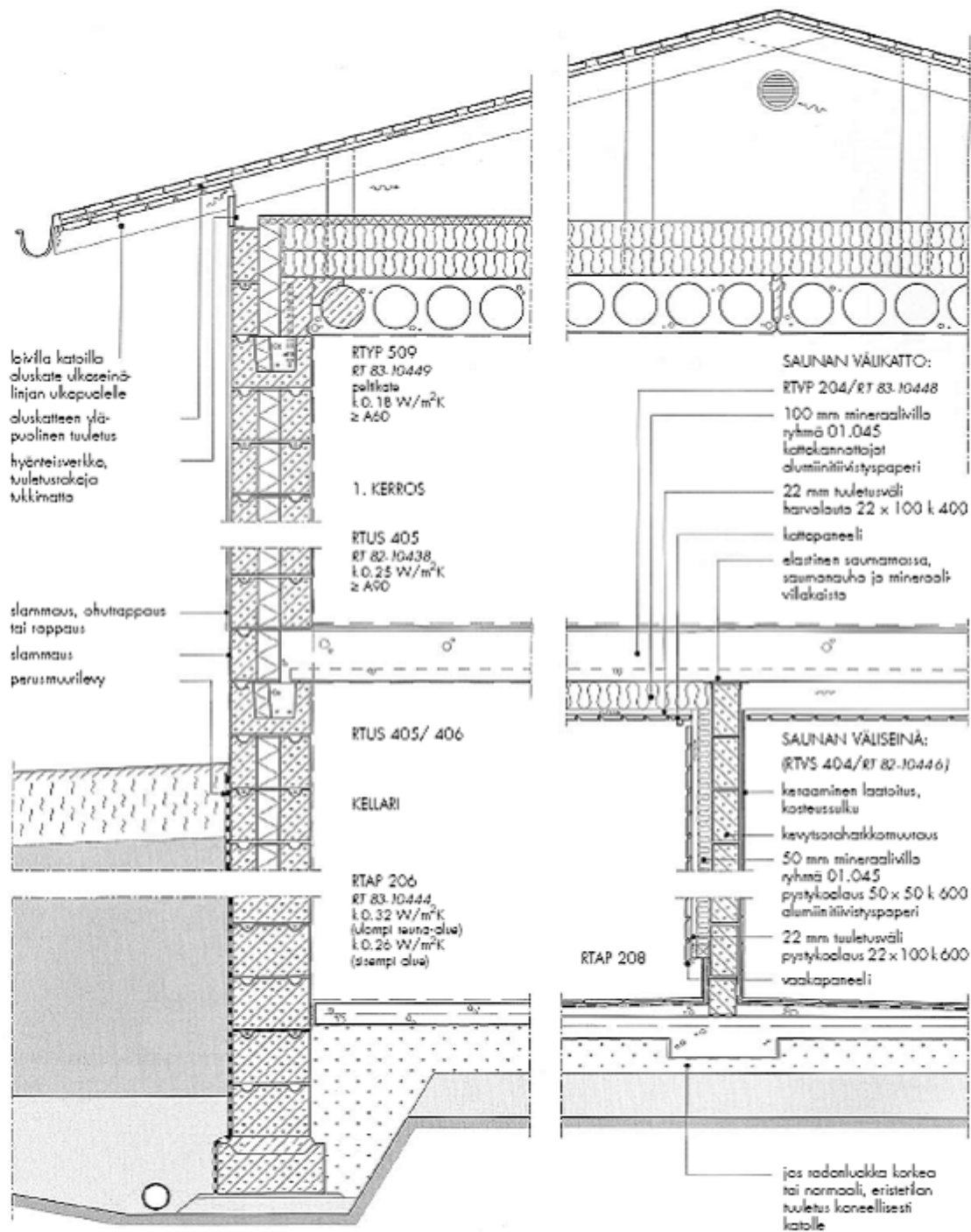

FIG 124 Examples of the structures of the brick house. Longitudinal exterior wall and partition of the sauna, 1:20. /5/

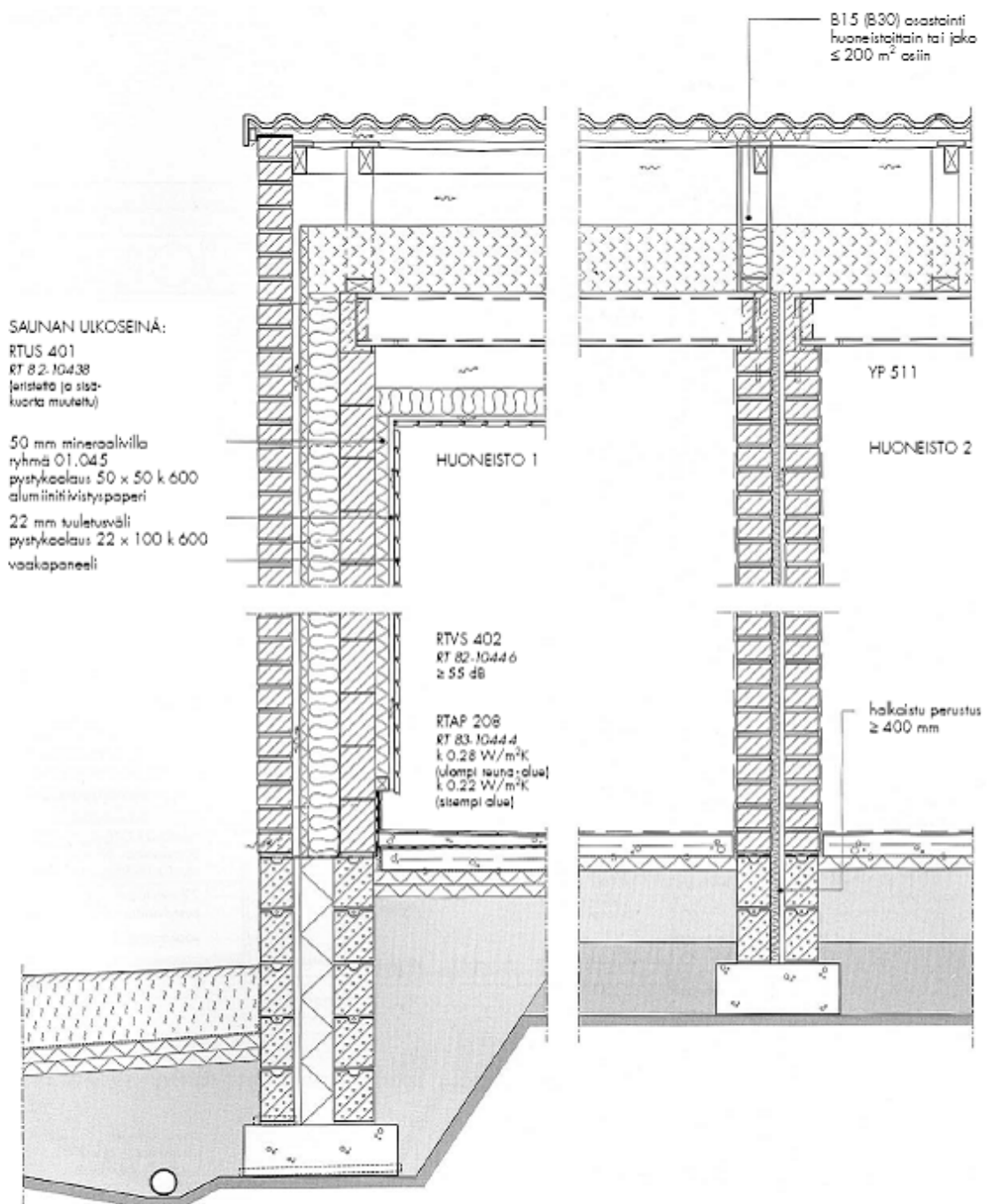

FIG 125 Examples of the structures of the brick house. 1 end up, an exterior wall, sauna state and the partition of flats /5/

5 Concrete Unit Framing

/6/

The concrete unit structures are in Finland generally a multi-storey residential, office-, public, industrial or a warehouse. The element building is quick and advantageous. In the following the principles of the concrete components which are suitable for different building types are explained.

5.1 Residential buildings

Measure system

According to the G1 of the part concerning the housing design of the Building Regulations the minimum storey height of blocks of flats is 3000 mm and the room height is 2500 mm. The residential buildings are designed according to the minimum requirements as a rule in which case one can use to the structure height of the intermediate floor and to the space requirements of the technique no more than 500 mm. This height dimensioning makes wet rooms without a threshold possible.

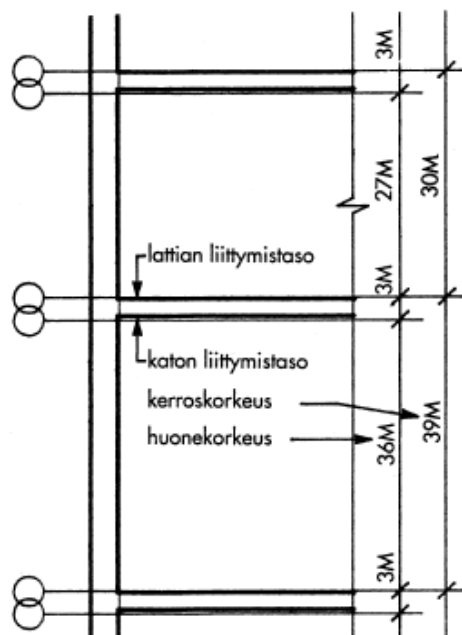

FIG 126 Principles of the vertical measure system of the building frame. /6/

The most suitable bearing structure module net in the practical design is a central module

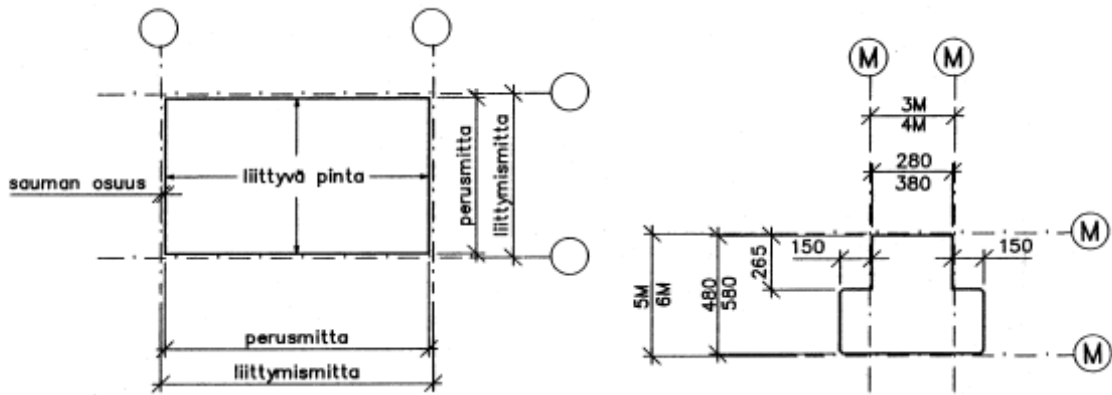

FIG 127 The bearing vertical structures are placed centrally in the module net.. The figure also shows merely the carrying facades as an exception, the module placing of the structure system. /6/

The parallel with the non bearing façade line the module net is placed usually in the inner surface of the inner cover of the sandwich element. The optimal horizontal basic measure of the floor structure 12 M, a smaller module than 6 M is not recommended.

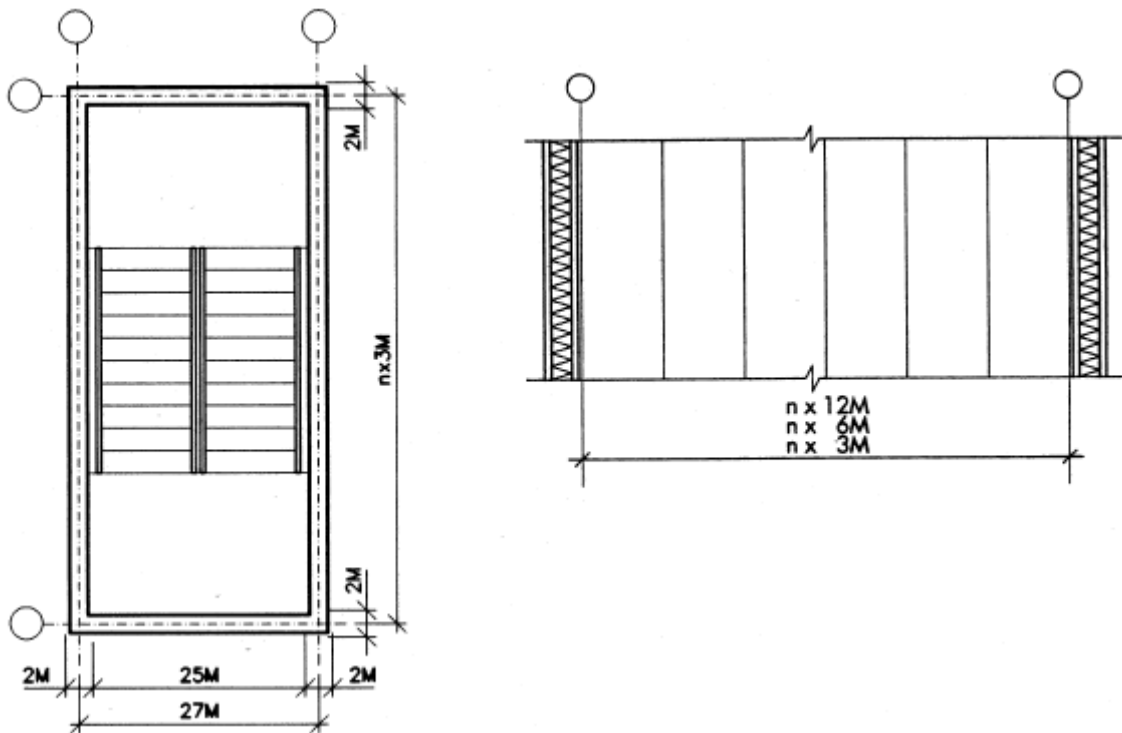

FIG 128 Placing of the module network /6/

The framing system

The blocks of flats are usually made with bearing concrete partition walls and hollow core slabs.

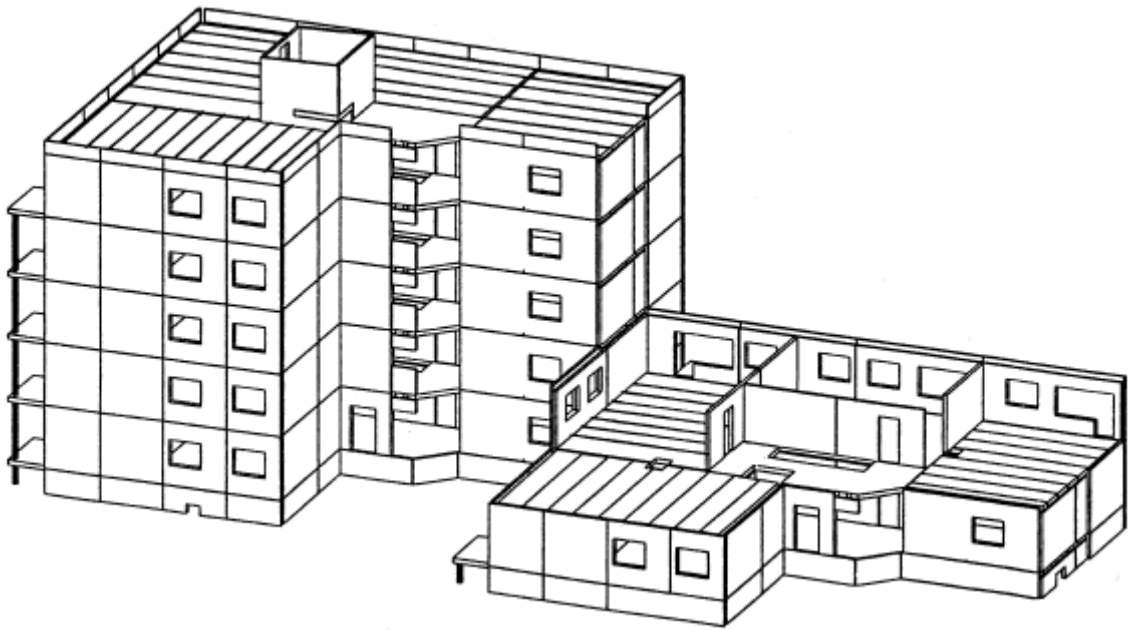

FIG 129 The bearing partition wall-hollow core slab frames /6/

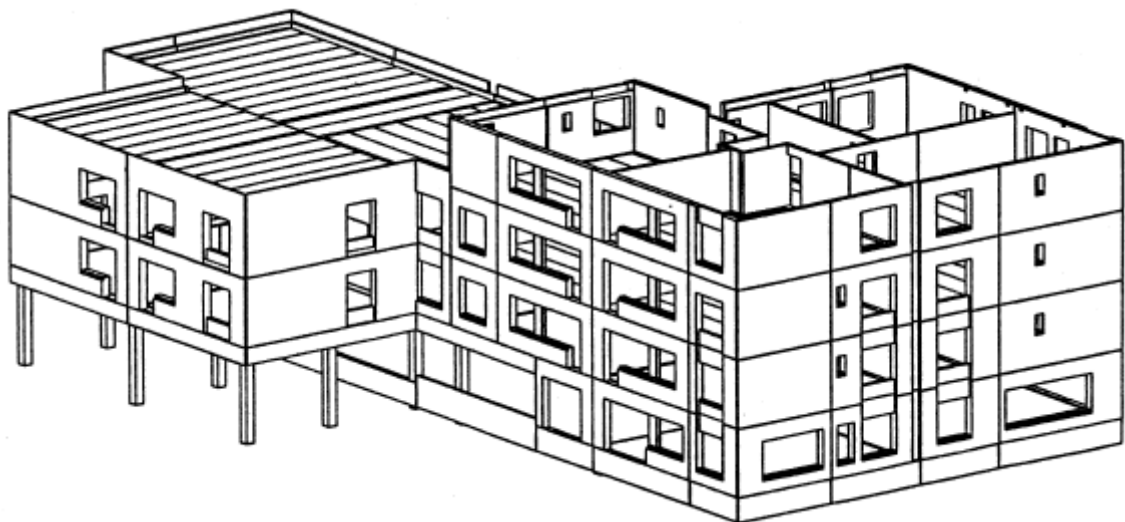

FIG 130 The beam-column frame of the block of flats. /6/

The residential building body is stiffened with concrete walls. The big buildings are divided into parts which are examined as their own entities. There are usually relatively many stiffening walls in the perpendicular direction of the residential building in which case the stiffening does not cause problems. In the longitudinal direction of the residential building the situation is other and the adequacy of the stiffening walls can be a problem. The vertical load of longitudinal walls also are small because the slab elements are parallel with the bearing wall.

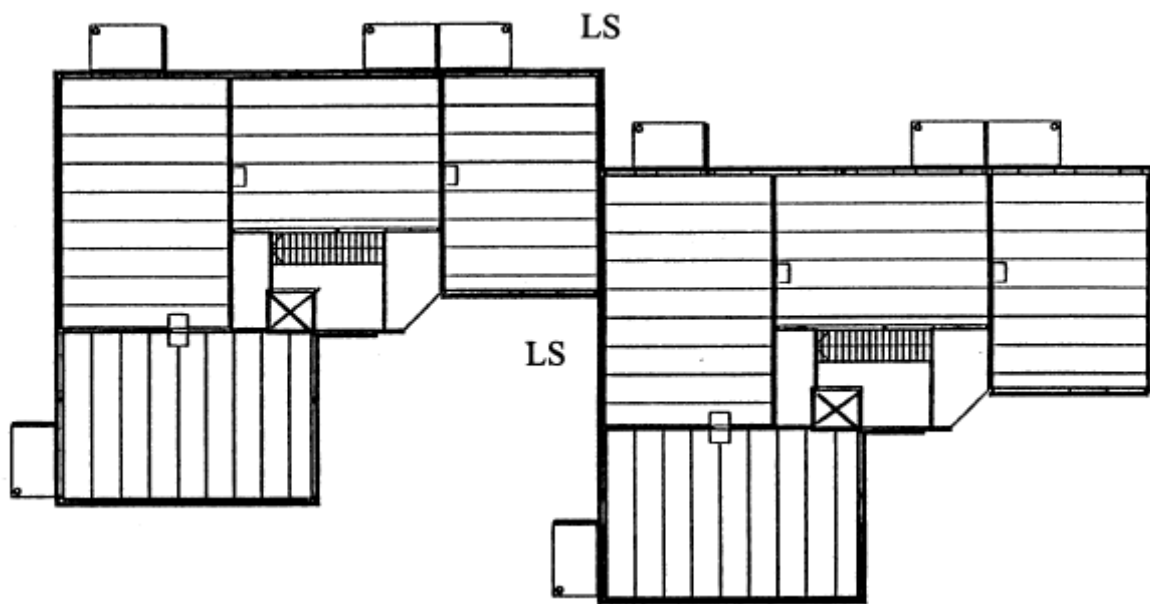

FIG 131 Slab layout of the block of flats. /6/

The slab moves the forces to the vertical structures in the relations of their stiffnesses. The slab is bound with the help of seam rebars and seam castings as a uniform stiff board. The ring reinforcement is dimensioned to resist the force around the slab. The shear forces are moved through the plate seams to the stiffening walls.

Foundations

The bearing walls and columns are placed on the strip foundations. The non-bearing facades are not usually supported on separate pad foundations but they are supported on the foundations of the bearing walls. The size and type of the foundations are determined by the bearing capacity of the soil. The foundation structures of the residential buildings are usually made in situ.

Vertical structures

Concrete partitions and reinforced concrete sandwich external walls are usually used as the bearing frame which carries the residential building. The partitions must fulfill the required sound technical demands. The long spans of the prestressed hollow-core slab make it possible to build big apartments without internal carrying partitions. When only a span exceeds 12 m the internal carrying partitions of apartments will be necessary. The stair elements are normally supported by the concrete partition walls.

The bearing partitions of the residential building are usually 200 mm thick concrete elements. The typical thickness of the bearing exterior wall's inner panel is 150 mm. The hollow-core slabs are directly supported by the walls. When choosing wall thickness, one must check that the support surfaces of slabs are sufficient. The walls are dimensioned into the slender direction as the walls have been supported with hinges. In a stiffer direction the walls serve as the stiffening structures.

Horizontal structures

The horizontal body of the residential building consists of hollow slabs which are supported by the bearing walls. The walls which support parking spaces and business premises can be replaced with concrete columns. The biggest span of cover plates in the residential buildings is 7...8 m and correspondingly that of the hollow-core slabs 11...13 m.

In the blocks of flats the floor slab is usually 265 mm, 320 mm or 370 mm thick hollow-core slab. In wet rooms a lower hollow-core slab or bathroom hollow-core slab which structure height is lower can be used. In that case the water proofing and inclination concrete will not cause a level difference.

When the fire resistance requirement is bigger than R60 a so-called fire slab which has a type approval is used. The base floor is usually either the ground floor slab or a bearing hollow-core slab. The bearing base floor will be used if the bearing capacity of the soil is low or the filling of the base floor would become too high.

The Roof structure is usually made as a low sloped or as a timber pitched roof. The hollow-core slabs can be used also in sloped roofs.

Stair rooms and lift shafts

The walls of stair rooms and of lift shafts are concrete units as a rule. In the stair rooms stair elements are used. The lifts have usually side machines and a separate lift room is not needed.

Facades

The facades of blocks of flats are often made from the bearing or non bearing elements. The elements are the sandwich elements or cover elements. The non bearing facade elements usually bear only their dead load. The use of separate cover elements and differentiated facades gives more alternatives for the facade design. A 240 mm thick mineral fibre wool is usually used as a thermal insulation.

Balconies

The balconies of residential buildings are usually supported with the own external vertical frame of the building which is fastened in the horizontal direction. The joint between a building frame and a balcony structure must be hinged because of the thermal movements. The vertical structures of the balconies must be dimensioned against the crash loads. /6/

5.2 Building Components

AP 205 Concrete slab base floor

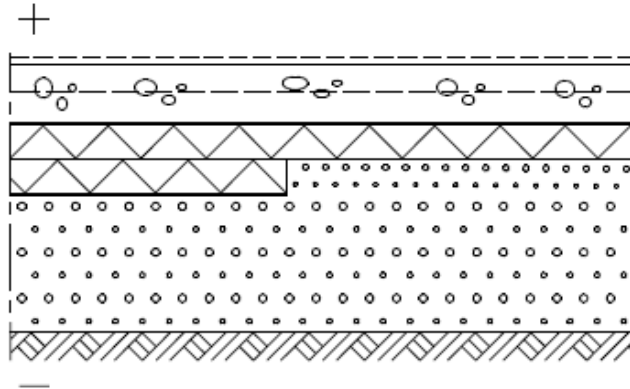

Structure layers:

- Surface material and finish according to room explanation
- Concrete slab BY 31 class A-4-30 reinforcement: mesh 5-150 B500K 80 mm
- Tough paper
- Thermal Insulation, polystyrene (the density 20 kg/m³) $\lambda_n=0.037$ W/mK 150 mm
- The drainage gravel that has been mechanically compressed 200 mm
- The soil gravel, an inclination to the underdrains 1:100

Instructions:

The slab is loosened from the bearing vertical structures and divided into parts with expansion joints according to the structure plan

The surface treatment according to floor material

If the surface material is water vapour tight, the structure moisture of the concrete must be dried away before the installation of the surface material. The maximum humidity according to the instructions of the manufacturer of the surface material

Properties: U-value 0.16 W/m²K

Use area: One-family houses and row of houses , block of flats

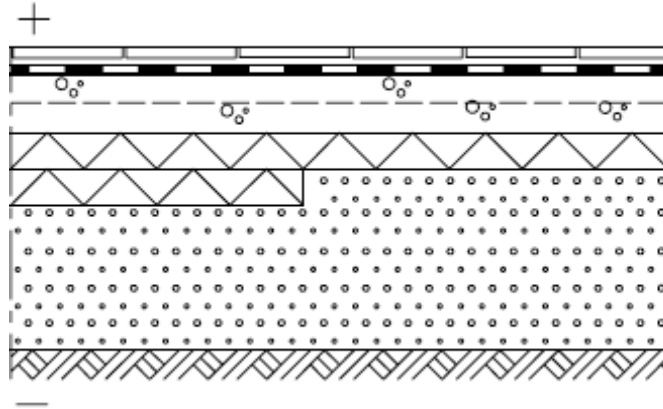
RT AP 208 The base floor of a damp room

Structure layers:

Tiling according to room explanation

- Waterproof fastening plaster
- Waterproof > 1.5 mm
- Concrete slab BY 31 class A-4-30 reinforcement : net 5-150 B500K 80 mm
- Tough paper
- Thermal Insulation, polystyrene (the density 20 kg/m³) $\lambda_n=0.037$ W/mK 150 mm
- The drainage gravel that has been mechanically compressed 200 mm
- The soil gravel , an inclination to the underdrains 1:100

Instructions: The tiling is divided into sectors with elastic seams according to the masterformat

The slab is loosened from the bearing vertical structures and divided into parts with expansion joints according to the structure plan

The surface treatment according to floor material

Properties: U-value 0.16 W/m²K

Use area: One-family houses and row of houses , block of flats

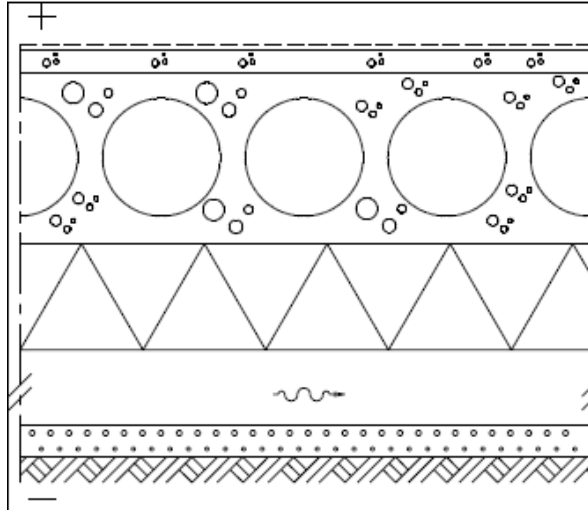
AP 501 The bearing hollow core base floor**Structure layers:**

- Surface material and finish according to room explanation
- Concrete surface BY 31 class A-4-30 >35 mm
- The bearing structure hollow-core slab according to the structural designs
- Thermal Insulation, polystyrene (the density 15 kg/m³) $\lambda_n=0.041$ W/mK fixed in the factory 170 mm
- The ventilated room >400 mm
- Gravel , an inclination to the underdrains 1:20 50 mm

Instructions:

Humus and organic waste has to be removed. The seams between the insulation plates are sealed according to the structure plan. The height of ventilation space must be checked taking into consideration the HWV technique and a later maintenance possibility, case by case Area of the vents of the footing 1 o/oo of the floor area or separate chimney to the roof .

Properties: U-value 0.17 W/m²K

Use area: One-family houses and row of houses , block of flats

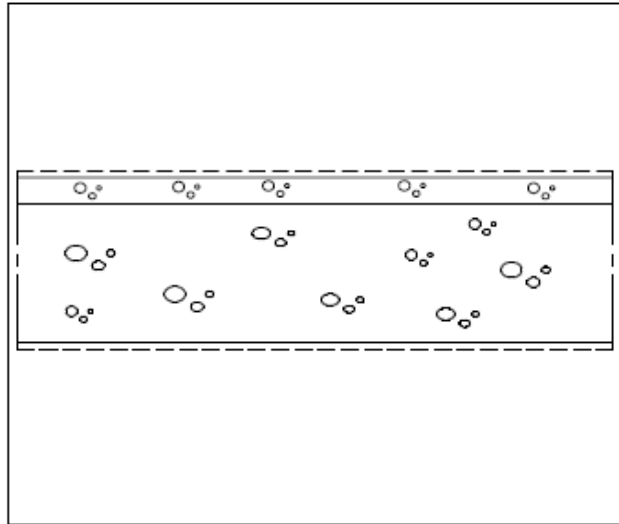
VP 201 Massive concrete slab**Structure layers:**

- Surface material and finish according to room explanation
- Surface concrete BY 31 class A-4-30 reinforcement : net 5-150 B500K 40 mm
- Bearing structure, in situ cast reinforced concrete slab according to structural designs
- Surface material and finish according to room explanation

Instructions: The structure moisture of the concrete must have dried sufficiently before the installation of the surface material.

Properties: Fire class : R60

Air borne insulation $R'_{w} = 55$ dB, when $h=240$

Impact noise insulation $L'_{n,w}=53$ dB

Use area: Blocks of flats

Office, business and public buildings

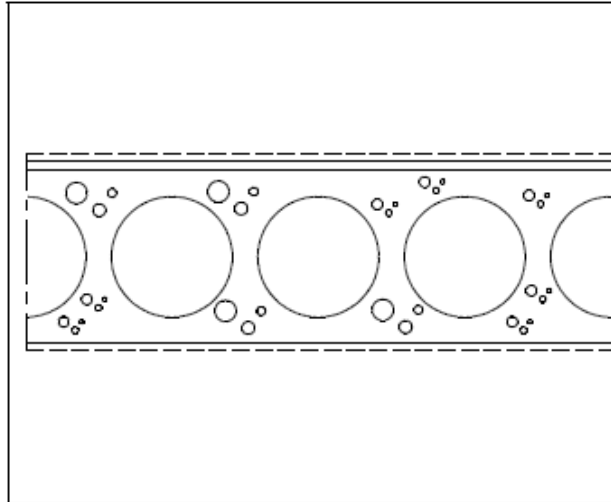
VP 501 Hollow Core Slab**Structure layers:**

- Surface material and finish according to room explanation
- Surface concrete BY 31 class A-4-30 reinforcement: mesh 5-150 B500K 5..20 mm
- Bearing structure, hollow core slab according to structural designs
- Surface material and finish according to room explanation

Instructions: The capacity of the surface must be checked at the point loads

Properties: Fire Class R60

Air borne insulation $R'_{w} = 55$ dB, when $g = 380$ kg/m²

Impact noise insulation $L'_{n,w} = 53$ dB

Use area: Blocks of flats

Office, business and public buildings

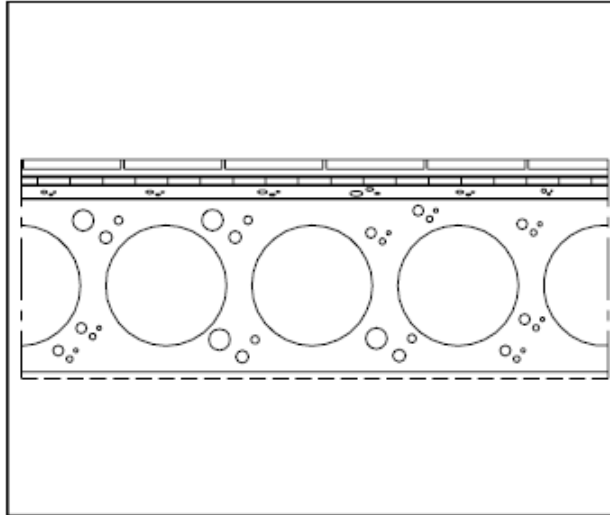
VP 503 Hollow Core Slab of the Damp Rooms**Structure layers:**

- Tiling according to room explanation
- Waterproof fastening plaster
- The fasterning layer
- Waterproof lifted up at least 150 mm with welded seams >1.5 mm
- Surface concrete BY 31 class A-4-30 inclination >1:100, near the wells >1:50 >20
mm Bearing structure, hollow core slab according to structural designs
- Surface material and finish according to room explanation

Instructions: The tiling is divided into parts at elastic seams according to the building specification.

Properties: Fire Class R60

Air borne insulation $R'_{w} = 55$ dB, when $g = 380$ kg/m²

Impact noise insulation $L'_{n,w} = 53$ dB

Use area: Blocks of flats

Office, business and public buildings

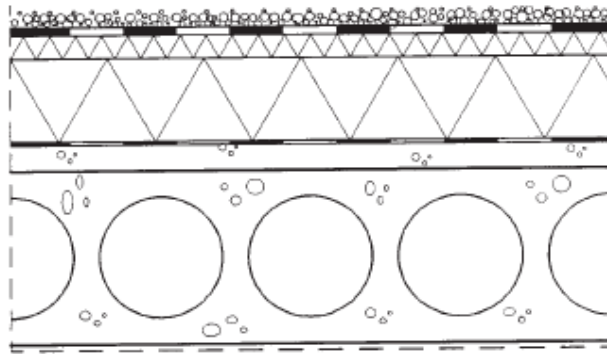
YP 507 Hollow Core Roof**Structure layers:**

- Protection paving
- Water proofing, class B
- Thermal insulation group O2.025, $\lambda_n = 0.037$ W/mK 35 mm
- Thermal insulation group O2.012, $\lambda_n = 0.037$ W/mK 400 mm
- Inclination concrete , inclinations > 1:80,
- Bearing concrete , hollow-core slab
- Surface and finish according to room explanation

Instructions: The inclination of the roofing is made by light concrete gravel. Roofing class K1 and without protection paving K2.

Properties: $U = 0.09$ W/m²K

Fire resistance class R60

Use area: Blocks of flats

Office, business and public buildings

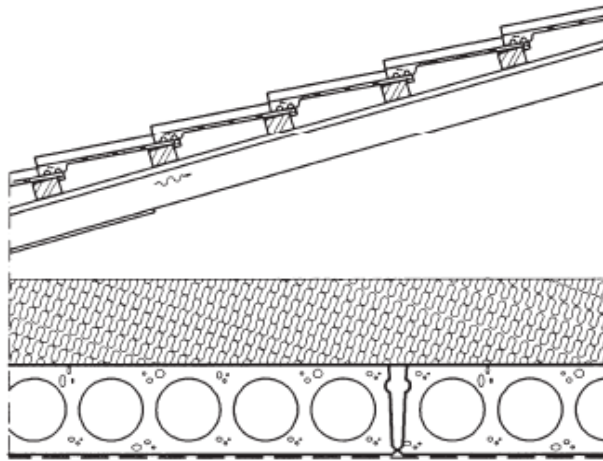
YP 507 Hollow Core Roof Slab

Structure layers:

Roof tile according to building specification

Wood strips 19x50mm

Secondary rafter

Under roofing

Rafter and a ventilated air space according to the structure designs

Thermal insulation group O2.012, $\lambda_n = 0.037 \text{ W/mK}$ 600 mm

Bearing concrete , hollow-core slab according to structure design

Surface and finish according to room explanation

Instructions: The inclination of the roof at least 1:4.

Properties: $U = 0.09 \text{ W/m}^2\text{K}$

Fire resistance class R60

Use area:

Small houses, block of flats

Blocks of flats

Office, business and public buildings

6 Concrete Construction

/22/

The most common form of concrete consists of Portland cement, construction aggregate (generally gravel and sand) and water. Concrete does not solidify from drying after mixing and placement; the water reacts with the cement in a chemical process known as hydration. This water is absorbed by cement, which hardens, gluing the other components together and eventually creating a stone-like material.

Concrete is used more than any other man-made material on the planet. It is used to make pavements, building structures, foundations, motorways/roads, overpasses, parking structures, brick/block walls and bases for gates, fences and poles.



FIG 132 Colosseum /22/

History

In the Roman Empire, concrete made from Quicklime, pozzolanic ash / pozzolana and an aggregate made from pumice was very similar to modern Portland cement concrete.

In 1756, the British engineer John Smeaton pioneered the use of Portland cement in concrete, using pebbles and powdered brick as aggregate. In the modern day, the use of recycled materials as concrete ingredients is gaining popularity because of increasingly stringent environmental legislation. The most conspicuous of these is fly ash, a by-product of coal power plants. This has a significant impact in reducing the amount of quarrying and landfill space required.

The properties of concrete have been altered since Roman and Egyptian times, when it was discovered that adding volcanic ash to the mix allowed it to set under water. Similarly, the Romans knew that adding horse hair made concrete less liable to shrink while it hardened, and adding blood made it more frost-resistant. In modern times, researchers have added other materials to create concrete that is extremely strong, and even concrete that can conduct electricity.

Portland cement is the most common type of cement in general usage, as it is a basic ingredient of concrete, mortar and plaster. An English engineer named Joseph Aspdin patented Portland cement in 1824, and it was named after the limestone cliffs on the Isle of Portland in England because of the similarity of its color to the stone quarried from Portland.

It consists of a mixture of oxides of calcium, silicon and aluminium. Portland cement and similar materials are made by heating limestone (a source of calcium) with clay and grinding

this product (called clinker), with a source of sulfate (most commonly gypsum). The resulting powder, when mixed with water, will become a hydrated solid over time. /22/

Water

Water suitable for human or animal consumption can be used for the manufacture of concrete. The w/c ratio (mass ratio of water to cement) is the key factor that determines the strength of concrete. A lower w/c ratio will yield a concrete which is stronger, a higher w/c ratio yields a concrete with a lower strength.

Cement paste is the material formed by combination of water and cementitious materials – that part of the concrete which is not aggregate or reinforcing. The workability or consistency is affected by the water content, the amount of cement paste in the overall mix and the physical characteristics (maximum size, shape and grading) of the aggregates. /22/

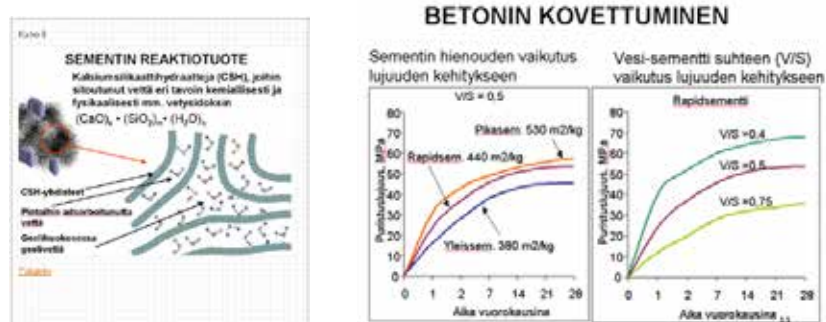

FIG 133 /www.betoni.com/

Aggregates

The water and cement paste hardens and develops strength over time. In order to ensure an economical and practical solution, both fine and coarse aggregates are utilised to make up the bulk of the concrete mixture. Sand, natural gravel and crushed stone are mainly used for this purpose. However, it is increasingly common for recycled aggregates (from construction, demolition and excavation waste) to be used as partial replacements of natural aggregates, whilst a number of manufactured aggregates, including air-cooled blast furnace slag and bottom ash are also permitted.

Admixtures

Admixtures are materials in the form of powder or fluids that are added to the concrete to give it certain characteristics not obtainable with plain concrete mixes. In normal use, admixture dosages are less than 5% by mass of cement, and are added to the concrete at the time of batching / mixing.

The most common types of admixtures are:

Accelerators speed up the hydration (hardening) of the concrete.

Retarders slow the hydration of concrete.

Air-entrainers add and distribute tiny air bubbles in the concrete, which will reduce damage during freeze-thaw cycles.

Plasticizers can be used to increase the workability of plastic or "fresh" concrete, allowing it be placed more easily, with less consolidating effort. Superplasticisers allow a properly designed concrete to flow in place even around congested reinforcing bars, see self consolidating concrete described below. Alternatively, they can be used to reduce the water content of a concrete (water reducers) while maintaining workability. This improves its strength and durability characteristics.

Pigments can be used to change the colour of concrete, for aesthetics. /22/

Additions

Additions are very fine inorganic materials that usually have pozzolanic or latent-hydraulic properties. They are added at the concrete mixer to improve the properties of concrete. The term is not used when the materials are added at the factory as constituents of blended cements.

Fly ash: A by-product of coal-fired elgenerating plants, it is used to partially replace Portland cement by up to 60% by mass. The properties of fly ash depend on the type of coal burnt. In general, silicious fly ash is pozzolanic, while calcareous fly ash has latent-hydraulic properties.

Ground granulated blast furnace slag (ggbfs): A by-product of steel production, it is used to partially replace Portland cement (by up to 80% by mass). It has latent-hydraulic properties.

Silica fume: A byproduct of the production of silicon and ferrosilicon alloys. Silica fume is similar to fly ash, but has a particle size in the order of 100 times smaller; this results in a higher surface to volume ratio, and thus a much faster pozzolanic reaction. Silica fume is used to increase strength and durability of concrete, but generally requires the use of superplasticizers for workability. /22/

Characteristics

During hydration and hardening, concrete needs to develop certain physical and chemical properties. Among others, mechanical strength, low permeability to moisture, and chemical and volumetric stability are all necessary. /22/

Workability

Workability (or consistency, as it is known in Europe) is the ability of a fresh (plastic) concrete mix to fill the form / mould properly with the desired work (vibration) and without reducing the concrete's quality. Workability depends on water content, chemical admixtures, aggregate (shape and size distribution), cementitious content and age (level of hydration). Raising the water content or adding chemical admixtures will increase concrete workability. Excessive water will lead to increased bleeding (surface water) and / or segregation of aggregates (when the cement and aggregates start to separate), with the resulting concrete having reduced quality. The use of an aggregate with an undesirable gradation can result in a very harsh mix design with a very low slump, which cannot be readily made more workable by addition of reasonable amounts of water.

Workability can be measured by the "slump test", a simplistic measure of the plasticity of a fresh batch of concrete following the ASTM C 143 or EN 12350-2 test standards. Slump is normally measured by filling an "Abrams cone" with a sample from a fresh batch of concrete. The cone is placed with the wide end down onto a level, non-absorptive surface. When the cone is carefully lifted off, the enclosed material will slump a certain amount due to the influence of gravity. A relatively dry sample will slump very little, and have a slump value of one or two

inches (25 or 50 mm), while a relatively wet concrete sample may slump as much as six or seven inches (150 to 175 mm).

Slump can be increased by adding chemical admixtures such as mid-range or high-range water reducing agents (super-plasticizers), without changing the water/cement ratio. It is bad practice to add extra water at the concrete mixer. High flow concrete, like self-consolidating concrete, is tested by other flow-measuring methods. One of these methods includes placing the cone on the narrow end and observing how the mix flows through the cone while it is being lifted gradually up. /22/

Curing

Because the cement requires time to fully hydrate before it acquires strength and hardness, concrete must be cured once it has been placed. Curing is the process of keeping concrete under a specific environmental condition until hydration is relatively complete. Good curing is typically considered to use a moist environment which promotes hydration, since increased hydration lowers permeability and increases strength, resulting in a higher quality material. Allowing the concrete surface to dry out excessively can result in tensile stresses, which the still-hydrating interior cannot withstand, causing the concrete to crack. Also, the amount of heat generated by the chemical process of hydration can be problematic for very large placements. Allowing the concrete to freeze in cold climates before the curing is complete will interrupt the hydration process, reducing the concrete strength and leading to scaling and other damage or failure. The effects of curing are primarily a function of specimen geometry, the permeability of the concrete, curing length, and curing history. /22/

Strength

Concrete has relatively high compressive strength, but significantly lower tensile strength (about 10% of the compressive strength). As a result, concrete always fails from tensile stresses — even when loaded in compression. The practical implication of this is that concrete elements subjected to tensile stresses must be reinforced. Concrete is most often constructed with the addition of steel or fiber reinforcement. The reinforcement can be by bars (rebar), mesh, or fibres, producing reinforced concrete. Concrete can also be prestressed (reducing tensile stress) using steel cables, allowing for beams or slabs with a longer span than is practical with reinforced concrete alone.

The ultimate strength of concrete is influenced by the water-cement ratio (w/c), the design constituents, and the mixing, placement and curing methods employed. All things being equal, concrete with a lower water-cement (cementitious) ratio makes a stronger concrete than a higher ratio. The total quantity of cementitious materials (portland cement, slag cement, pozzolans) can affect strength, water demand, shrinkage, abrasion resistance and density. As concrete is a liquid which hydrates to a solid, plastic shrinkage cracks occur soon after placement; but if the evaporation-rate is high, often can occur during finishing operations (for example in hot weather or a breezy day). Aggregate interlock and steel reinforcement in structural members often negates the effects of plastic shrinkage cracks, rendering them aesthetic in nature. Properly tooled control joints in slabs or early saw-cuts provide a plane of weakness so that cracks occur unseen inside the joint, making a nice aesthetic presentation.

Experimentation with various mix designs is generally done by specifying desired "workability" as defined by a given slump and a required 28 day compressive strength. The characteristics of the coarse and fine aggregates determine the water demand of the mix in order to achieve the desired workability. The 28 day compressive strength is obtained by determination of the correct amount of cementitious to achieve the required water-cement ratio. Only with very high strength concrete does the strength and shape of the coarse aggregate become critical in determining ultimate compressive strength.

The internal forces in certain shapes of structure, such as arches and vaults, are predominantly compressive forces, and therefore concrete is the preferred construction material for such structures. /22/

Elasticity

The modulus of elasticity of concrete is a function of the modulus of elasticity of the aggregates and the cement matrix and their relative proportions. The modulus of elasticity of concrete is relatively linear at low stress levels but becomes increasing non-linear as matrix cracking develops. The elastic modulus of the paste may be in the order of 10 GPa and aggregates about 45 to 85 GPa. The concrete composite is then in the range of 30 to 50 GPa./22/

Expansion and shrinkage

Concrete has a very low coefficient of thermal expansion. However if no provision is made for expansion very large forces can be created, causing cracks in parts of the structure not capable of withstanding the force or the repeated cycles of expansion and contraction.

As concrete matures it continues to shrink, due to the ongoing reaction taking place in the material. Brickwork made of clay tends to expand for some time after manufacture of the bricks, and the relative shrinkage and expansion of concrete and brickwork require careful accommodation when the two forms of construction interface. /22/

Cracking

Concrete is placed while in a wet (or plastic) state, and therefore can be manipulated and molded as needed. Hydration and hardening of concrete during the first three days is critical and abnormally fast drying and shrinkage due to factors such as evaporation from wind during placement may lead to increased tensile stresses at a time when it has not yet gained significant strength, resulting in shrinkage cracks. The early strength of the concrete can be increased by keeping it damp for a longer period during the curing process. Minimizing stress prior to curing minimizes cracking. High early-strength concrete is designed to hydrate faster, often by increased use of cement, which increases shrinkage and cracking. By nature, concrete shrinks, and therefore cracks. Plastic-shrinkage cracks are immediately apparent, visible within 0 to 2 days of placement, while drying-shrinkage cracks develop over time. Precautions such as mixture selection and joint spacing can be taken to encourage cracks to occur within an aesthetic joint, instead of randomly. /227

Creep

Creep is the term used to describe the permanent movement or deformation of a material in order to relieve stresses within the material. Concrete which is subjected to forces is prone to creep. Creep can sometimes reduce the amount of cracking that occurs in a concrete structure or element, but it also must be controlled. /22/

Self-compacting concretes

During the 1980s a number of countries including Japan, Sweden and France developed a range of concretes that were self-compacting. These self-compacting concretes (SCCs) are characterised by their extreme fluidity, behaving more like a thick fluid that is self-leveling, as opposed to the traditional concrete that needs consolidating, normally by vibration or packing. SCCs are characterized by extreme fluidity as measured by flow, typically between 700 – 750 mm, rather than slump no need for vibrators to compact the concrete. This emerging technology is made possible by the use of polycarboxylates instead of older "high-range water reducers". /22/

Concrete testing

Engineers usually specify the required compressive strength of concrete which is normally given as the 28 day compressive strength in megapascals (MPa). Twenty eight days is however a long time to wait to determine if desired strengths are going to be obtained, so three-day and seven-day strengths can be useful to predict the ultimate 28-day compressive strength of the concrete. A 25% strength gain between 7 and 28 days is often observed with 100% OPC (ordinary Portland cement) mixtures, and up to 40% strength gain can be realized with the inclusion of pozzolans and supplementary cementitious materials (SCM's) such as fly ash and/or slag cement. As strength gain depends on the type of mixture, its constituents, the use of standard curing, proper testing and care of cylinders in transport, etc. it becomes imperative to equally rely on testing the fundamental properties of concrete in its fresh, plastic state.

Concrete is typically sampled while being placed, with testing protocols requiring that test samples be cured under laboratory conditions (standard cured). Additional samples may be field cured (non-standard) for the purpose of early stripping strengths, ie. form removal, evaluation of curing, etc. but the standard cured cylinders comprise acceptance criteria. Concrete tests can measure the "plastic" (unhydrated) properties of concrete prior to, and during placement. As these properties affect the hardened compressive strength and durability of concrete (resistance to freeze-thaw), the properties of slump (workability), temperature, density and age are monitored to ensure the production and placement of 'quality' concrete.

Tests are performed per ASTM International or CSA (Canadian Standards Association) and European methods and practices. Technicians performing concrete tests must be certified. Structural design and material properties are often specified in accordance with ACI International code (www.concrete.org) under the "prescription" or "performance" purchasing options per ASTM C94 (www.astm.org).

Compressive strength tests are conducted using an instrumented hydraulic ram to compress a cylindrical sample to failure. Tensile strength tests are conducted either by three-point bending of a prismatic beam specimen or by compression along the sides of a cylindrical specimen. /22/

Concrete recycling

When structures made of concrete are to be demolished, concrete recycling is a common method of disposing of the rubble. Concrete debris was once routinely shipped to landfills for disposal, but recycling has a number of benefits that have made it a more attractive option in this age of greater environmental awareness, more environmental laws, and the desire to keep construction costs down. /22/

Reinforced concrete

Reinforced concrete is concrete in which reinforcement bars ("rebars") or fibers have been incorporated to strengthen the material that would otherwise be brittle.

The use of reinforced concrete is a relatively recent invention, usually attributed to Jean-Louis Lambot in 1848. Joseph Monier, a French gardener, patented a design for reinforced garden tubs in 1868, and later patented reinforced concrete beams and posts for railway and road guardrails.

The major developments of reinforced concrete have taken place since the year 1900; and from the late 20th century, engineers have developed sufficient confidence in a new method of reinforcing concrete, called prestressed concrete, to make routine use of it. /22/



FIG 34 Rebar for foundations /22/

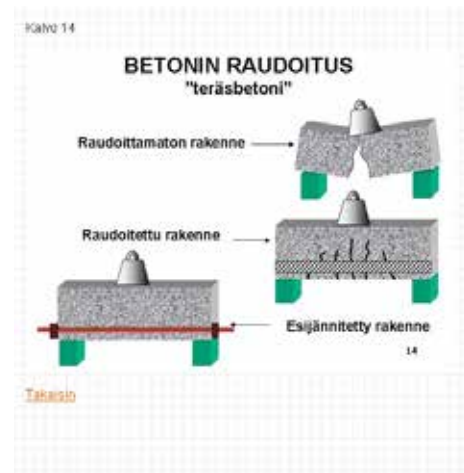

FIG 135 Reinforced Concrete /www.betoni.com/

Physics and statics

Concrete is a mixture of Portland cement and stone aggregate. When mixed with a small amount of water, Portland cement hydrates to form a microscopic opaque crystal lattice structure encapsulating and locking the aggregate into its rigid structure. Typical concrete mixes have extremely high resistance to downward compressive stresses (about 35 N/mm^2); however, any appreciable stretching or bending (tension) will break the microscopic rigid lattice resulting in cracking and separation of the concrete. For this reason, typical concrete must be supported or placed on an earth footing to prevent cracking.

If an elastic material, such as steel, is placed in concrete, then this composite material, reinforced concrete, can resist stretching, bending, and other direct tensile actions.

A reinforced concrete section where the concrete takes the compression and steel takes the tension is so efficient in carrying forces that it can be made into almost any shape and size for the construction industry. Depending on the type of concrete mix and steel employed, reinforced concrete structures can support 300 to 500 times their combined weight and behave, according to general mechanics, as a single structural entity.

Three physical characteristics give reinforced concrete its special properties. Firstly, the coefficient of thermal expansion of concrete is similar to that of steel, eliminating internal stresses due to differences in thermal expansion or contraction. Secondly, when the cement paste within the concrete hardens this conforms to the surface details of the steel, permitting any stress to be transmitted efficiently among the different materials. Usually steel bars are roughened or corrugated to further improve the bond or cohesion between the concrete and steel. Thirdly, the alkaline chemical environment provided by calcium carbonate (lime) causes a passivating film to form on the surface of steel, making it much more resistant to corrosion than it would be in neutral or acidic conditions.

Although the ridges on rebar offer increased surface area to resist tension forces, sometimes there is not enough embedment of reinforcing steel in the concrete to fully transfer tensile forces between the concrete and rebar. In these cases the rebar may be bent into a 180 degree hook, which itself will transfer half of the capacity of the rebar to resist tension forces to the concrete.

In some structural members where a small cross-section is desired, steel may be used to carry some of the compressive load as well as tensile load. This occurs in columns. Continuous beams in buildings generally require some compressive steel at the columns, but beams and slabs usually have reinforcing steel only on the tension (bottom) side. In the case of continuous girders where the tensile stress alternates between top and bottom of the member, multiple runs (layers) of steel may be used or the steel may be bent into a zig-zag shape within the beam.

The relative amount of steel required for typical strengthening is usually quite small and varies from 1% for most beams and slabs to 6% for some columns (based on the area of a cross section of the member). Reinforcing bars are round and vary by from 8 to 32 mm. In conservative construction projects like roadways and bridges, a series of rebar curtains or matrices are embedded in the concrete. Typically, concrete will reach its nominal design strength after 28 days.

Corrosion and freezing/thawing may damage poorly designed or constructed reinforced concrete. When rebar corrodes, the rust expands, cracking the concrete and unbonding the rebar from the concrete. Freeze/thaw damage occurs when water penetrates the surface and freezes. The expansion of freezing water, and subsequent thawing, in microscopic cracks widens the cracks, causing flaking, and eventual structural failure.

In wet and cold climates, reinforced concrete for roads, bridges, parking structures and other structures that may be exposed to deicing salt may require epoxy-coated rebar or a well composed concrete well planes structure. Epoxy coated rebar can easily be identified by the light green color of its epoxy coating. /22/

Common failure modes of steel reinforced concrete

Corrosion and freeze/thaw cycles may damage poorly designed or constructed reinforced concrete. When rebar corrodes, the oxidation products (rust) takes more space than the original steel and tends to flake, cracking the concrete and unbonding the rebar from the concrete.

Carbonation

The water in the pores of the cement is normally alkaline, this alkaline environment is one in which the steel is passive and does not corrode. According to the pourbaix diagram for iron the metal is passive when pH is above 9.5.

The carbon dioxide from the air reacts with the alkali in the cement and makes the pore water more acidic, thus lowering the pH. Carbon dioxide will start to carbonate the cement in the concrete from the moment the object is made, this process will start at the surface and slowly move deeper and deeper into the concrete. If the object is cracked the carbon dioxide of the air will be more able to penetrate deep into the concrete. When designing a concrete structure it is normal to state the concrete cover for the rebar (the depth within the object that the rebar will be). The minimum concrete cover is normally regulated by design or building codes. If the reinforcement is too close to the surface, then an early failure due to corrosion may occur.

One method of testing a structure for carbonation is to drill a fresh hole in the surface and then treat the surface with phenolphthalein, this will turn pink when in contact with alkaline cement. It is then possible to see the depth of carbonation. An existing hole is no good as the surface will already be carbonated.

Chlorides

Chlorides, including sodium chloride, promote the corrosion of steel rebar. For this reason, in mixing concrete only fresh water may be used, and the use of salt for deicing concrete pavements is strongly discouraged.

Sulfate attack

Sulfates in soil or groundwater can react with Portland cement causing expansive products, e.g. ettringite or thaumasite, which can lead to early failure. /22/

Prestressed concrete

Traditional reinforced concrete is based on the use of steel reinforcement bars, rebar, inside poured concrete.

Prestressed concrete, invented by Frenchman Eugène Freyssinet in 1928, is a method for overcoming concrete's natural weakness in tension. It can be used to produce beams, floors or bridges with a longer span than is practical with ordinary reinforced concrete. Prestressing tendons (generally of high tensile steel cable or rods) are used to provide a clamping load which produces a compressive stress that offsets the tensile stress that the concrete member would otherwise experience due to a bending load.

Prestressing can be accomplished in three ways:

Pre-tensioned concrete is cast around already tensioned tendons. This method produces a good bond between the tendon and concrete, which both protects the tendon from corrosion and allows for direct transfer of tension. The cured concrete adheres and bonds to the bars and when the tension is released it is transferred to the concrete as compression by static friction. However, it requires stout anchoring points between which the tendon is to be stretched and the tendons are usually in a straight line. Thus, most pretensioned concrete elements are prefabricated in a factory and must be transported to the construction site, which limits their size. Pre-tensioned elements may be balcony elements, lintels, floor slabs, beams or foundation piles. An innovative bridge construction method using pre-stressing is described in stressed ribbon bridge.

Bonded post-tensioned concrete is the descriptive term for a method of applying compression after pouring concrete and the curing process (in situ). The concrete is cast around a plastic, steel or aluminium curved duct, to follow the area where otherwise tension would occur in the concrete element. A set of tendons is fished through the duct and the concrete is poured. Once the concrete has hardened, the tendons are tensioned by hydraulic jacks that react against the concrete member itself. When the tendons have stretched sufficiently, according to the design specifications (see Hooke's law), they are wedged in position and maintain tension after the jacks are removed, transferring pressure to the concrete. The duct is then grouted to protect the tendons from corrosion. This method is commonly used to create monolithic slabs for house construction in locations where expansive soils (such as adobe clay) create problems for the typical perimeter foundation. All stresses from seasonal expansion and contraction of the underlying soil are taken into the entire tensioned slab, which supports the building without significant flexure.

Post-stressing is also used in the construction of various bridges, both after concrete is cured after support by falsework and by the assembly of prefabricated sections, as in the segmental bridge.

Prestressed concrete is the predominating material for floors in high-rise buildings, foundations for residential buildings in soft soil areas, bridges and in the construction of water towers and water tanks. Post-tensioning is also used to reinforce the large concrete chambers in nuclear reactors.

The advantages of prestressed concrete include lower construction costs; thinner slabs – especially important in high rise buildings in which floor thickness savings can translate into

additional floors for the same (or lower) cost and fewer joints, since the distance that can be spanned by post-tensioned slabs exceeds that of reinforced constructions with the same thickness. Increasing span lengths increases the usable unencumbered floorspace in buildings; diminishing the number of joints leads to lower maintenance costs over the design life of a building, since joints are the major locus of weakness in concrete buildings. /22/

Rebars



FIG 136 Two coils of common rebar.

Rebar is common steel reinforcing bar, an important component of reinforced concrete and reinforced masonry structures. It is usually formed from mild steel, and is given ridges for better frictional adhesion to the concrete.

Concrete is a material that is very strong in compression, but virtually without strength in tension. To compensate for this imbalance in concrete's behavior, rebar is formed into it to carry the tensile loads.

Masonry structures and the mortar holding them together have similar properties to concrete and also have a limited ability to carry tensile loads. Some standard masonry units like blocks and bricks are made with strategically placed voids to accommodate rebar, which is then secured in place with grout. This combination is known as reinforced masonry.

While any material with sufficient tensile strength could conceivably be used to reinforce concrete, steel and concrete have similar coefficients of thermal expansion: a concrete structural member reinforced with steel will experience minimal stress as a result of differential expansions of the two interconnected materials caused by temperature changes.

Although rebar has ridges that bind it mechanically to the concrete with friction, it can still be pulled out of the concrete under high stresses, an occurrence that often precedes a larger-scale collapse of the structure. To prevent such a failure, rebar is either deeply embedded into adjacent structural members, or bent and hooked at the ends to lock it around the concrete and other rebars. This first approach increases the friction locking the bar into place while the second makes use of the high compressive strength of concrete.

Common rebar is made of unfinished steel, making it susceptible to rusting. As rust takes up greater volume than the iron or steel from which it was formed, it causes severe internal pressure on the surrounding concrete, leading to cracking, spalling, and ultimately, structural fail-

ure. This is a particular problem where the concrete is exposed to salt water, as in bridges built in areas where salt is applied to roadways in winter, or in marine applications. Epoxy-coated rebar or stainless steel rebar may be employed in these situations at greater initial expense, but significantly lower expense over the service life of the project. Most grades of steel used in rebar cannot accept welding, which could be useful to bind several pieces of rebar together. Special grades of rebar steel and welding rods make welding by expert welders possible.

To prevent workers from accidentally impaling themselves, the protruding ends of steel rebar are often bent over or covered with special plastic "mushroom" caps. /22/

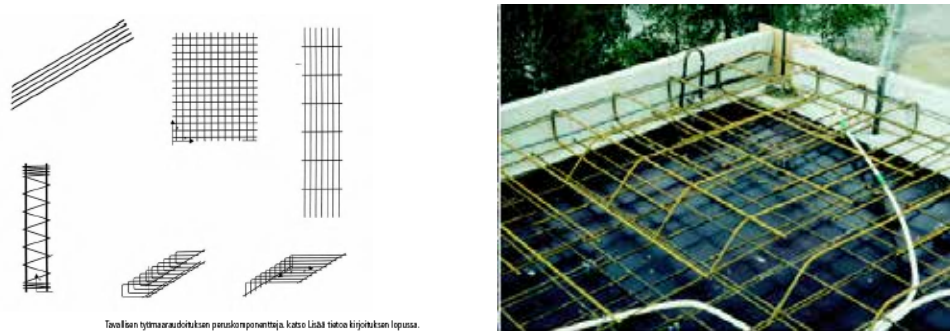

FIG 137 Rebars and meshes /22/

Concrete casting



FIG 138 Concrete casting /22/



FIG 139

7 Multi-Storey Residential Houses

/1/

The following are extracts from Virtual Polytechnic's Residential Blocks of Flats material the year 2005:

The Multi-Storey Residential House Project is divided in to the following sections:

- Project Management
- BIM Building Information Modelling
- Building Design
- Structural design
- HVAC design
- Works contracts
- Production Planning
- Site Technology



FIG 140 Permit Drawings

7.1 Building Designs

Building designs include e.g. the permit drawings, implementation drawings and documents and specification. The permit drawings include the site plan, floor plans, sections, elevations and structural details. The implementation drawings include detailed floor plans, window and door lists, furniture designs and details. When the building is modelled with a CAD software the building designs can be produced from the model. The Building Information Model can be use in all the phases on the construction: design, quantities, pricing, scheduling and monitoring.

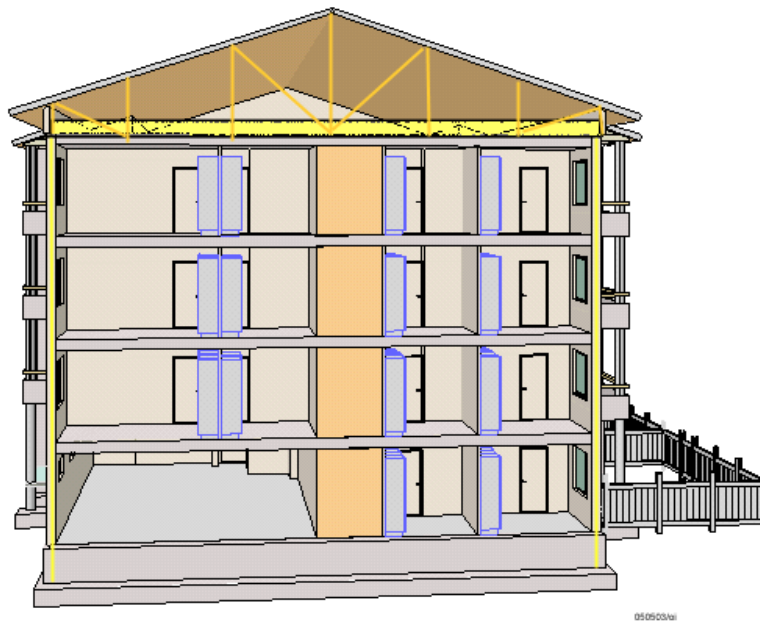

FIG 141

7.2 Structural Design

In the structural design include framing, loads and structural calculations, foundations, building components, building connections, roof structures and Master Document. Blocks of flats can be constructed either as concrete, timber, masonry or steel frame buildings.

Structural design section is divided usually into the following topics:

- Structure Plans
- Foundations
- Frame and stiffening
- Building Components
- Thermal Insulation
- Fire Design
- Drawings

7.3 Virtual Concrete Unit Multi-Storey BES- House

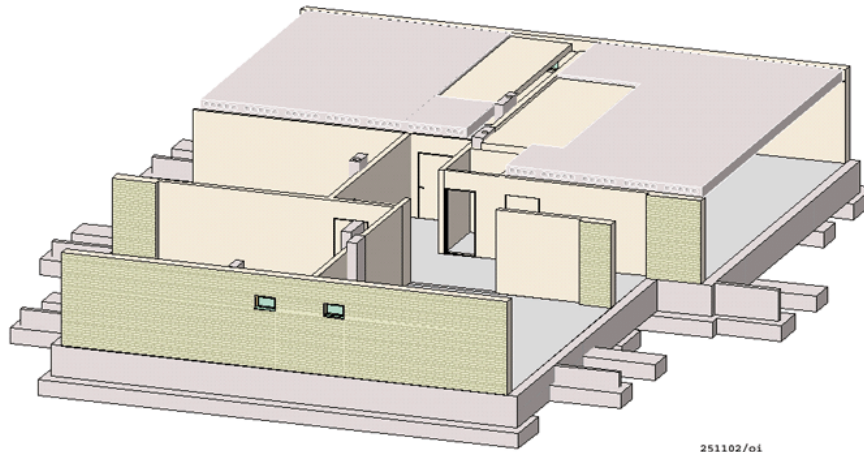

FIG 142 Picture the frame of a concrete unit block of flats

BES block of flats

In the following the part B has been designed as in situ. The student's task is to make the design with the concrete unit technique. The plans contain, among others, the following documents:

- 23.40 Basic information
- 23.41 Structural calculations
- 23.42 Building Components
- 23.43 Framing
- 23.431 Plans
- 23.4310 Hollow core slab layout
- 23.4311 Ring and seam rebars
- 23.4312 Connection details
- 23.432 Section drawings
- 23.44 Elevation drawings
- 23.441 Concrete unit designs
- 23.45 Foundation plans
- 23.46 Frame parts
- 23.461 Stairs
- 23.462 Lift

- 23.463 Bomb shelter
 23.47 Roof
 23.48 Specifications

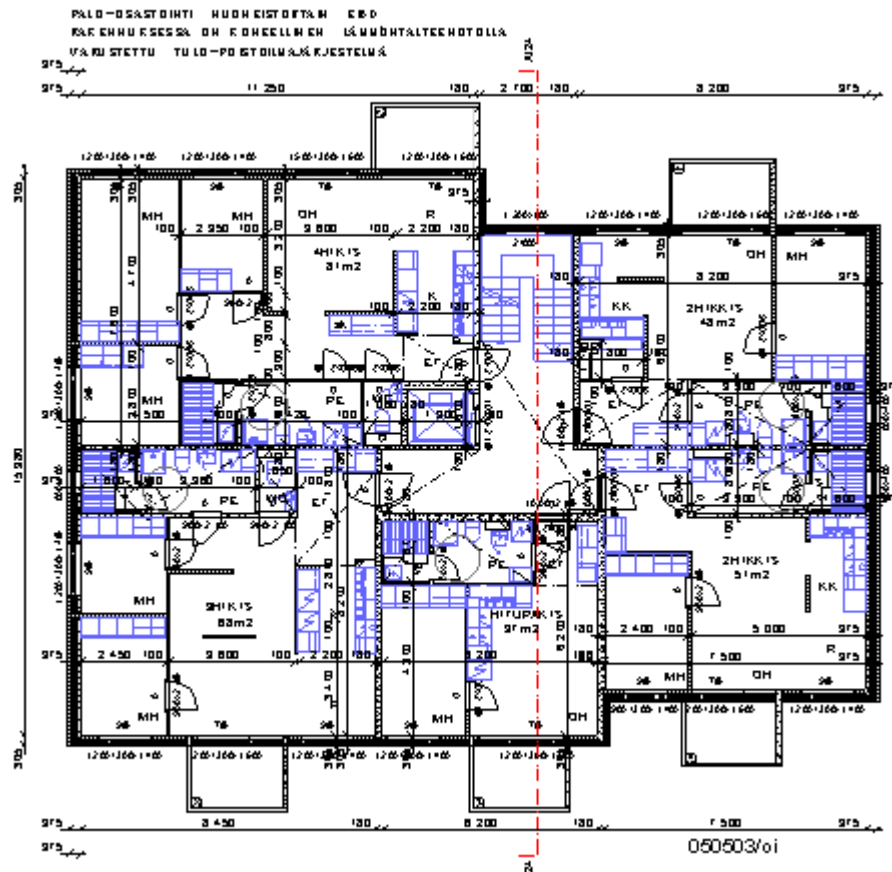

FIG 143 Lamel B plan

Concrete Unit Frame

The designers and contractors choose the frame solution of the building together. The chosen solution affects the spans of the frame and to the building components. The Concrete Unit Frame follows usually the bearing wall system. In the system the walls between the flats and the end exterior walls are bearing and the floor slab is parallel with the body. The walls which are between the flats and against stairs room are 200 mm thick plain concrete walls and they must fulfill the airborne sound insulation demand, $R'w=55$ dB. The floor unit is usually a 1200 mm wide, prestressed and perforated hollow-core slab. The height of the slabs are usually 370 mm. To fulfill the impact noise insulation requirement $L'n.w=53$ dB the hollow core slab must be massive enough or an extra surface concrete slab must be casted over it.

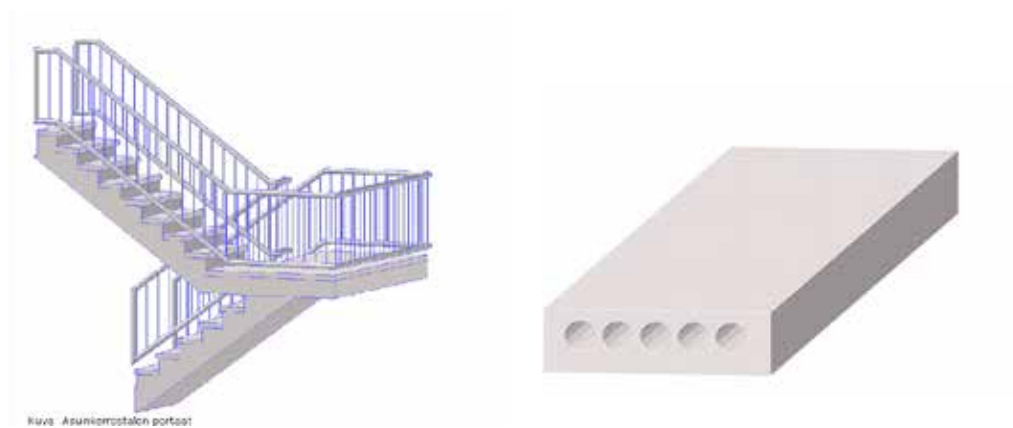

FIG 146 Frame components

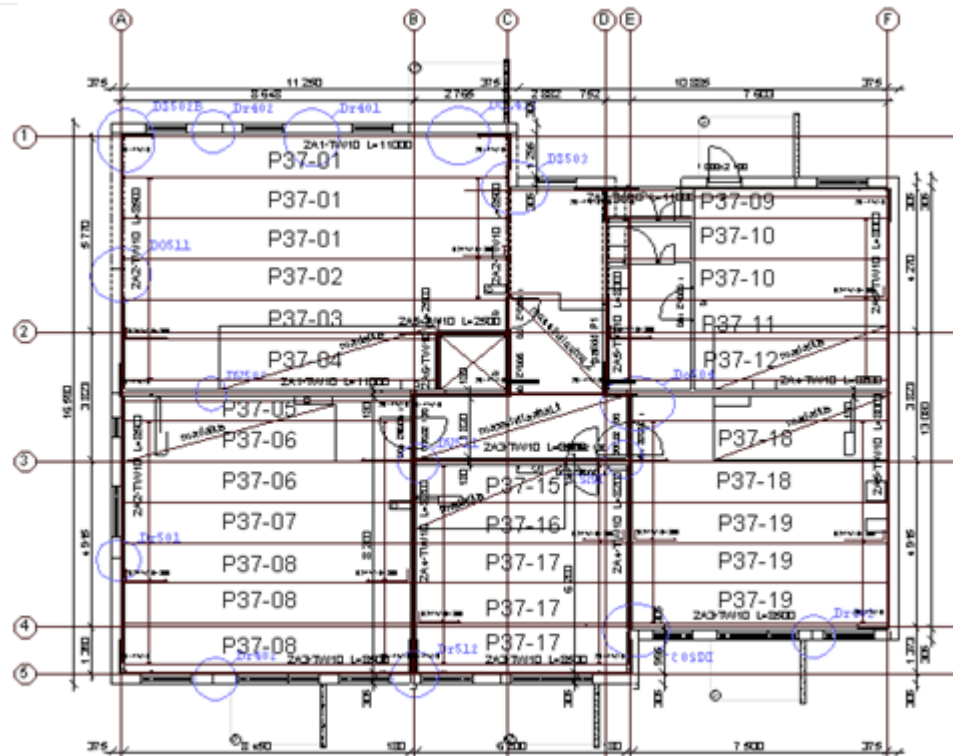

FIG 147 The hollow core slab layout

The hollow core slab layout

In the hollow core layout e.g. the slabs with their marks, the vertical and horizontal structures, stiffening structures, loads, holes, the section and detail are presented.

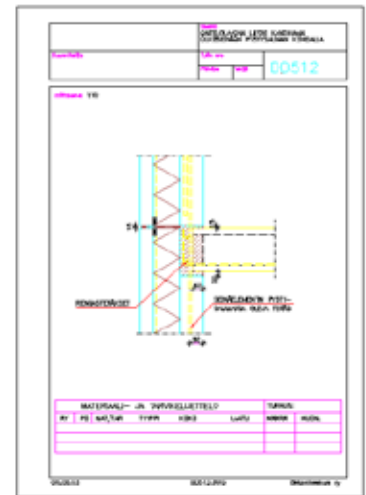
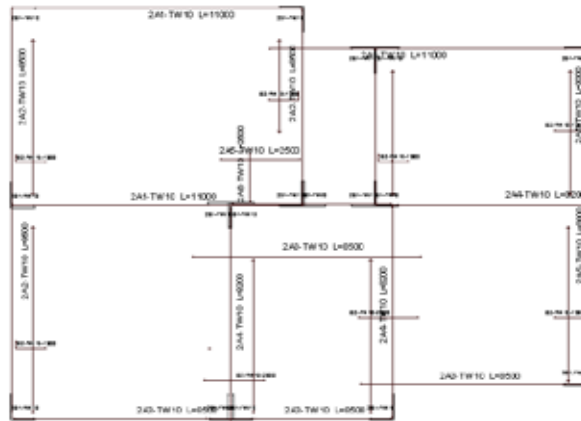

FIG 148 Ring rebars and a connection detail

Ring rebars and seam rebars of the hollow core slab are designed.

Design the ring rebar of the lamella A.

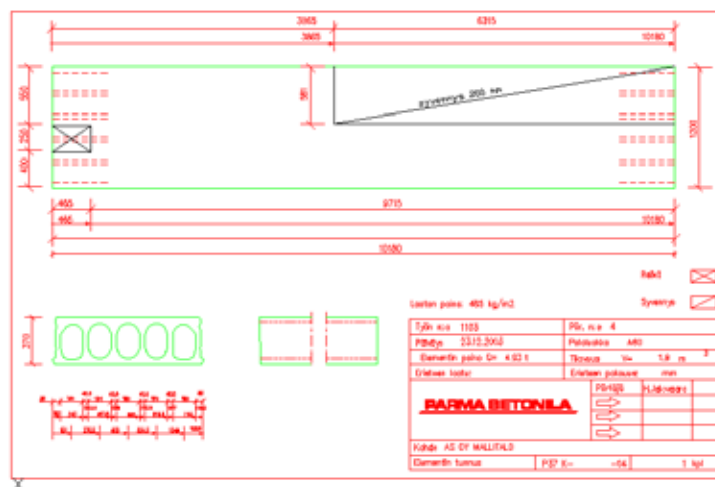

FIG 149 The design of the a hollow core slab unit

A production picture is made of every type of the hollow core slabs.

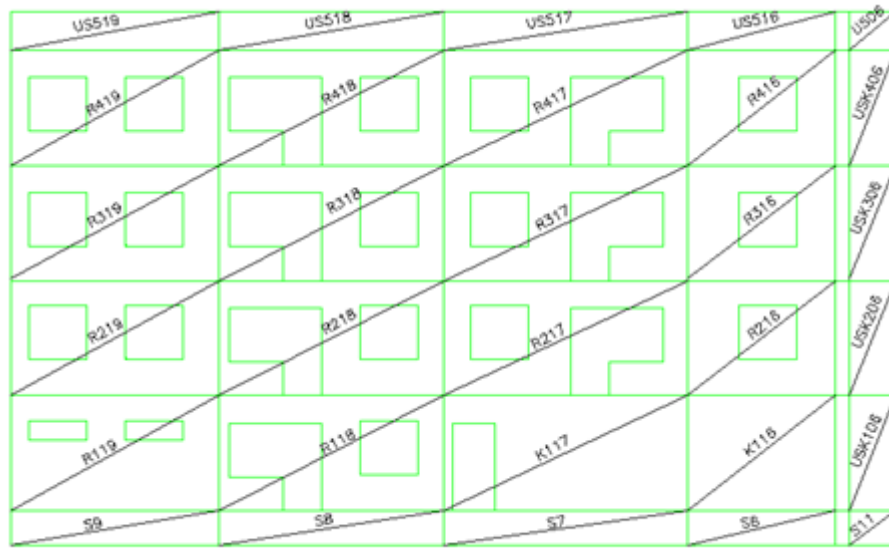

FIG 150 The elevation layout

Example of the elevation layout of the prefabricated multi-storey building where the different type sandwich elements are named: a footing unit, a nonbearing sandwich unit, a bearing external sandwich, a balcony element, e.g.

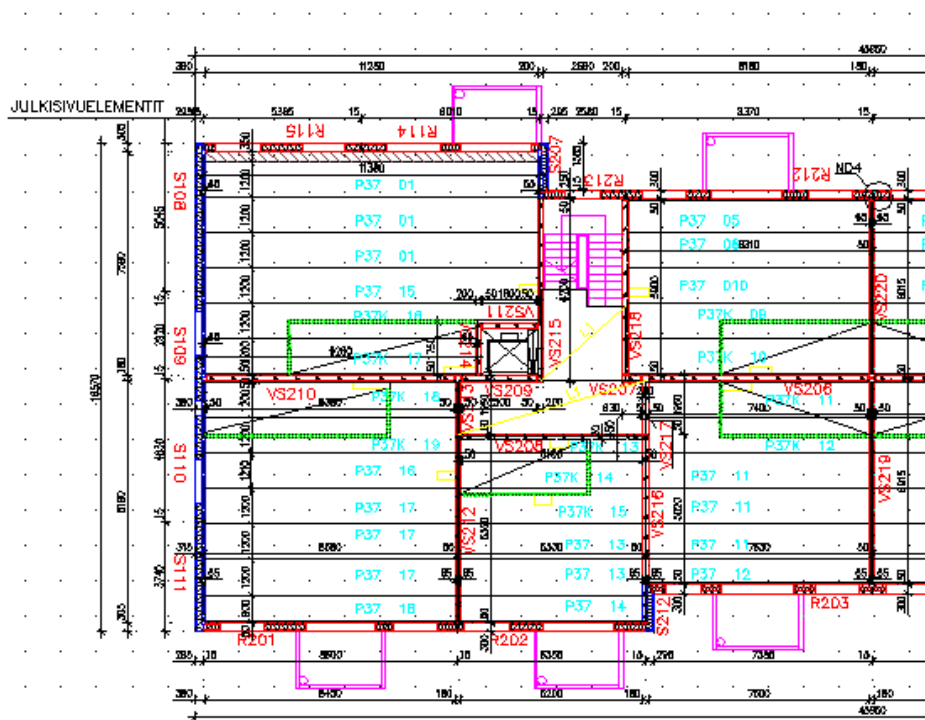

FIG 151 The wall units specified in the plans

The wall elements are marked in the floor plans in which the bearing wall elements between the flats, non bearing partition walls, exterior wall units, stairs elements et cetera are presented

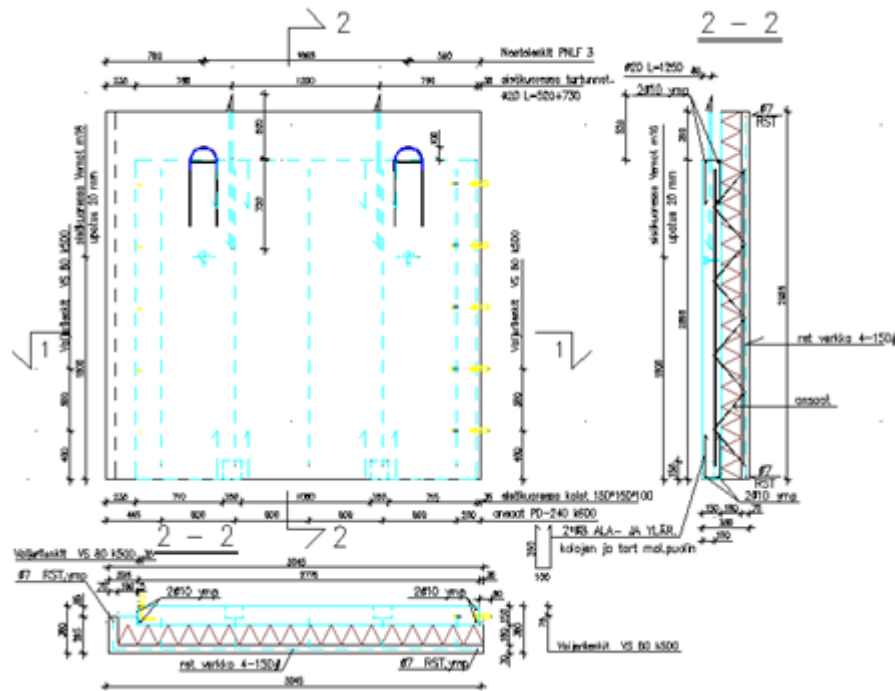

FIG 152 The concrete sandwich design

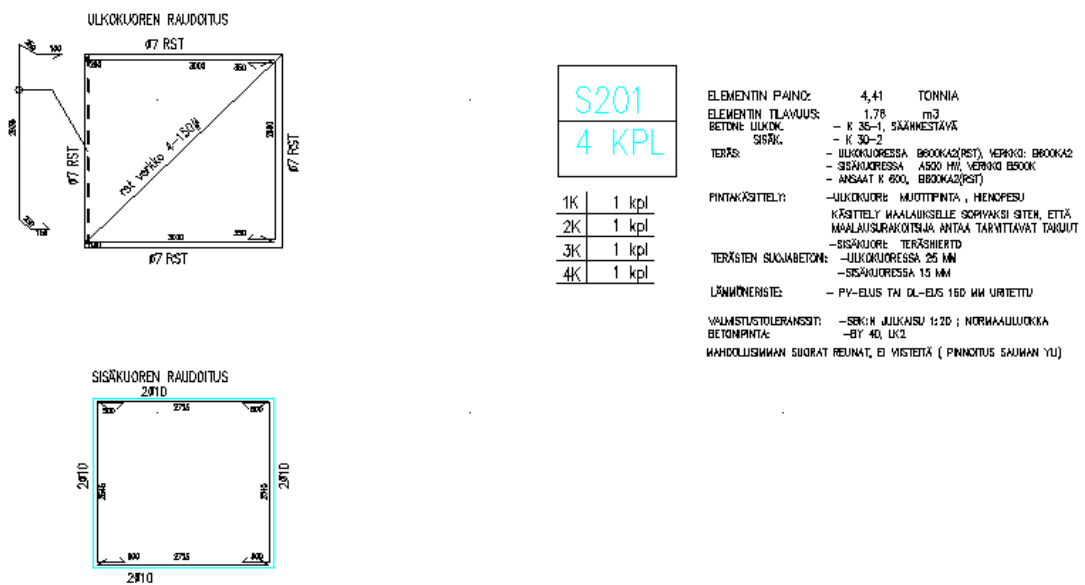

FIG 153 Bearing partition wall

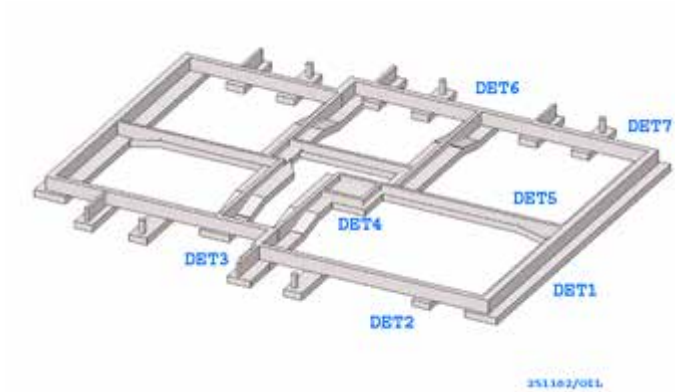

FIG 154 Foundations of a Prefabricated Multi-Storey house

Foundations of the BES residential building

The basement is designed according to the residential floor plan. The loads of the building are taken to bearing structures and to the foundations and finally to the soil. According to the quality of the soil the solution is either for example a strip foundation directly on the soil, a foundation on rock or a pile foundation.

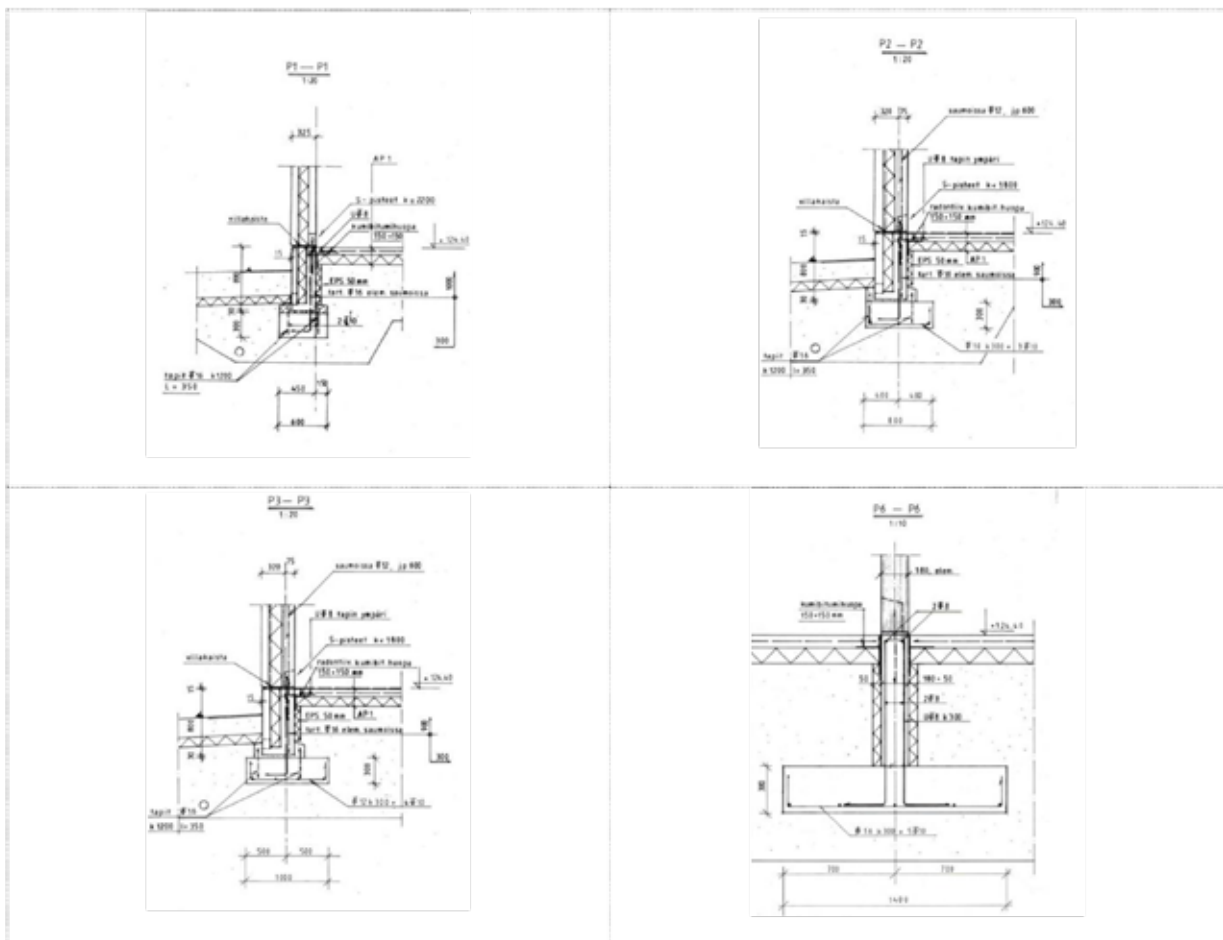

FIG 155 Foundation Details

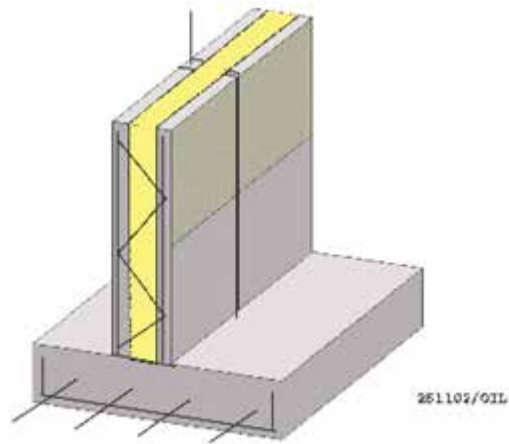

FIG 156 Detail 1

A section of a footing and a strip foundation.

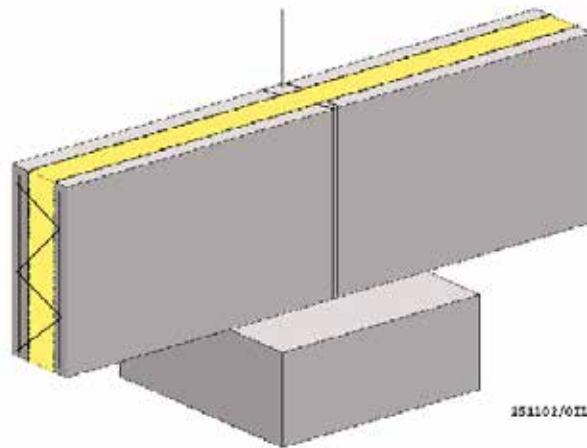

FIG 157 Detail 2

The pad foundation of the vertical joint of the nonbearing footing element.

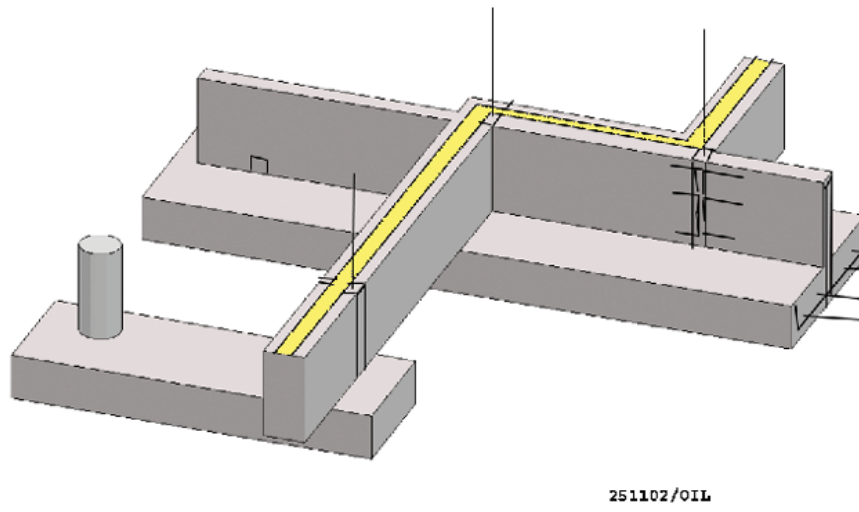

FIG 158 Detail 3

A foundation section of the column and post wall of the balcony.

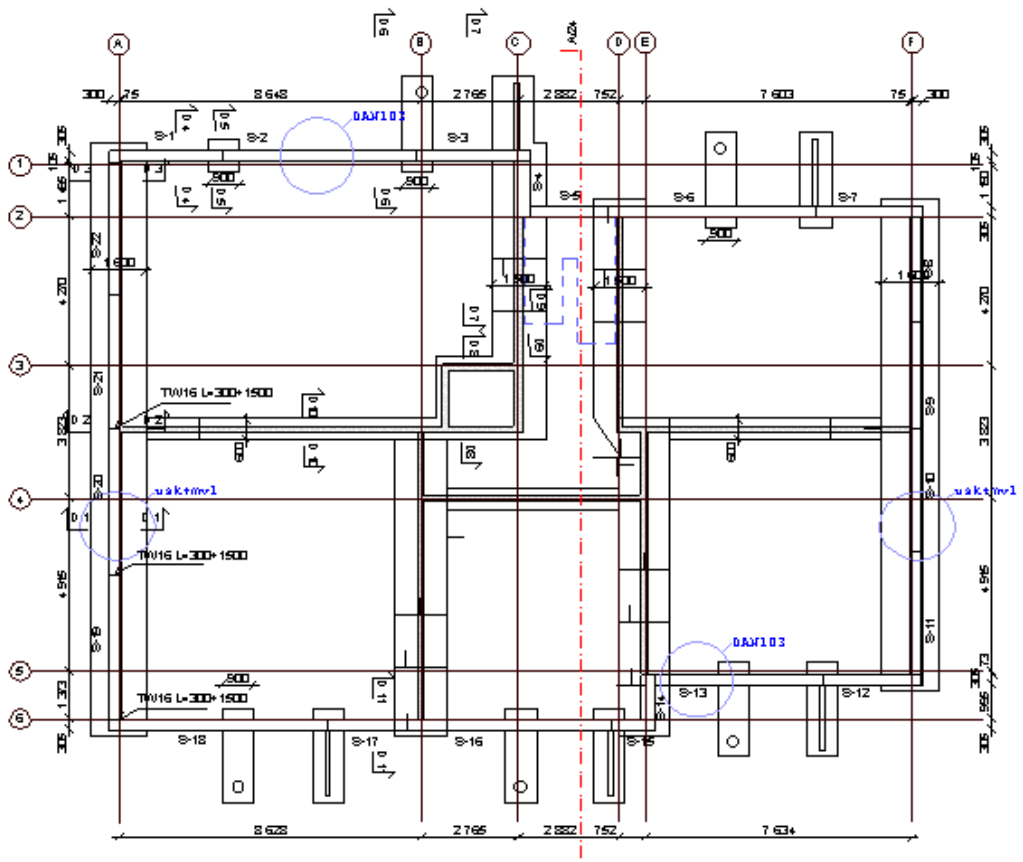

FIG 159 Detail

The foundation plan shows the location, form of strips and pads, sizes, sections, frost insulation, radon protection, plumbing etc. Complete the design

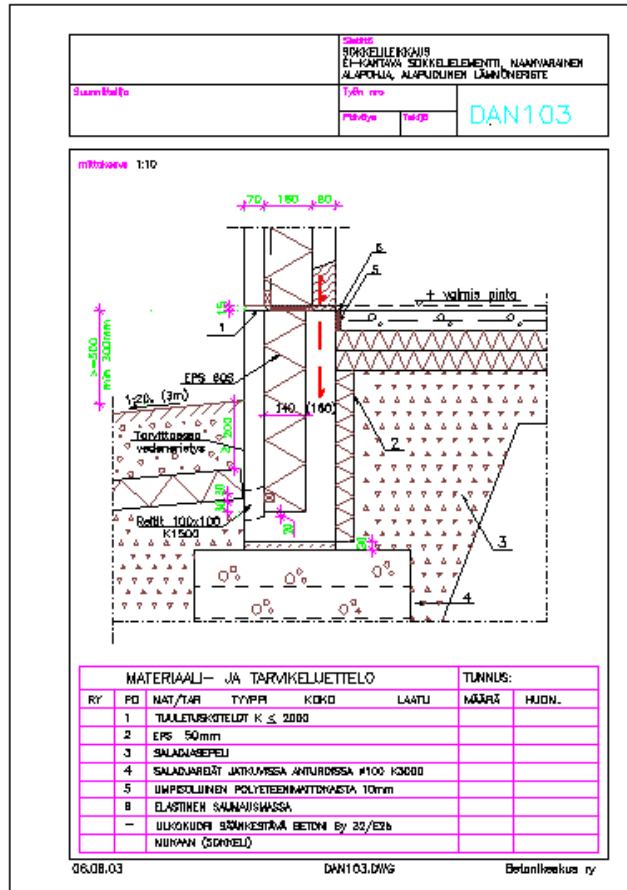

FIG 160 Foundation detail section DAN 103

The foundations details are designed.

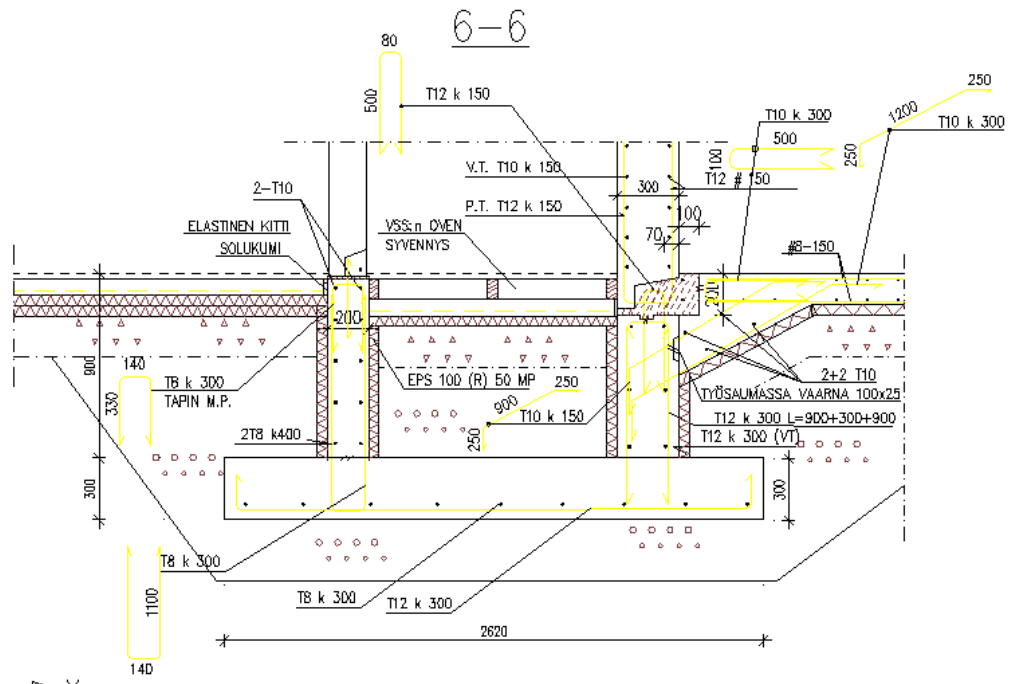

FIG 161 Foundation detail 6-6

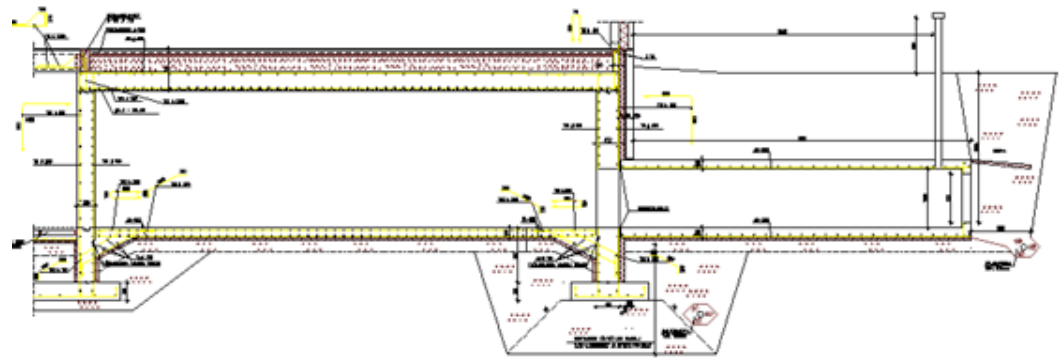

FIG 162 Bomb shelter section

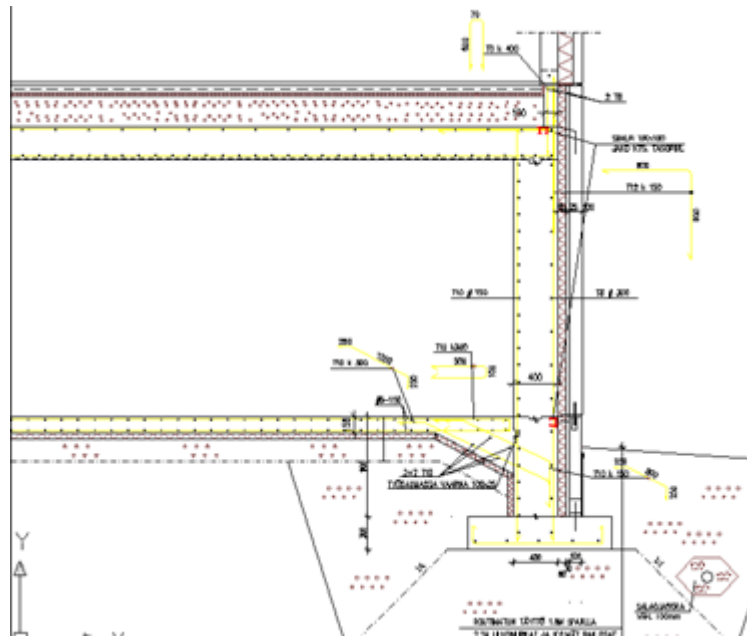

FIG 163 Bomb shelter detail

The exterior walls of the bomb shelter of the S1 class are usually 450 mm thick and the slab 300 mm thick. The thicknesses are determined by radiation or cracking. The inner surfaces of the walls and slabs are installed with meshes spacing # 150 and outer surfaces with meshes # 300 as a minimum reinforcement.

7.4 Virtual In Situ Multi – Storey Building

/1/

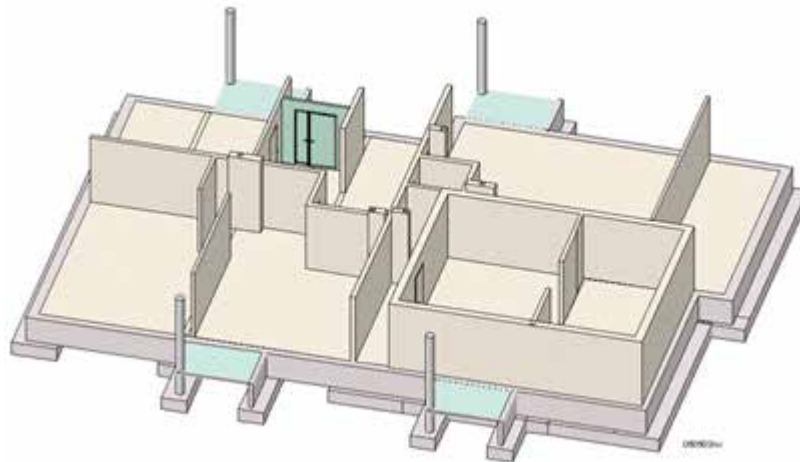

FIG 164 In Situ Frame

The structural design include framing, loads and structural calculations, foundations, building components, building connections, roof structures and Master Document. The multi-storey residential house is now constructed in situ.

The designs contain e.g. following :

- 22.40 Project information
- 22.41 Structural calculations
- 22.42 Building Components

- 22.43 Body
 - 22.430 Level drawings
 - 22.431 Cutting drawings
 - 22.432 Body details
 - 22.433 Iron mounting plans
 - 22.434 Lists, captions

- 22.44 Facade plans
- 22.45 Establishment plans
- 22.46 Runkorakennusosa
 - 22.461 Portaat
 - 22.462 Lift
 - 22.463 Bomb shelter
- 22.47 A roof and supplementing structures
- 22.48 Specificationss

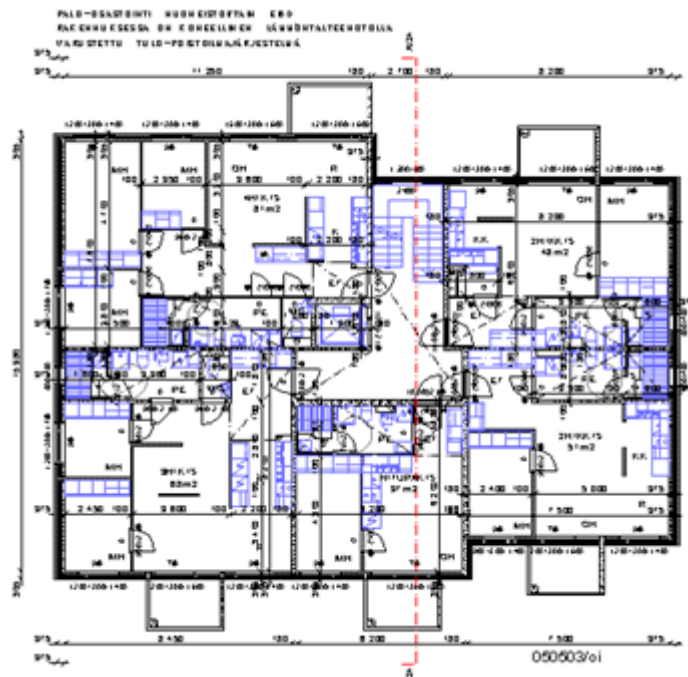

FIG 165 Residential Plan

The In Situ Frame

/5/

The designers and contractors choose the frame solution of the building together. The chosen solution affects the spans of the frame and to the building components. The in situ construction includes the moulding, reinforcement and concrete cast. The walls which are between the flats and against stairs room are usually 200 mm thick plain concrete walls and they must fullfill the airborne sound insulation demand, $R'w=55$ dB. The floor unit is usually a 240 mm massive slab to fullfill the impact noise insulation requirement $L'n.w=53$ dB.

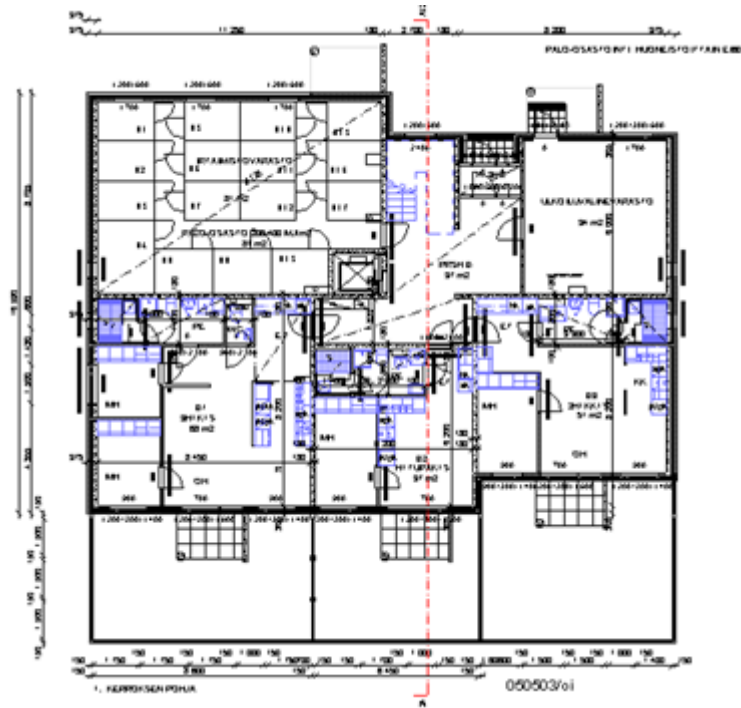

FIG 166 Basement plan

The spans of the in situ frame must be limited max 5–7 m.

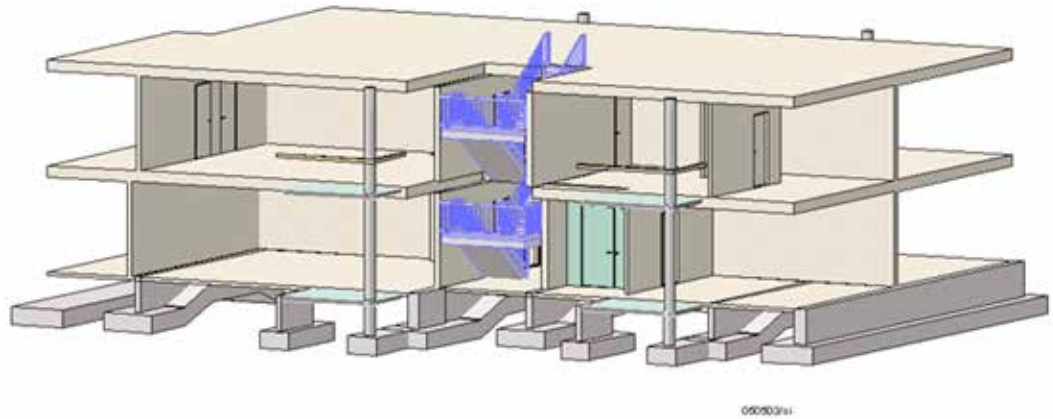

FIG 167 In situ frame

The in situ frame is usually constructed according to the bearing partition wall system.

ALAPINNAN RAUDOITEET

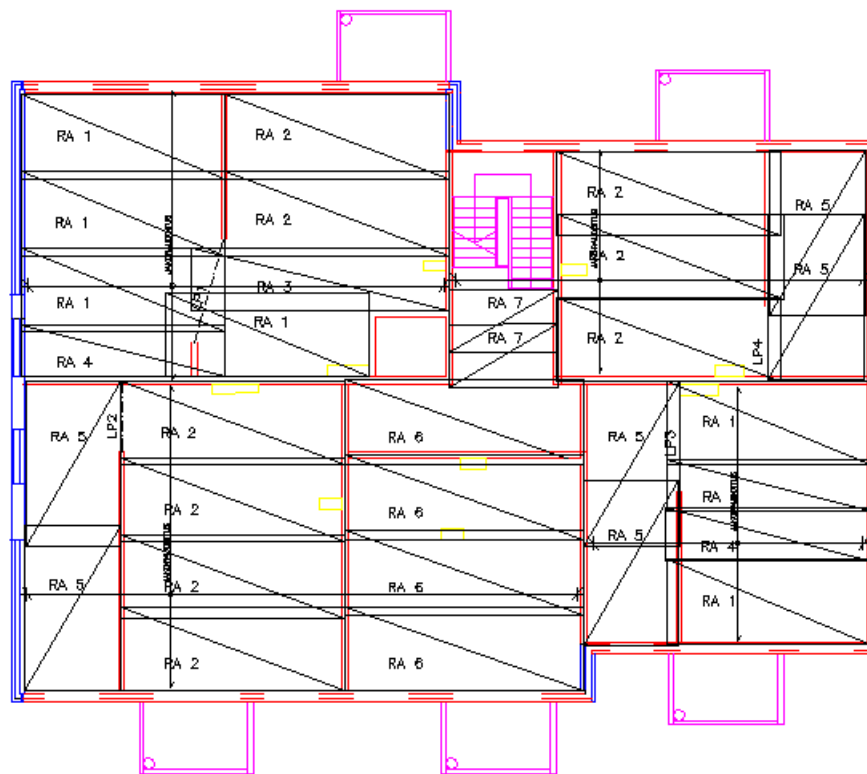

FIG 168 Bottom slab reinforcement

The in situ slabs are usually reinforced by meshes.

YLÄPINNAN RAUDOITEET

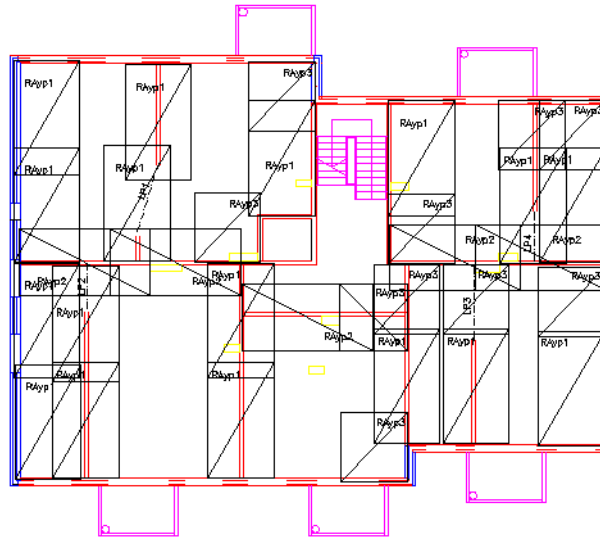

FIG 169 Top reinforcement meshes

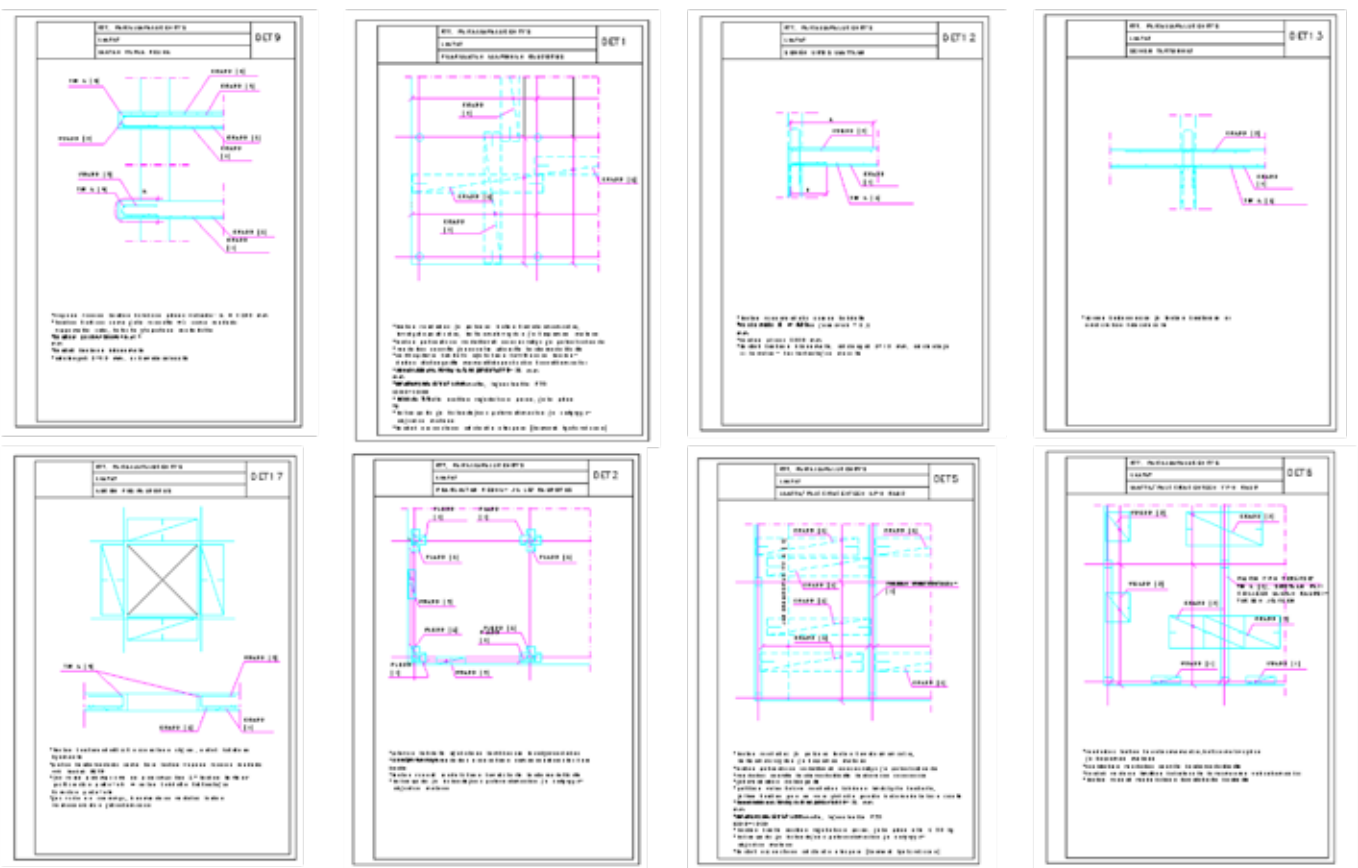

FIG 170 In situ reinforcement details /5/

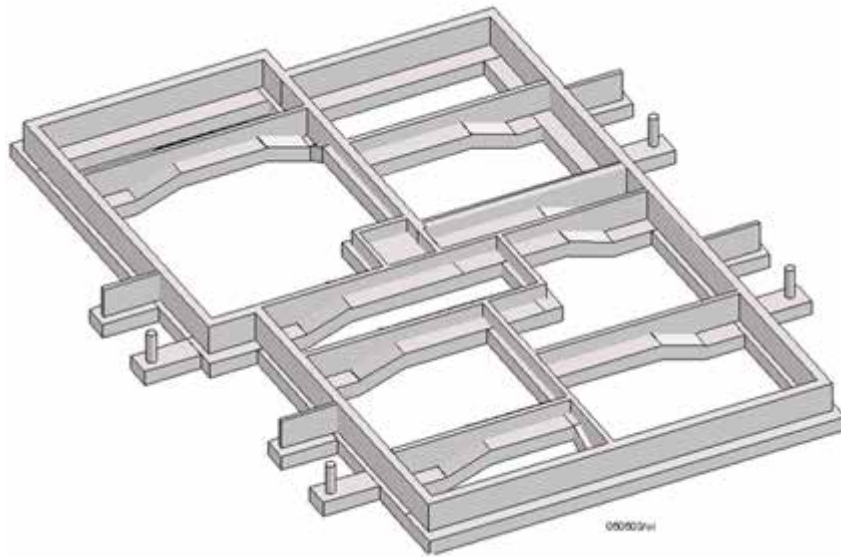

FIG 171 *In situ foundations*

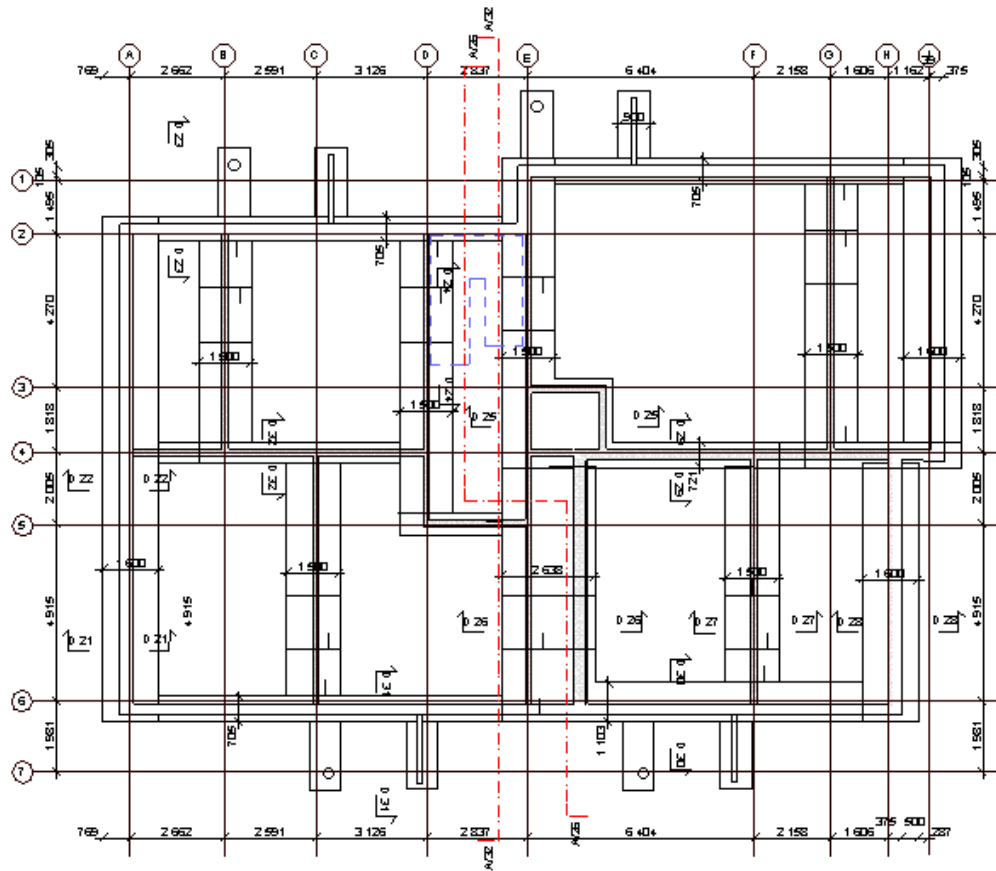

FIG 172 In situ foundations

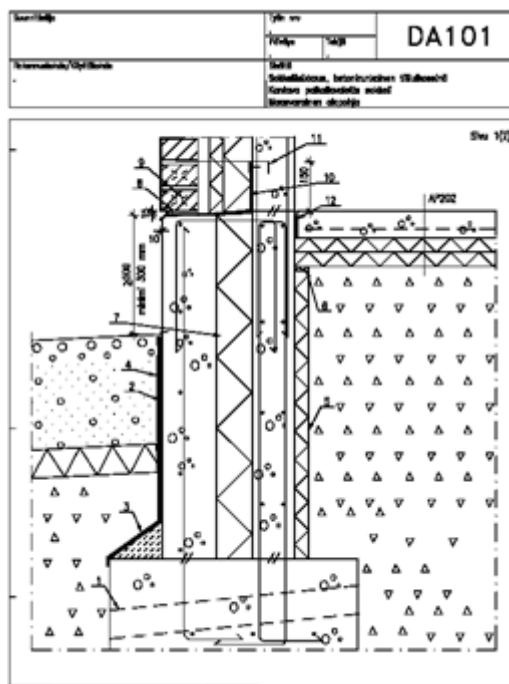

FIG 173 Foundation detail



FIG 174 In situ frame

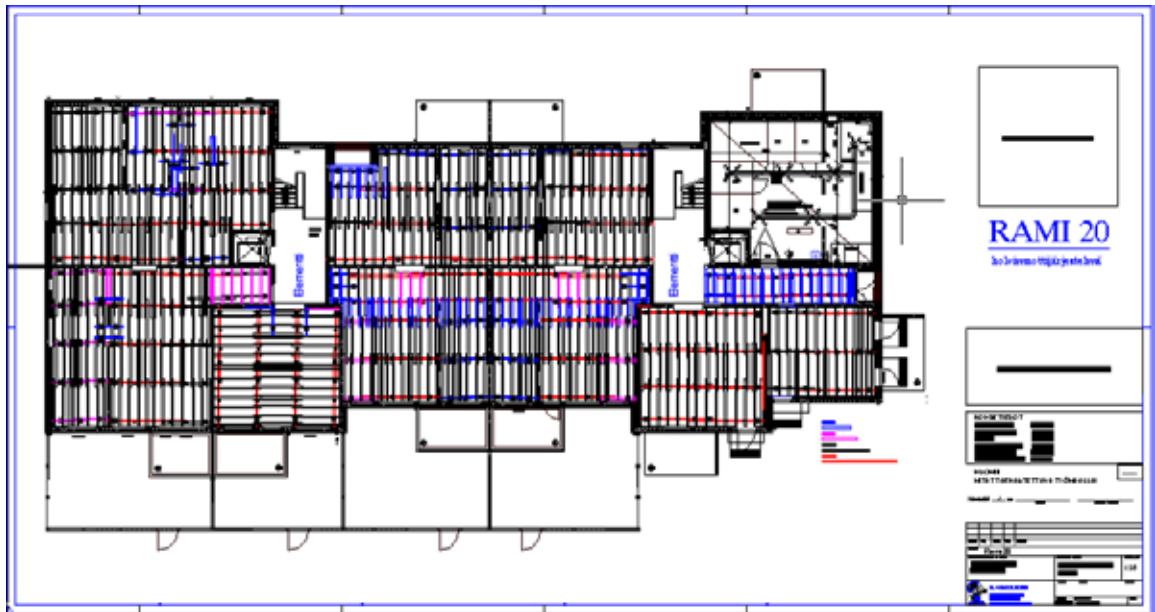

FIG 175 Rami Mould- layout

8 Steel Construction

/7/ Teräsrakenteiden Suunnittelu ja Mitoitus

Structural Steel Profiles

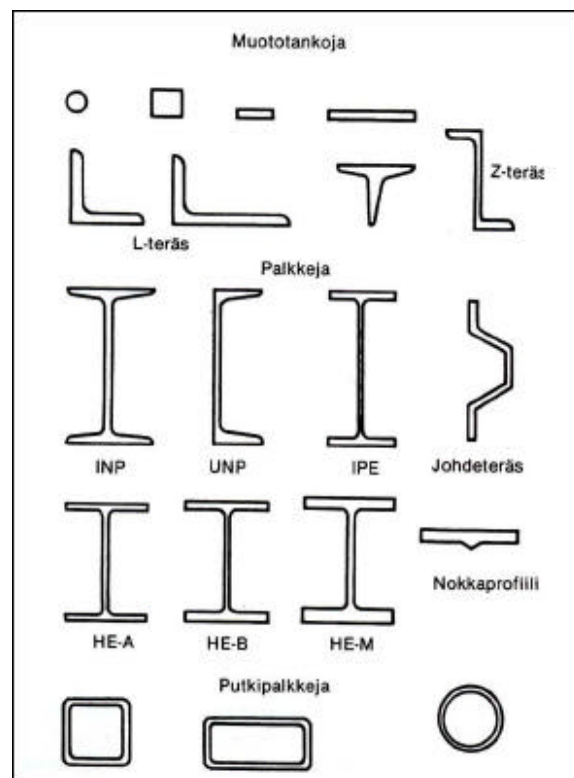

FIG 176 Hot rolled profiles /7/

The hot rolled profiles and plates are most widely used structural steel products. The products can be divided to bars, beams and hollow section beams. The first group includes circle, rectangular and L-, T- and Z- shape bars. The beams include I- and U-shape beams. The most common hot rolled I beams are HE-A-, HE-B- and H-M-profiles. HE-A is the lightiest and HE-M the heaviest. Correspondingly HE-A has the smallest section modulus.

In addition there are a number of special sections. These include the sheet piling, various kinds of guard rails and welded beams. The material can be ordinary structural steels or special steel qualities. The exact dimensions can be found in existing standards and catalogs.

Tubes, pipes and hollow sections

The hollow shape, small weight and excellent strength properties make hollow section structures efficient and affordable. They are very competitive in trusses because of their torsion and bending capacities. The hollow sections can be manufactured either by hot-roll or welding method. The hollow sections are made of general steel grades as well as of a variety of weather-resistant steels. The size range is very wide. The largest so-called. Jumbo RHS beams have dimensions of 800 x 800 mm².

The Welded Profiles

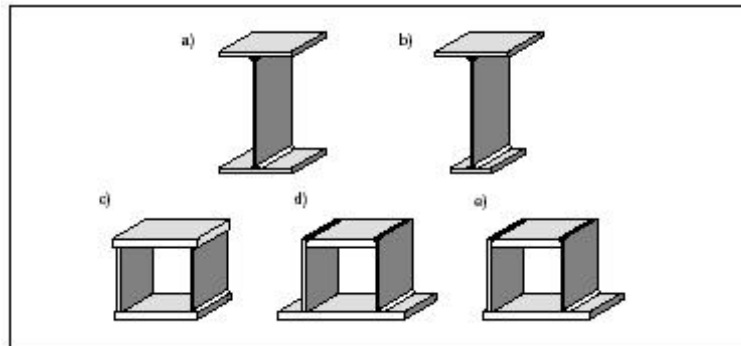

FIG 177 General welded profiles /7/

The technological development has made it possible to produce competitive welded beams. The undeniable advantage compared with the hot rolled profiles is the opportunity to reformulate the cross-sectional more freely. A considerable material saving can be achieved by optimizing e.g. I- beam web and flanges in such a way that a desired capacity is achieved with the smallest material use. The welded box beams have proven to be competitive since they are especially suitable with hollow-core slabs e.g. WQ- and Delta- beam.

The Cold Formed Profiles

Cold-formed sections have been used to a bigger extend in recent years as roof and wall pur-lins. The lightness and variety of profiles are clear advantages compared with the traditional solutions. Profiles are also available galvanized or coated with plastics.

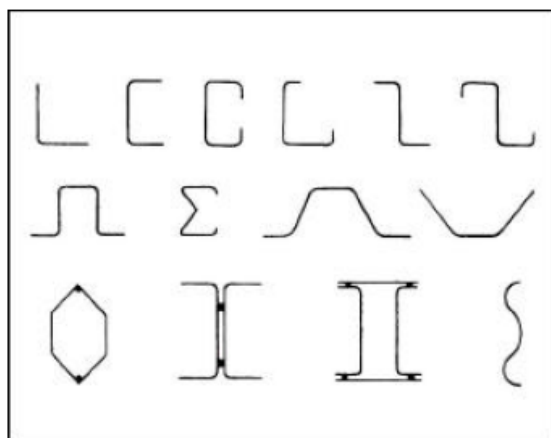

FIG 178 Cold formed profiles /77

The cold formed profile's strength class is usually S235, S275 or S355 and the profiles are divided to standard profiles and custom made profiles. Typical roof profile is e.g. Z- 250-3 S350 which is 250 mm high, material thickness 3 mm and the steel S350.

Corrugated plates

As the hot roll technique's minimum thickness is 3 mm the thinner plates are cold formed. The 3 mm thick material is transferred as rolls and then cold formed to a thickness 1 mm or even less. The cold form process increases the steel's strength but makes it more brittle.

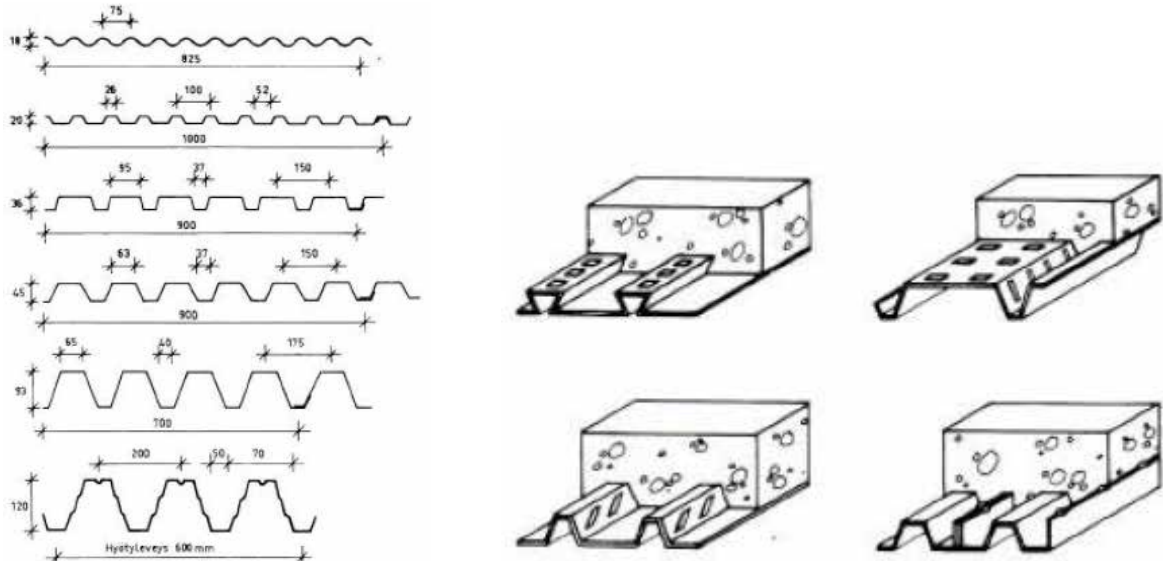

FIG 179 Corrugated plates /7/

The plate is usually galvanized and coated with plastic paintings. The treated plate is delivered to the customers which use the product as itself or process it to different kinds of profiles or corrugated plates for wall or roof sheetings or purlins. The corrugated plates are used in combination slab structures too.

Steel Frames

The steel frame must maintain its stability. To ensure the stability it must be ensured that the buckling is not possible. The frame components must therefore be dimensioned sufficiently stiff and the entire frame system must be braced.

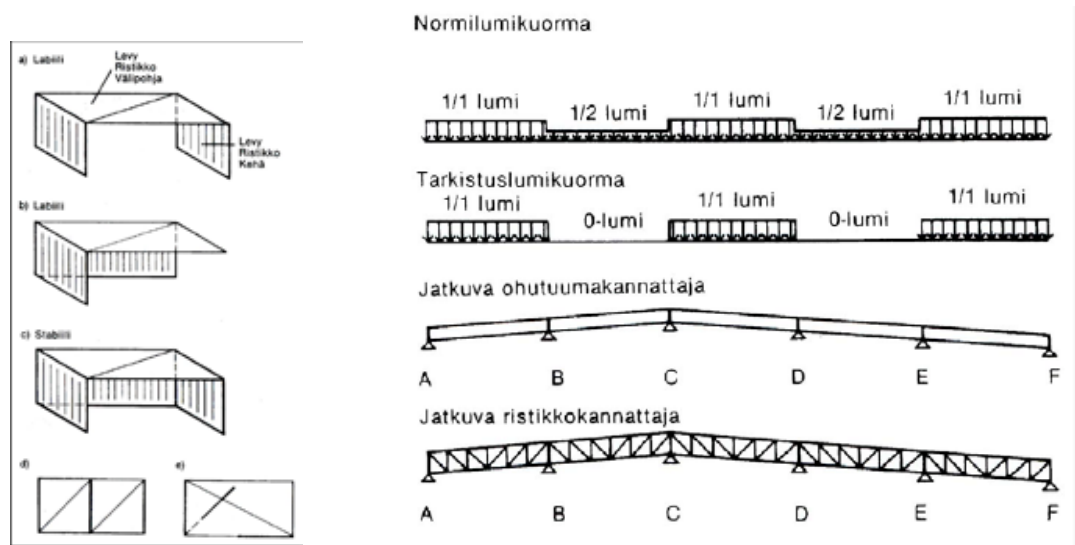

FIG 180 Steel frame bracing and load combinations /7/

In the Pre- Design the final solution is chosen among the different available frame solutions. As the hyperstatic systems designed the sections has to be chosen in advance.

The Steel Frame Bracing System

The bracing systems can be categorized in three basic structures:

- diaphragm i.e. a plate with shear capacity
- stiff corner connections
- truss

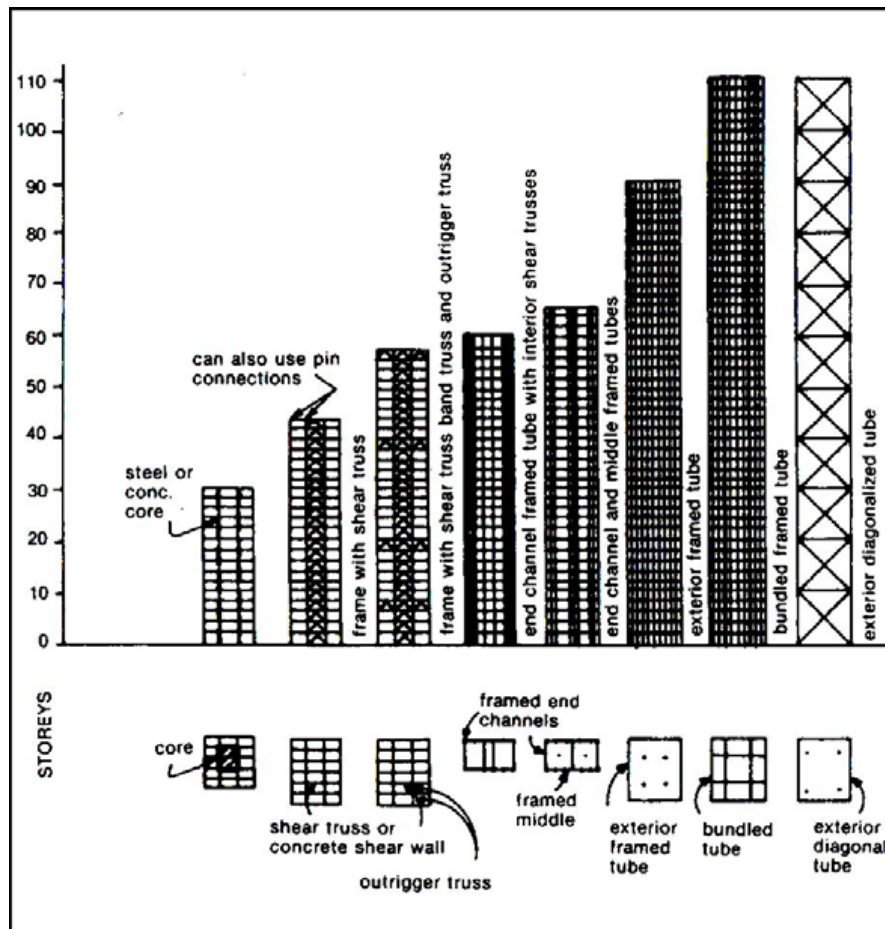

FIG 181 Bracing of the high rise buildings /7/

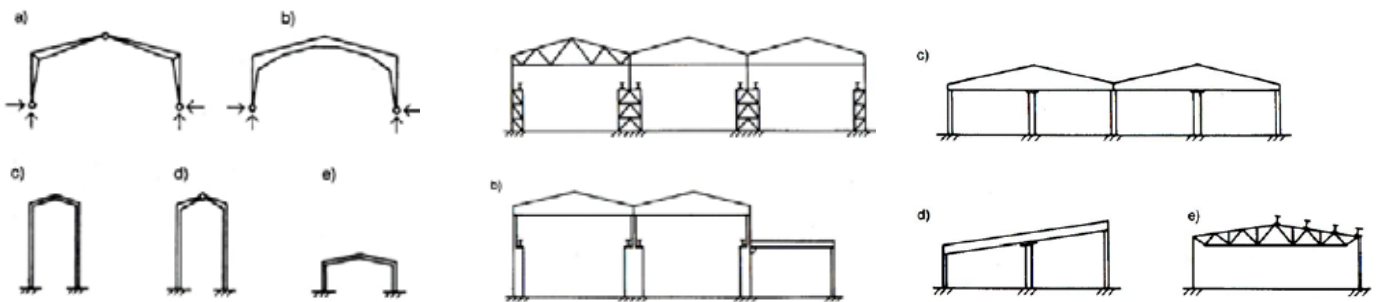

FIG 182 Typical Portal Frame systems /7/

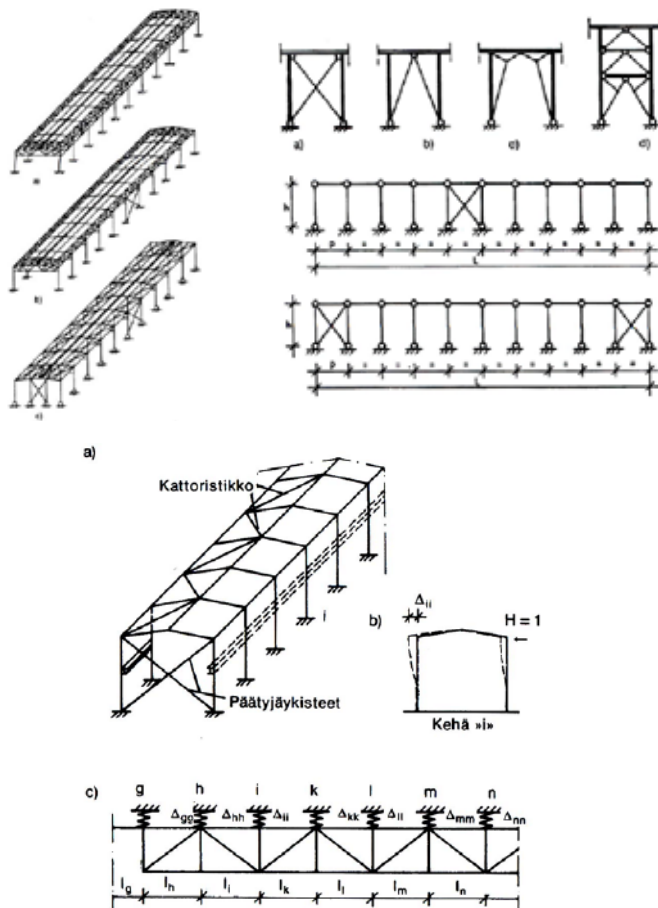

FIG 183 Bracing with trusses /7/

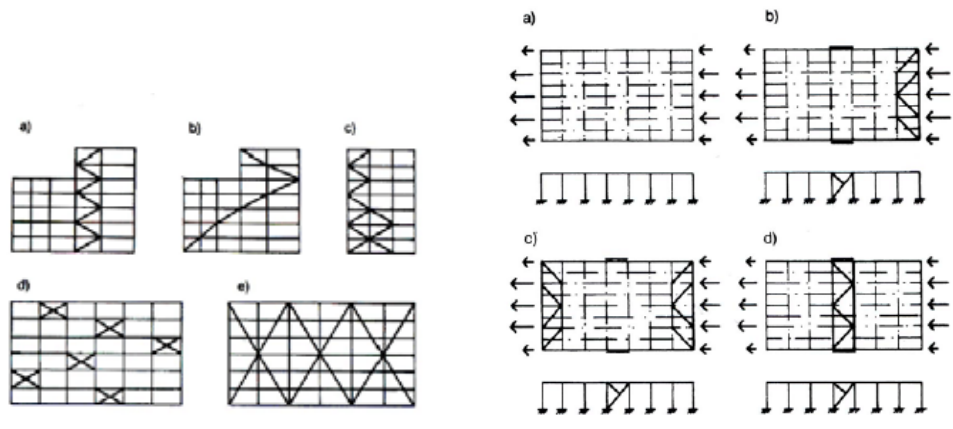

FIG 184 Truss bracing in high rise buildings /7/

Steel Frame Designs

/8/ Demohalli – opiskelijaprojekti

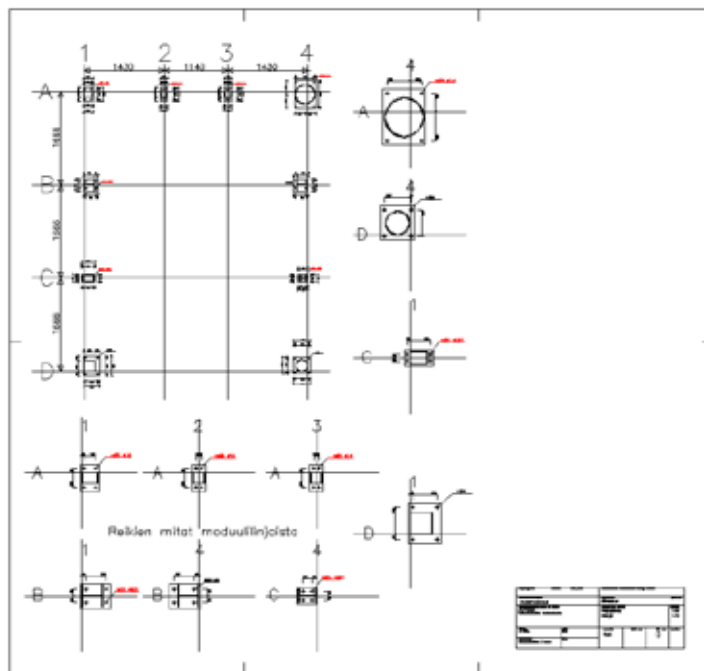

FIG 185 Steel Frame Floor Plan

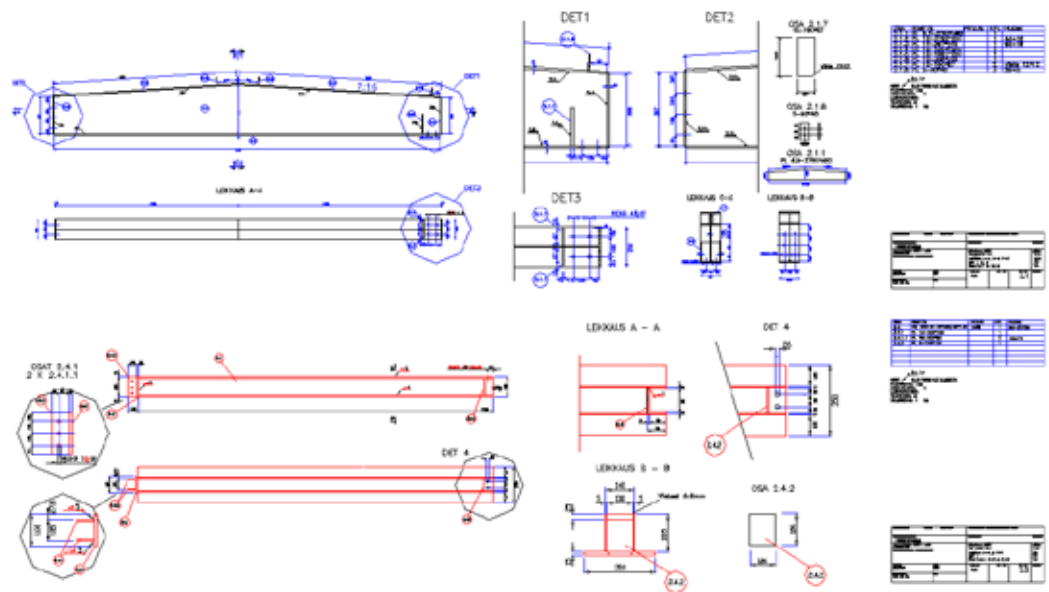

FIG 186 Assembly Drawing

9 Timber Construction

The timber structures are designed according to the SFS EN 1995-1 and 2. The EN 1995 is applied both in building as well as in civil engineering works as timber, sawn timber, planed wood or logs, gluelam or construction products such as LVL or wooden boards are in use. The standard follows the structural reliability and the criterias set out in the standard EN 1990:2002.

EN 1995 applies only to timber mechanical durability, usability, stability and fire resistance requirements. Other requirements, such as thermal insulation or soundproofing are not presented Typical applications include timber frame houses, multi-storey timber frame residential houses and production and commercial buildings.



FIG 187 Multi-Storey Timber Residential House /10/ /11/



FIG 188 Gluelam Portal Solutions /10/ /12/



FIG 189 Timber Frame Single Occupancy

9.1 Gluelam Structures

/15/

The gluelam section is usually made with 45 mm thick wood glued together. The gluelam has better strength values as sawn timber and longer spans can be achieved with it.

A German patent in 1906 (Hetzer Binder) was a real modern gluelam production's start date. Sweden's one of the first glulan structures can be found in the railway station waiting halls in Stockholm, Gothenburg and Malmö in the 1920s. Finland's first glued wooden structures were ship structures delivered to Russia as the war compensation.

The gluelam frame system can have many solutions. The portal frames can be simple cantiliver column- beam systems or advanced shell structures.



FIG 190 Gluelam Portal Frame /15/

A portal frame can be built economically with the gluelam frame and e.g. LVL-rib- roof-elements. The LVL-rib roof-elements are prefabricated products with which the building can be weather- protected. The roof-elements are equipped with roofings and thermal insulation and can achieve the REI60 fireclass and are therefore especially suitable for the commercial- and production building.

Gluelam structures

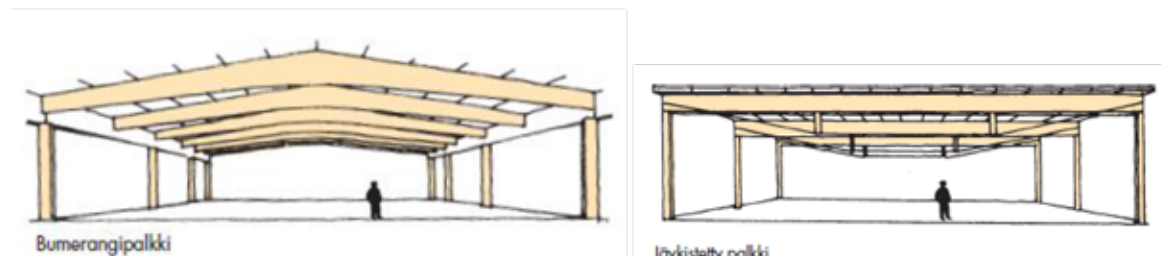

FIG 191 Gluelam Frame solutions /15/

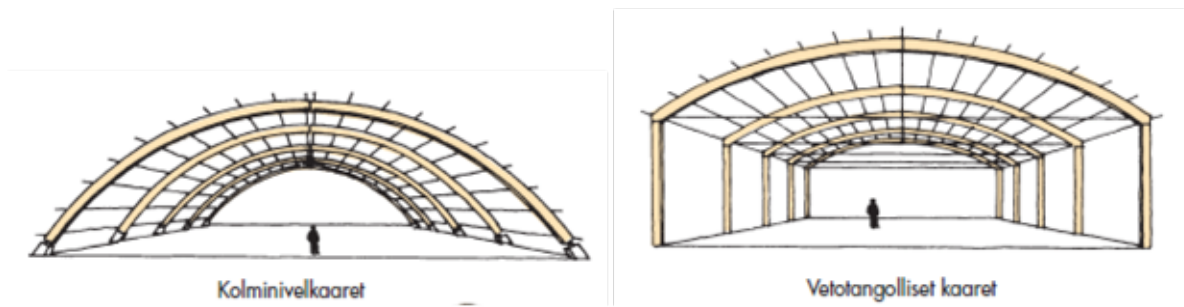

FIG 192 Glulam Frame solutions /15/

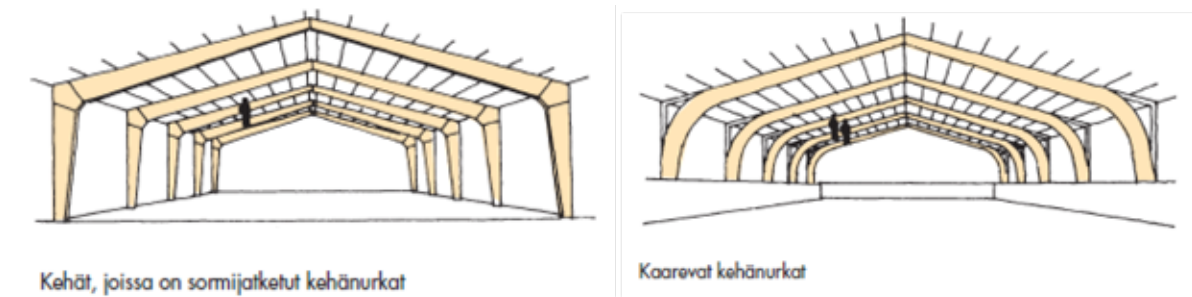

FIG 193 Glulam Frame solutions /15/

Systeemi	Kuvaus	Sopiva katto- kaltevuus	Sopiva jänneväli (m)	Poikkileikkaus- korkeus
	Suora kaksitukinen palkki	$\geq 3^\circ$	< 30	$h \sim \frac{l}{17}$
	Suora alapuolelta jäykistetty kaksitukinen palkki	3-30°	< 50	$h \sim \frac{l}{40}$ $H \sim \frac{l}{12}$
	Kaksitukinen harjapalkki (pulttippalkki)	3-10°	10-30	$h \sim \frac{l}{30}$ $H \sim \frac{l}{16}$
	Kaksitukinen bumerangipalkki	3-15°	10-20	$h \sim \frac{l}{30}$ $H \sim \frac{l}{16}$
	Suora jatkuva palkki	$\geq 3^\circ$	< 25	$h \sim \frac{l}{20}$
	Suora viisteellinen jatkuva palkki	$\geq 3^\circ$	< 25	$h \sim \frac{l}{24}$ $H \sim \frac{l}{16}$
	Kaksitukinen ulokepalkki	< 10°	< 15	$h \sim \frac{l}{10}$
	Suora kaksitukinen ristikkopalkki	$\geq 3^\circ$	30-85	$h \sim \frac{l}{10}$
	Kohtisuora palkkiarina	$\geq 3^\circ$	12-25	$h \sim \frac{l}{20}$ ($a = 2,4 - 7,2$ m)

FIG 194 Glulam Frame solutions /15/





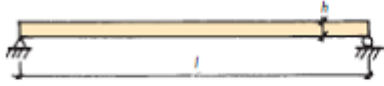
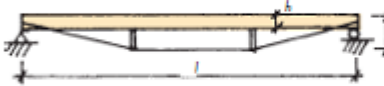
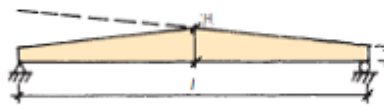
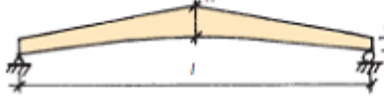
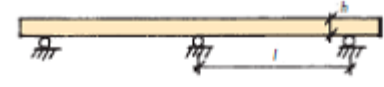
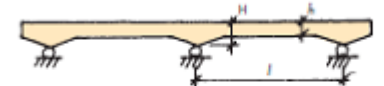
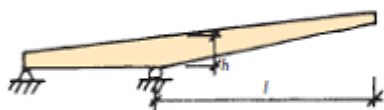
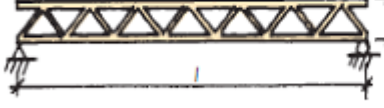
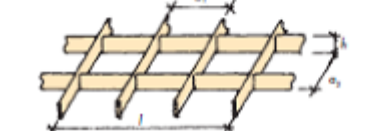

Systeemi	Kuvaus	Sopiva kattokaltevuus	Sopiva jänneväli (m)	Poikkileikkauskorkeus
	Kolminivelkattotuoli vetotangolla tai ilman	$\geq 14^\circ$	15 - 50	$h \sim \frac{l}{30}$
	Vetotangollinen kolminivelkattotuoli alapuolisin jäykistein	$\geq 14^\circ$	20 - 100	$h \sim \frac{l}{40}$
	Kolminivel- (kaksinivel-) kaari vetotangolla tai ilman	$\frac{f}{l} \geq 0,14$	20 - 100	$h \sim \frac{l}{50}$
	Kolminivelkehä sormijätketulla kehänurkalla	$\geq 14^\circ$	15 - 25	$h \sim \frac{s_1+s_2}{13}$
	Kolminivelkehä yhdistetyllä kehänurkalla	$\geq 14^\circ$	10 - 35	$h \sim \frac{s_1+s_2}{15}$
	Kolminivelkehä kaarevalla kehänurkalla	$\geq 14^\circ$	15 - 50	$h \sim \frac{s_1+s_2}{15}$
	Puolikehä nivelpilarilla	$\geq 20^\circ$	10 - 25	$h \sim \frac{l}{25}$
	Hyperboloidinen paraboloidikuori (HP-kuori)	$\frac{f_1+f_2}{l_1+l_2} \geq 0,2$	$l_1 \sim l_2$ 15 - 60	$h \sim b \sim \frac{l}{70}$ (reunapalkit)

FIG 195 Glulam Frame solutions /15/

Kuormitus [kN/m]	Leveys [m]	Palkki BxH1xH2	Päätypalkki BxH	Pääpilarit BxH, M	Nurkkapilarit BxH, M	Tuulipilarit BxH, M
19	16	165	140	165	165	140
		675	225	450	315	225
		1175		24	30	20
19	20	165	140	165	165	140
		855	270	450	315	225
		1480		24	30	24
19	24	190	140	190	165	140
		945	315	450	315	225
		1695		24	30	24
19	28	215	165	215	165	140
		1035	315	450	360	270
		1910		30	30	24
23	16	165	140	165	165	140
		810	225	495	360	225
		1310		30	30	20
23	20	190	140	190	165	140
		945	270	450	315	225
		1570		30	30	24
23	24	190	140	190	165	140
		1125	315	495	360	270
		1875		30	30	24
23	28	215	165	215	165	140
		1215	360	495	360	270
		2090		30	30	24
28	16	165	140	165	165	140
		900	225	495	405	225
		1400		30	30	20
28	20	190	140	190	165	140
		1035	270	495	405	225
		1660		30	30	24
28	24	215	140	215	165	140
		1170	315	495	405	270
		1920		30	30	24
28	28	240	165	240	165	140
		1305	360	495	405	270
		2180		30	30	24
33	16	190	140	190	165	140
		900	225	540	405	225
		1400		30	30	20
33	20	190	140	190	165	140
		1170	315	540	450	225
		1795		30	30	24
33	24	215	165	215	165	140
		1305	315	540	450	270
		2055		30	30	24
33	28	265	165	265	165	140
		1395	405	495	450	270
		2270		30	30	24

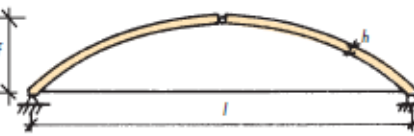
Mitoitustaulukko 9.1 Pääkannattajana lp-harjapalkki. Kuormitus 19/23/28/33 kN/m ($=p_d$); hallin leveys 16/20/24/28 m; taulukossa tulosteena pääkannattajan leveys (B), päätykorkeus (H1), keskikorkeus (H2); päätypalkin mitat (B, H); pää-, nurkka- ja tuulipilarin mitat (B, H) ja peruspultin koko (M). Samoilla äärimitoilla voidaan arvioida kertopuurlinjan tilantarvetta.

FIG 196 Glulam Frame Capacity Table /16/

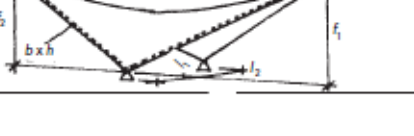
The Glulam Beam Design

Check the Example Calculations /13/

Basic information of the beam

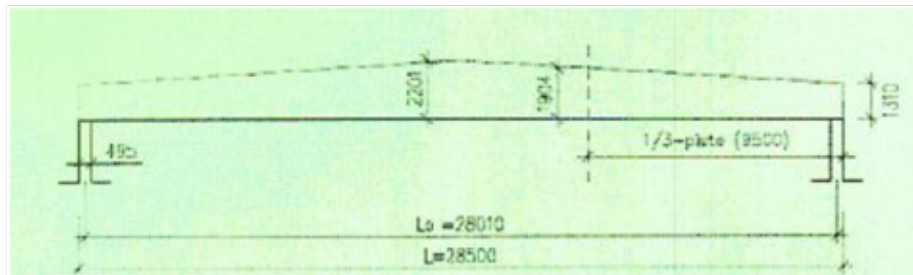

$L := 28500$ mm

The length of the beam

$L_0 := 28010$ mm

The span of the beam

$h_1 := 1310$ mm

The support height

$h_{ap} := 2201$ mm

The apex height

$h_m := 1904$ mm

The beam height at $1/3$ distance

$b := 240$ mm

The beam breath

$h_c := 495$ mm

The column height

FIG 197 Glulam Beam Design

Glulam Column design

Check the Example Calculations /13/

Mastopilarin mitoitus

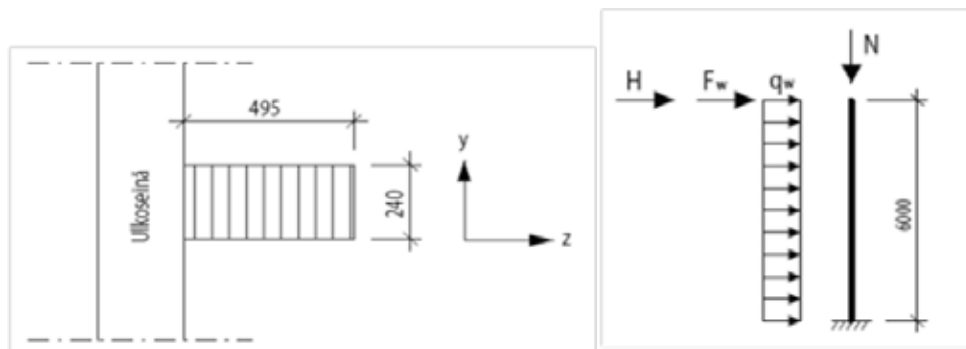
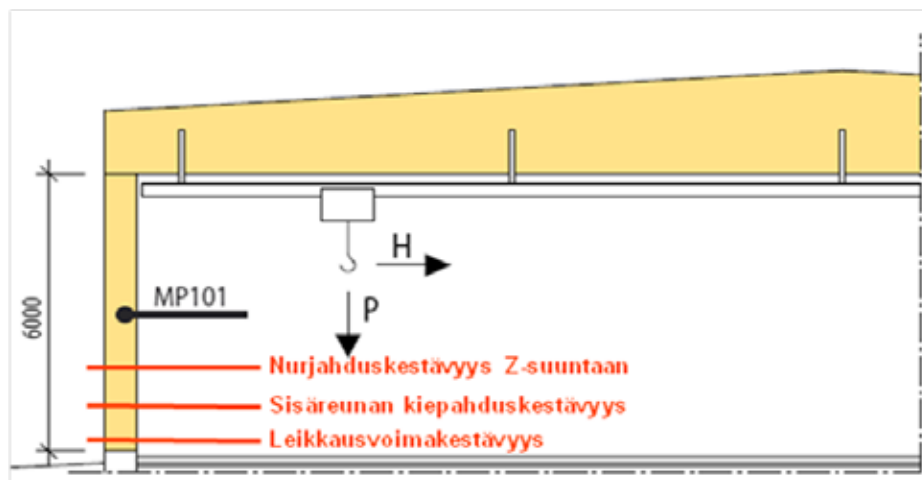

FIG 198 The Glulam Column Design

9.2 The Timber- Frame Multi-Storey Residential Houses

The Timber-Frame Multi-Storey Residential Houses can be constructed using e.g. the Platform-Technique, the Column-Beam-Frame Technique or the CLT CrossLaminated Timber technique. The PuuBES – Research is standardizing the timber unit Construction.

The Plattform-technique

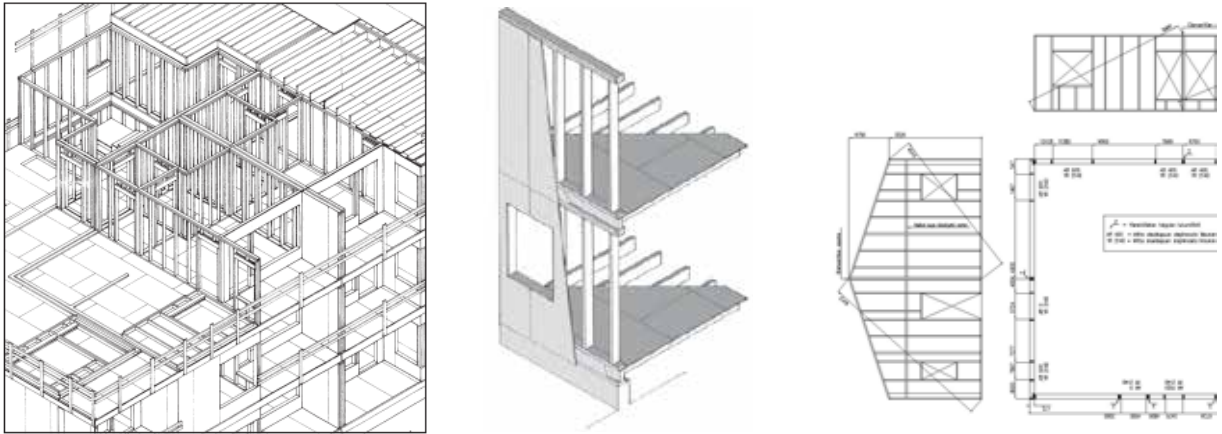

FIG 199 Plattform Frame /15/

The frame is constructed storey by storey. The intermediate floors serve as work platforms where the walls are built horizontally and lifted up to their places. The Plattform technique is used in one storey buildings as well. After the frame the roof and external walls are installed. The HVAC technique is built after the frame. The Plattform technique can be used in prefabricated solutions as well. /15/

Column- Beam Frame

The frame is built with LVL- columns and beams. The base and roof structures can be made with LVL-rib beams and walls can be built with big prefabricated units.



FIG 200 Column-Beam Frame Multi-Storey Residential House /10/

- Kertopuinen pilari-palkkirunko
- Massiiviset Kertopuiset mastojäkisteet
- Rakenteellisesti liimatut Kerto-RIPA välipohjaelementit
 - Perusleveys 1800, 2500 mm
 - Jännemitat 5...8 m
- Kevyet ulkoseinäelementit
 - Kuningaspaneeli (tai muu puuverhous)
 - Rappaus
 - Paikalla muuraus

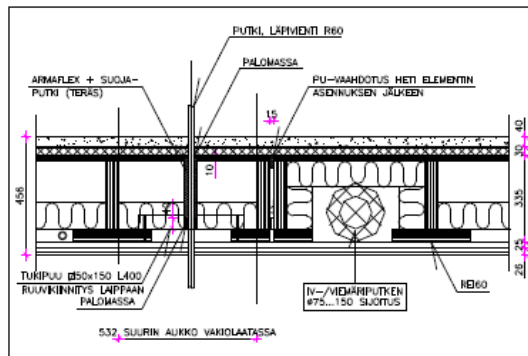
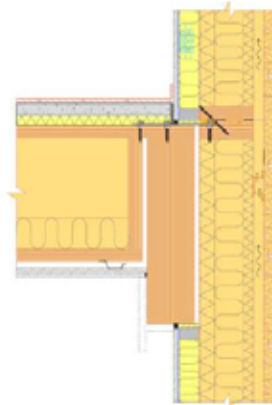

FIG 201 Frame System and the HVAC technique /10/

CLT – Timber Frame Multi-Storey Residential House

/11/

The frame can be built with CLT-panels as well.



FIG 202 CLT- Frame /11/

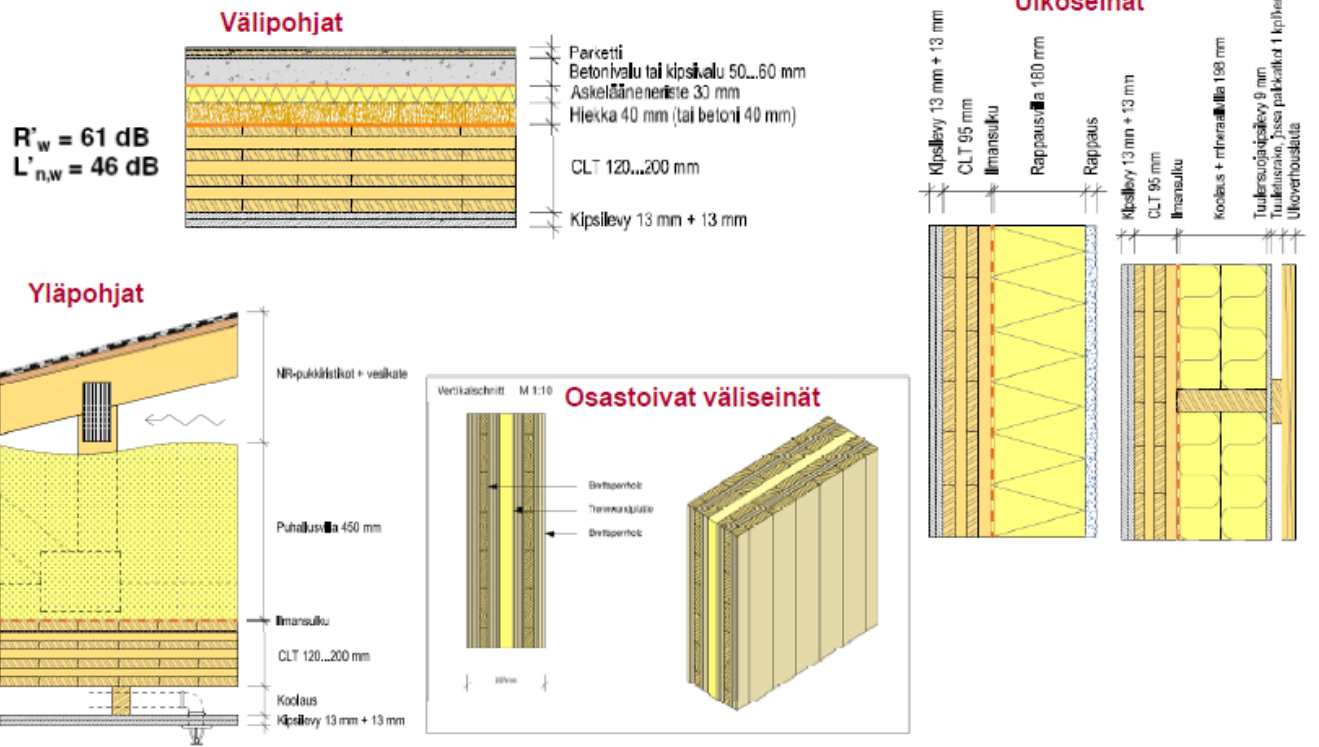

FIG 203 CLT- Frame Details /11/

9.3 Big Timber Structures

/12/

The big timber structures are used in e.g. public buildings, commercial- and sportbuildings. The primary structure can be e.g. a glulam beam or a LVL-truss.



FIG 204 Sibeliustalo /12/



FIG 205 Asikkala Iceskate – hall /12/



FIG 206 Storage in Tampere /12/



FIG 207 Sutiranta bridge /12/



FIG 208 *Glulam designs*

10 Masonry Houses

10.1 Masonry

/5/ www.kivitalo.fi



FIG 209 Bricks and blocks /5/

There is available different kinds of products to mason structures; natural stone, burnt brick, compressed sandbrick and different blocks.

Brick facade is durable and maintenance-free. Weather resistance is a absolute quality requirement and it is monitored through regular tests. There is a big selection of different bricks available both in the colors, surfaces as the sizes. The normal brick size is 130 x 75 x 270 mm and the module brick size is 85 x 85 x 285 mm.

The burnt clay brick is usually used in facades and the compressed sand bricks and blocks are more common in partition walls. The brick and block walls are either masoned or glued. In addition of the traditional bricks special bricks and blocks are available for foundations, partition walls, beams and flues.

The mortars are divided in different classes depending the ratio of lime and cement. Other raw materials are sand and water. The oldest mortars were pure lime mortar. Mortar and plaster were first added cement in Finland in the 1880s. At present the so called dry mortar including the aggregate and only water is added is the most common practise. Mortar manufacturing in situ is very seldom. Mortar is made for many purposes such as bricks and masonry blocks, plastering and tiling. In addition, special mortars are manufactured for fireplace masonry.

Mortar properties such as strength, adhesion, resistance to frost and the color and the spreadability vary a great deal depending on the purpose. The block gluing has been more common technique recently. In that case the mortar layer (adhesive layer) is a thickness of less than 5 mm.

10.2 In Situ Frames

The in situ frame differs from the others especially as for the production technique. but as well

The in situ frames can classified after the bearing vertical structures as follows:

- the bearing walls
- the bearing columns
- the bearing walls and columns

The floor structures may be

- flatslab
- slab with ribs
- cell slab

The horizontal in situ structures can be built either as normal reinforcement structures or as prestressed structures. The prestressed structures enables long spans and slender columns.

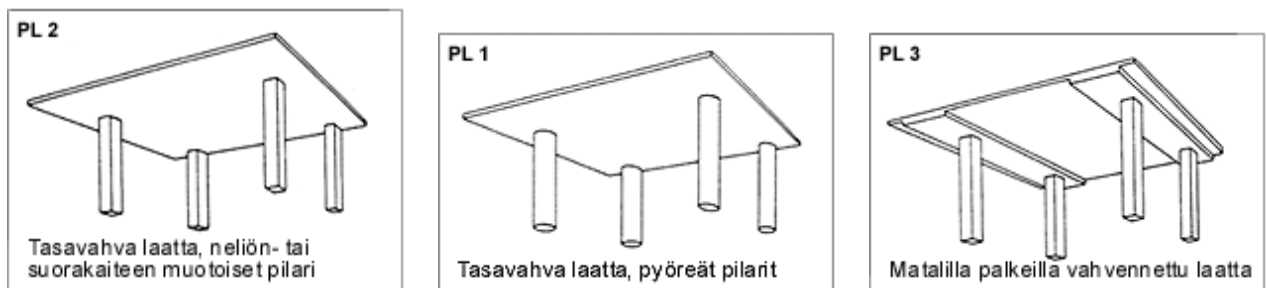

FIG 210 Column Slab Frames /5/

Especially the office and commercial buildings have one or more frame solutions. This usually the case as a parking hall is built next to the office building.

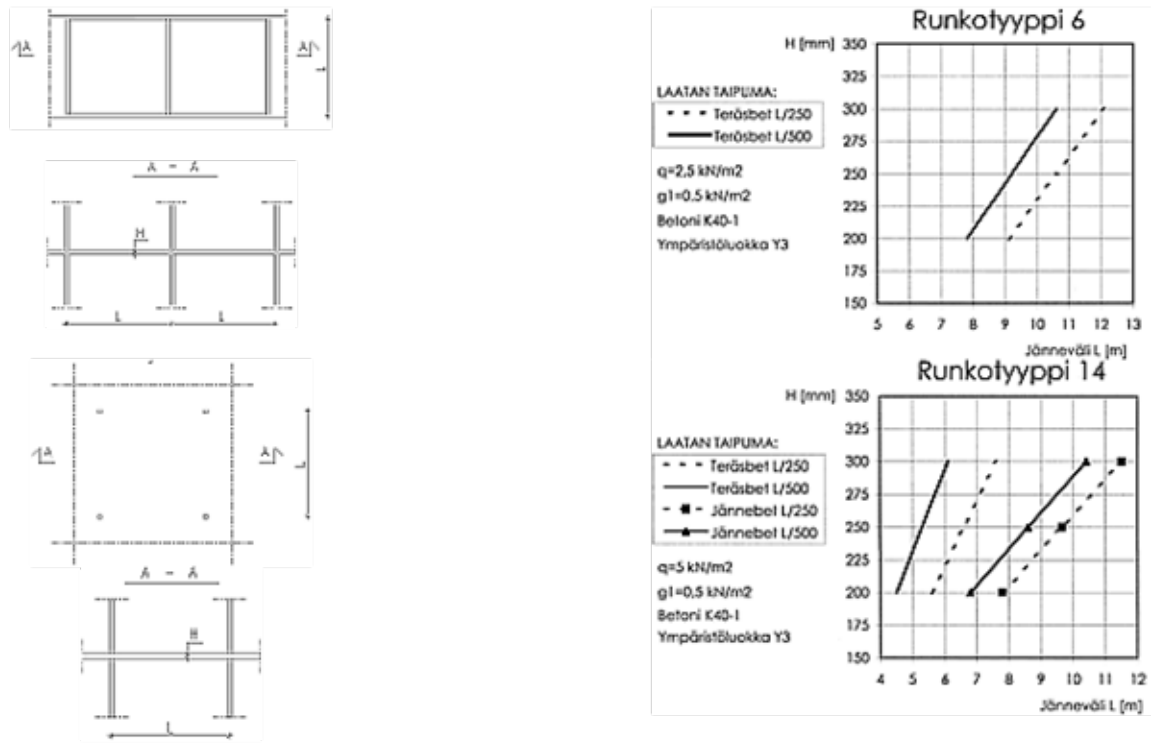

FIG 211 In Situ Multi-Storey Residential House Frame PreDesign curves /5/

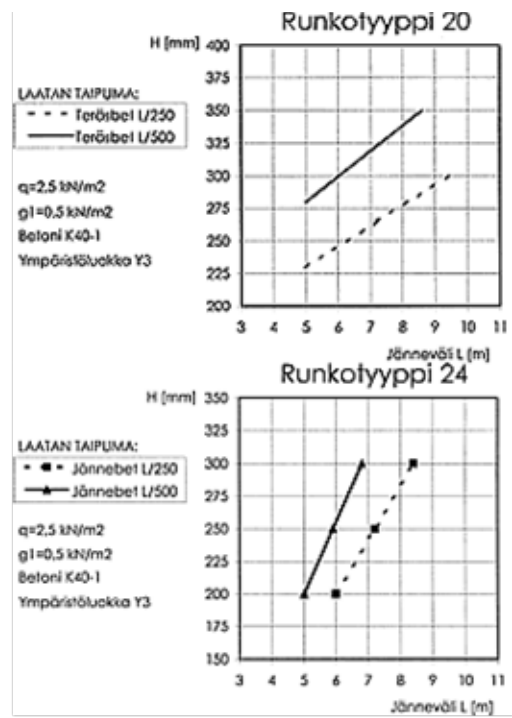
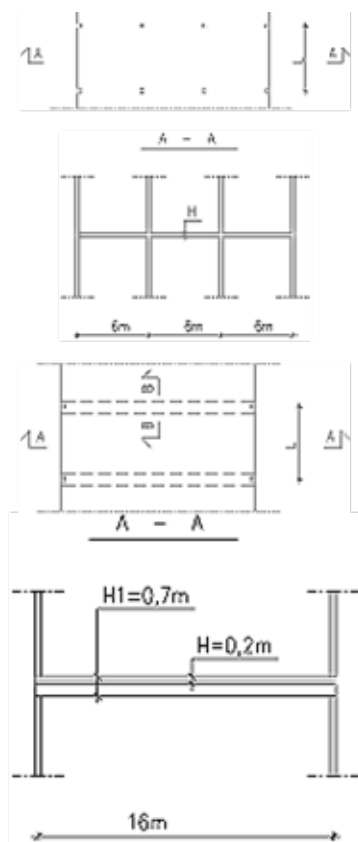

FIG 212 In Situ Commercial Building Frame PreDesign curves /5/

11 Combination Structures

/17/ ESDEP

The combination of concrete and steel is the most common practise in multi-storey office- and commercial houses as well as in the bridges. The steel columns and beams filled with concrete are typical combination structures. In multi-storey houses the frame can be made of combination structures and the floors are often in situ or hollow core slabs. The combination structures can enable more effective and economical solutions.



FIG 213 Combination Frames in London and in Germany /17/

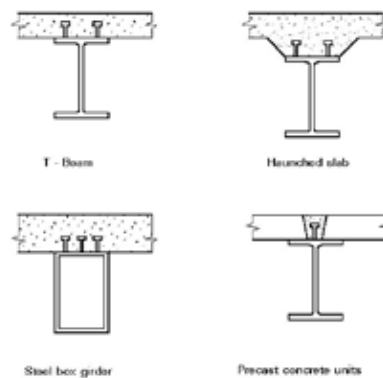

Figure 3 Typical beam cross-sections

FIG 214 Combination Beams /17/

The figure presents different combination beams.

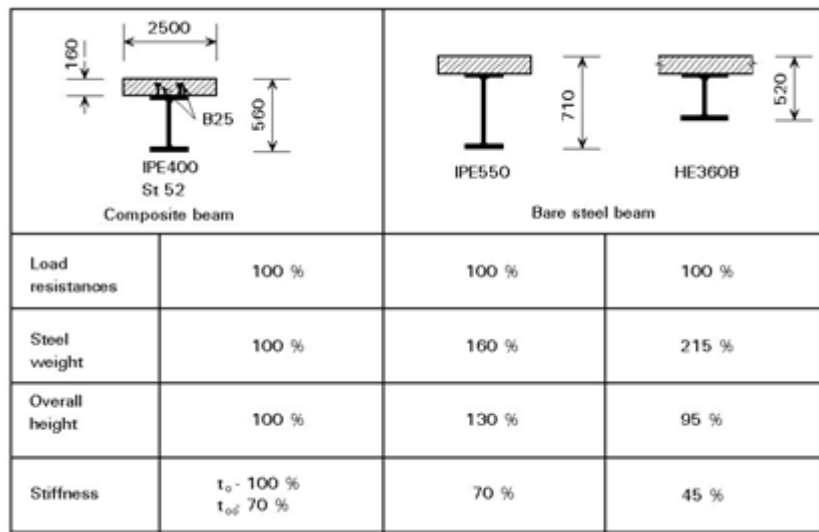

FIG 215 The comparison of Steel Beams and the Combination Beams /17/

The combination structures have some advantages. The capacity is bigger and smaller sections can be used. This means material savings, smaller storey heights and lower costs.

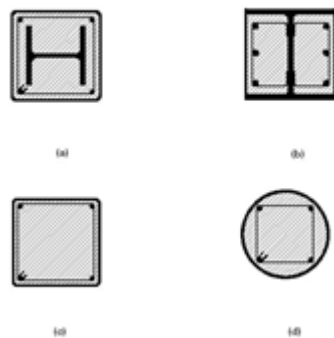

FIG 216 Combination columns /17/

There are mainly three types of combination columns:

- steel columns surrounded by concrete
- steel columns filled with concrete
- hot rolled steel columns filled with concrete

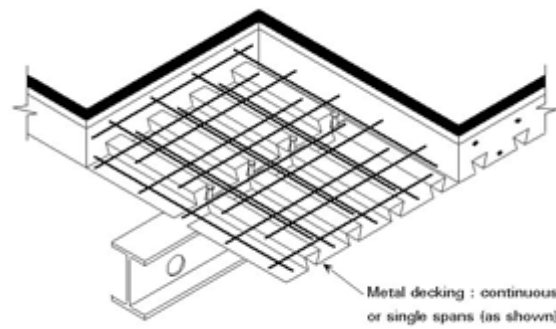

FIG 217 *Combination slab /17/*

The combination slab consists of a corrugated plate with anchors and concrete is casted on it. As the concrete hardens the combination effect is born. .



FIG 218 *Peikko Combination Frame /17/*

12 References

- 1 www.amk.fi
- 2 www.puuinfo.fi
- 3 www.ymparisto.fi
- 4 www.stukes.fi
- 5 www.kivitalo.fi
- 6 www.elementtisuunnittelu.fi
- 7 Teräsrakenteiden Suunnittelu ja Mitoitus TRY ry
- 8 Demohalli -student project Hamk 1996
- 9 The residential Houses Example Calculations
- 10 Finnforest www.finnforest.fi
- 11 StoraEnso www.storaenso.fi
- 12 Versowood www.versowood.fi
- 13 The Gluelan Portal Frame's Example Calculations
- 14 STEP 1,2 Structural Timber Education Programme
- 15 Glulam Handbook
- 16 The Timber Portal Frames Guide www.puuinfo.fi
- 17 ESDEP
- 18 Organization and Use of Project Information Hendrickson C Carnegie Mellon
- 19 www.rakennustieto.fi
- 20 Builder's Foundation Handbook
- 21 www.paroc.com
- 22 www.wikipedia.fi
- 23 Handbook of Production Planning and Management on a Construction Project
Hannu Koski TUT
- 24 <http://virtual.vtt.fi/virtual/proj6/proit/>

13 Annexes

Steel Frame Drawings

Annex 1

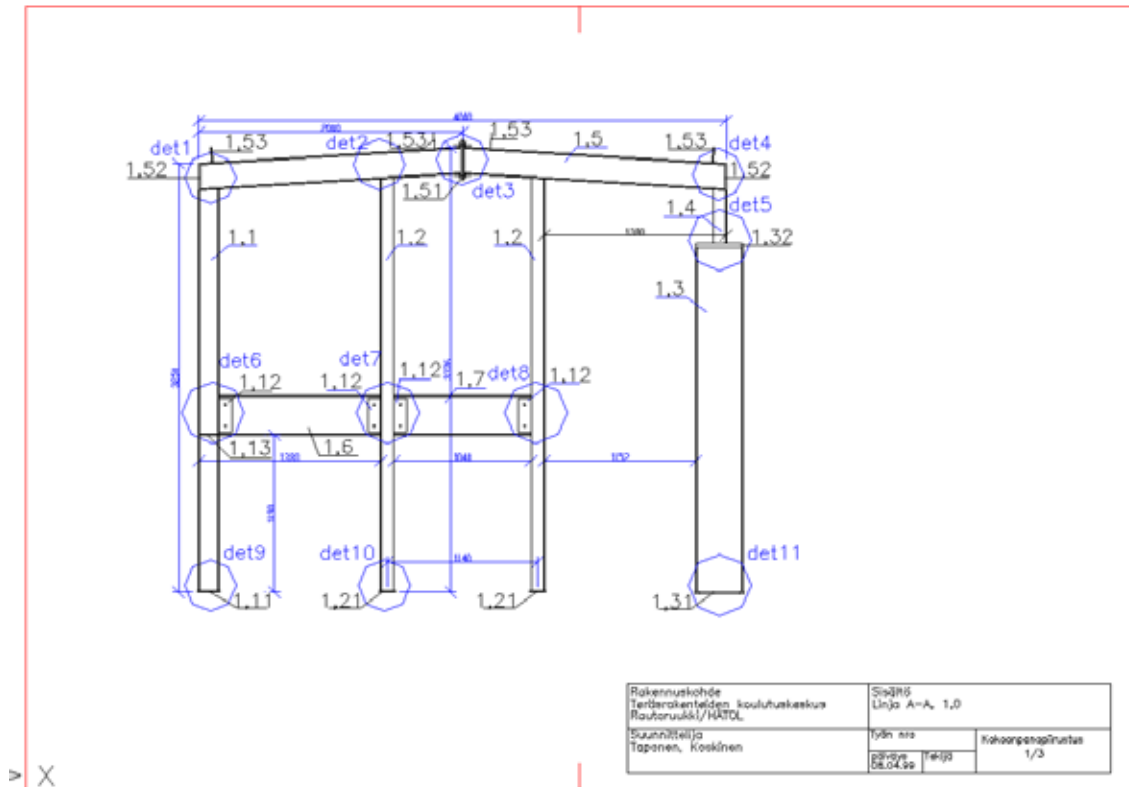

Section Drawing

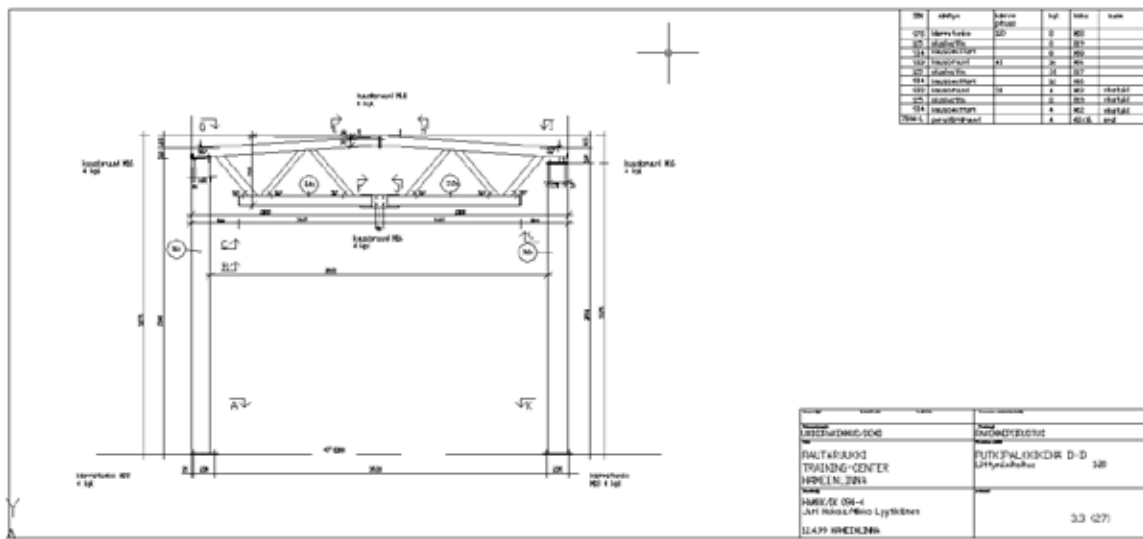

Section Drawing

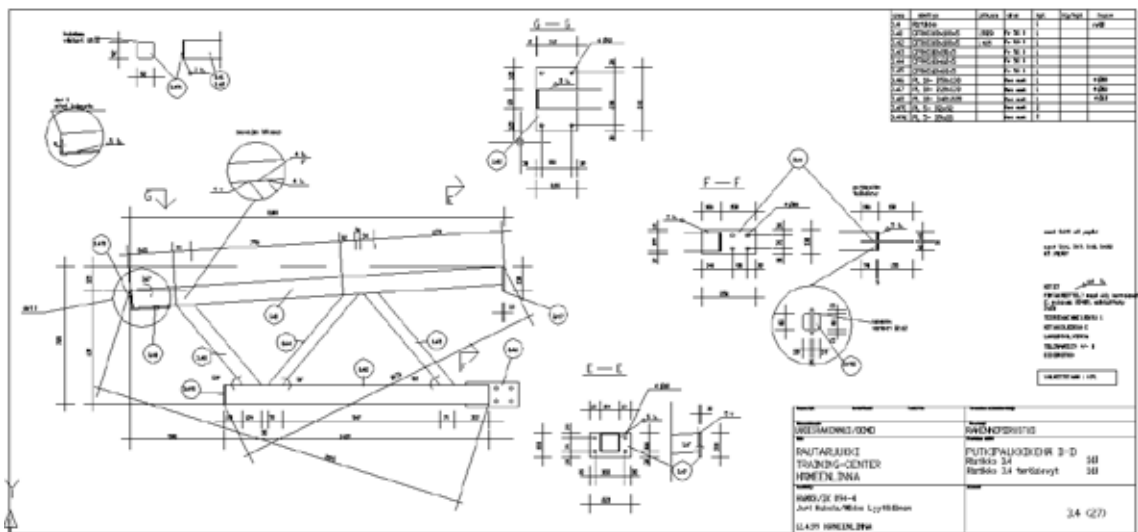

Assembly Drawing



Photo of the Modell Frame

Example Projects

Annex 2

SINGLE- OCCUPANCY

TÄHDENLENTO - PROJEKTI

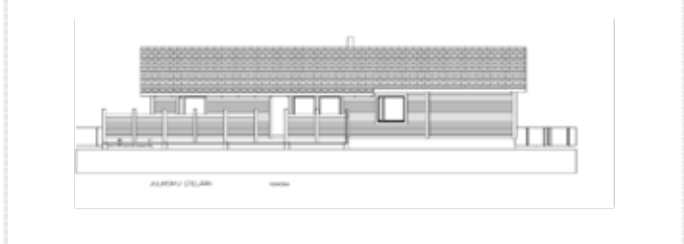
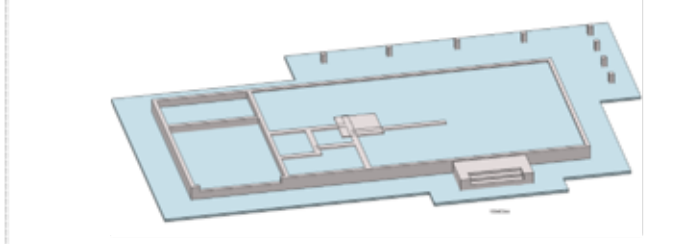
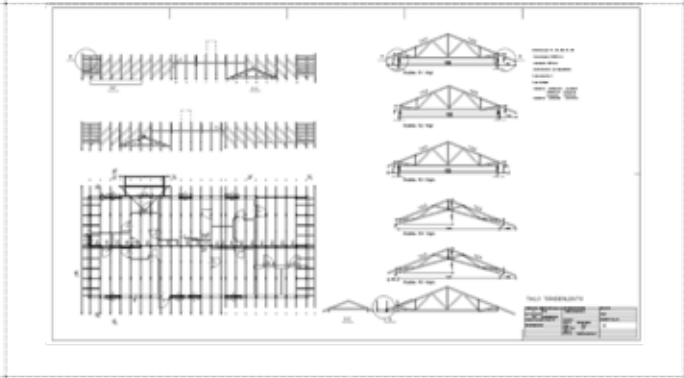
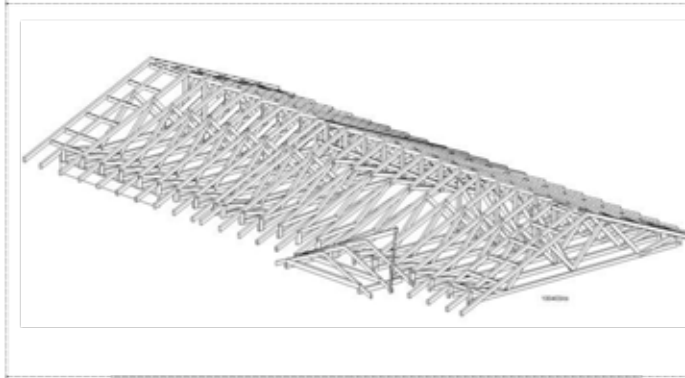
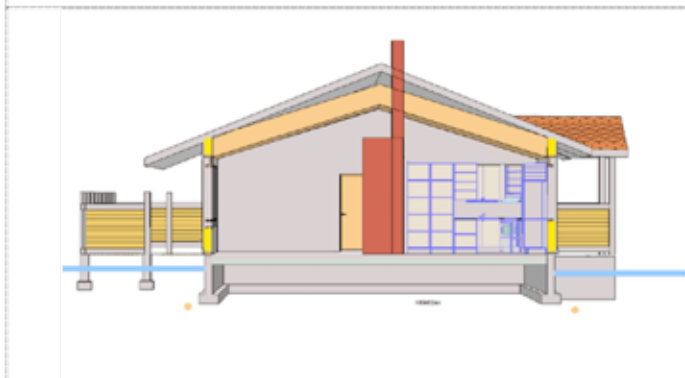
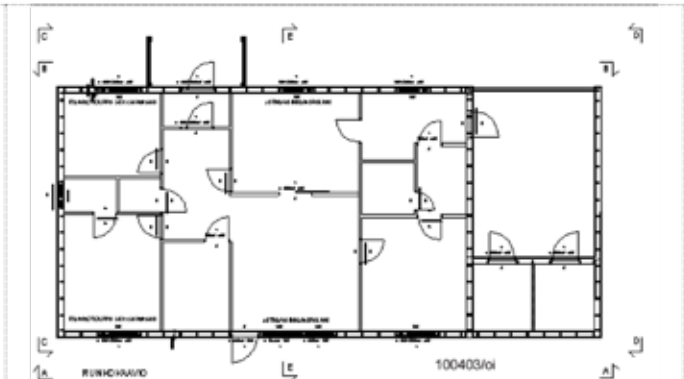
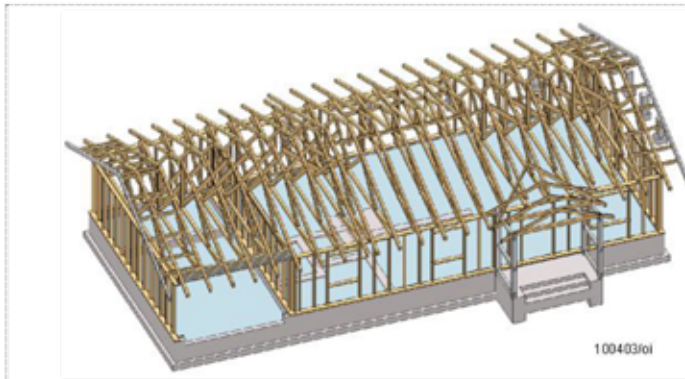

EXAMPLES OF THE STRUCTURAL DESIGNS OF A SINGLE OCCUPANCY

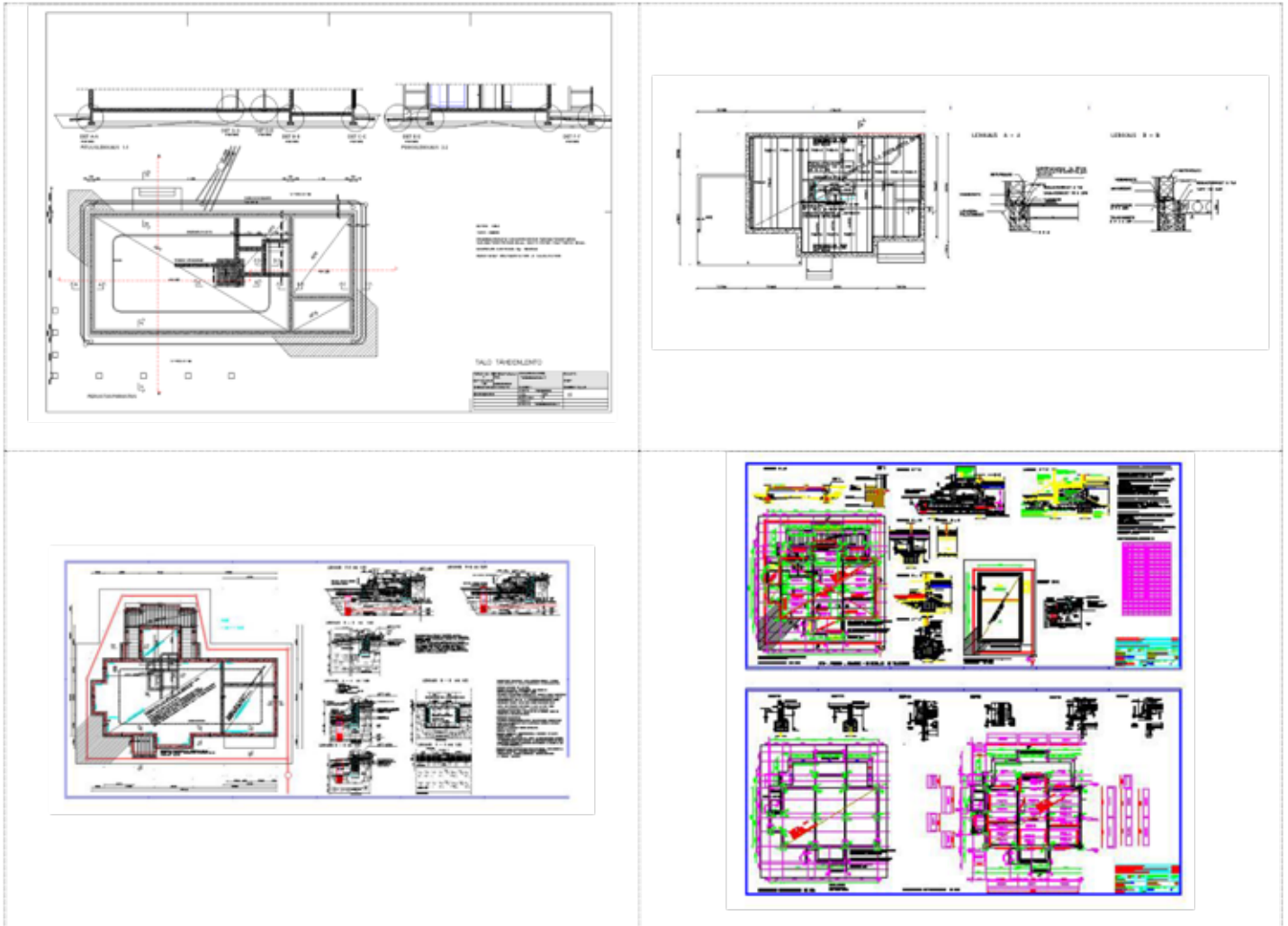

PROIT-BUILDING

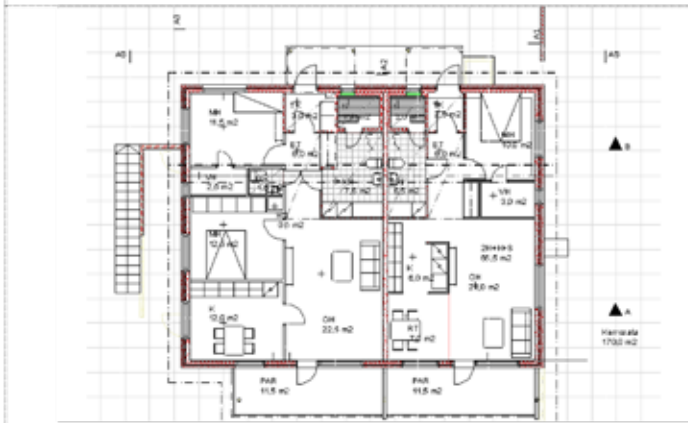
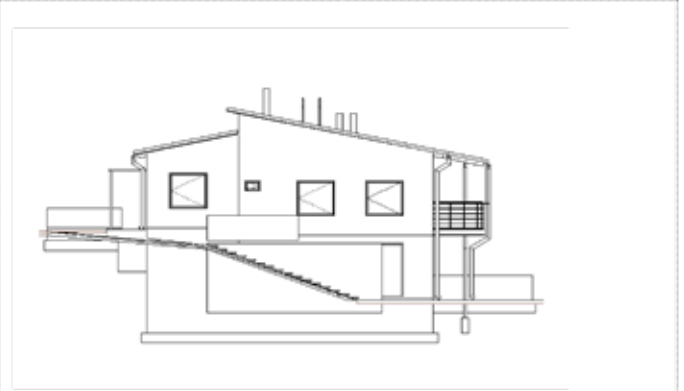

VERTEX BD EXAMPLES

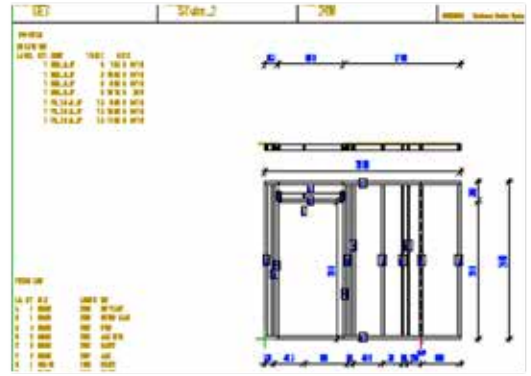
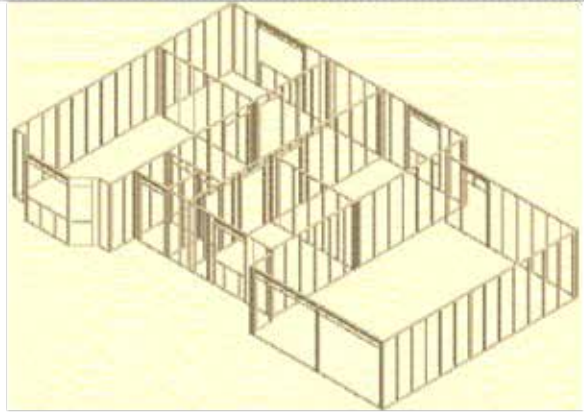
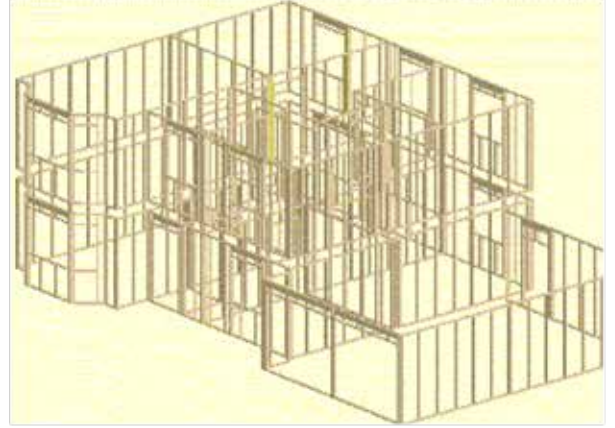

BLOCK OF FLATS

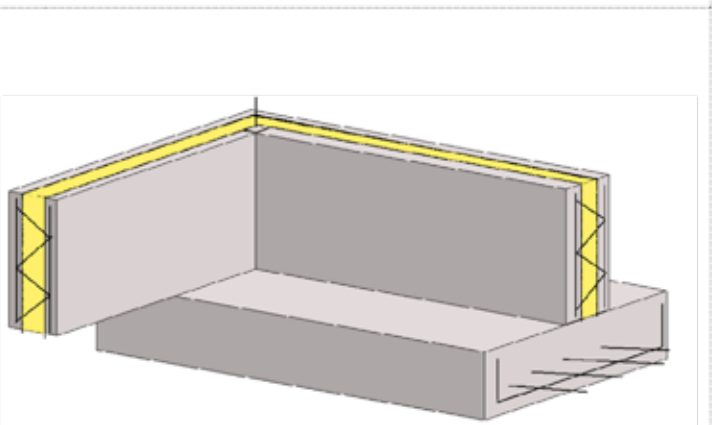
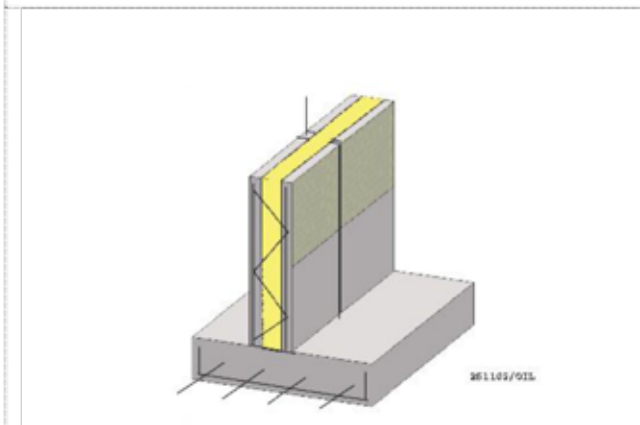
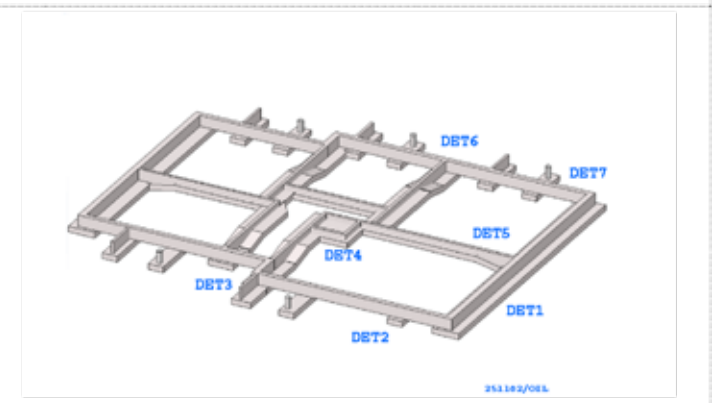

Kuva Detaljkuva 1

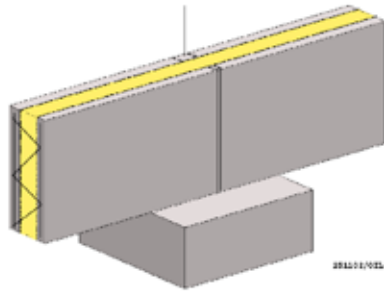

201401/001

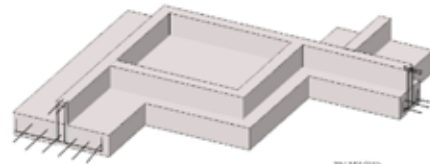

201401/001

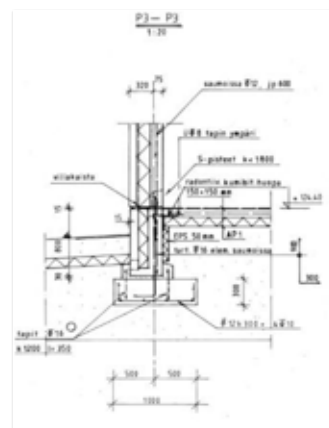
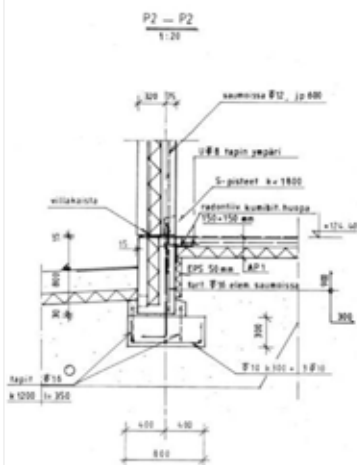
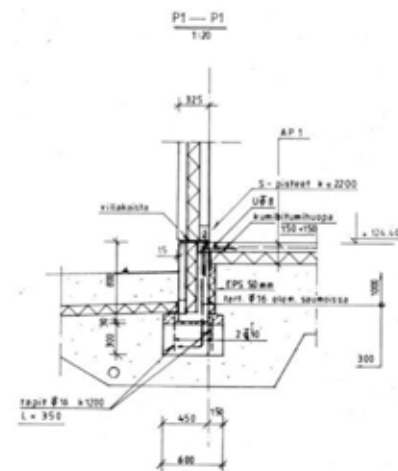
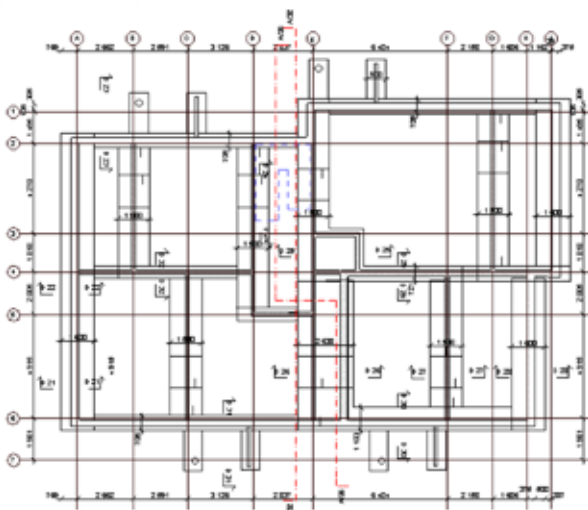

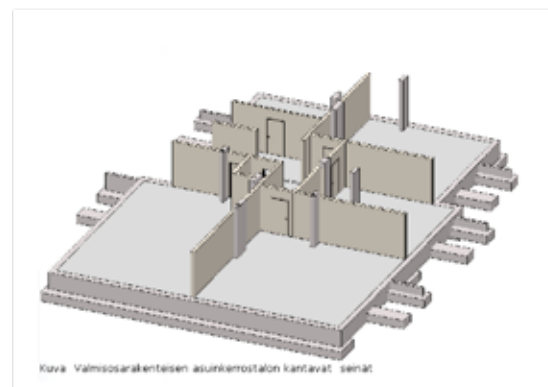
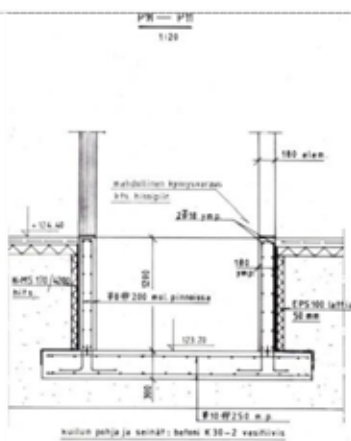
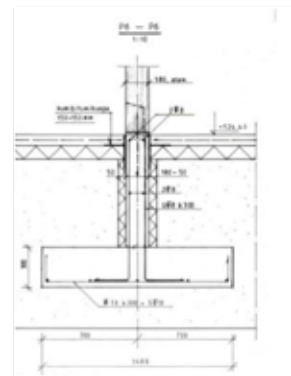
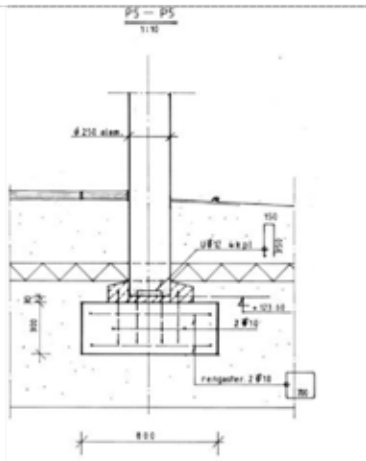
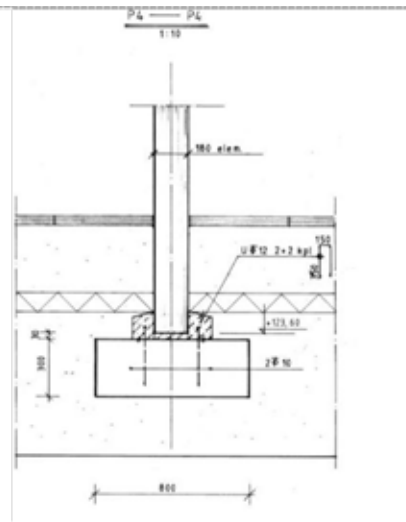
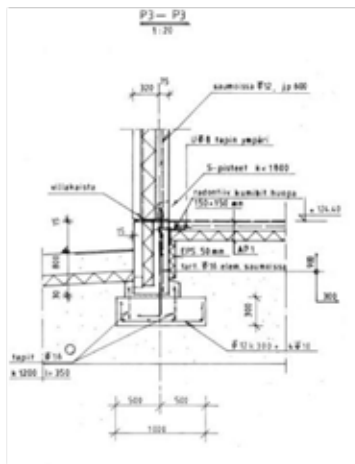

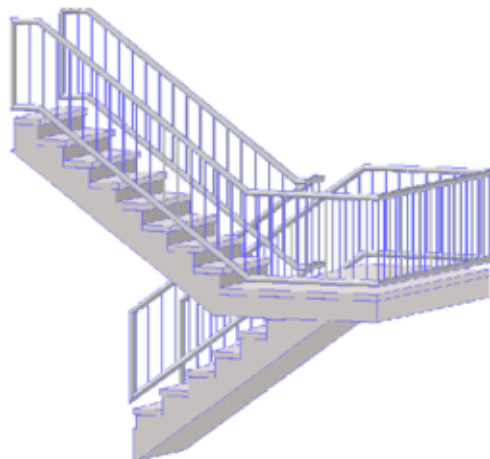
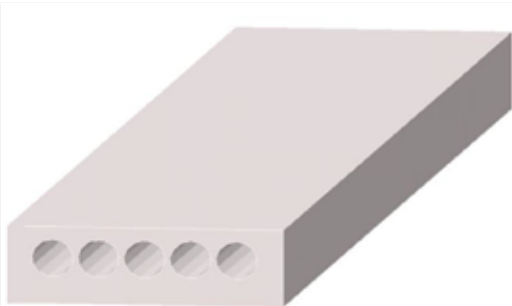
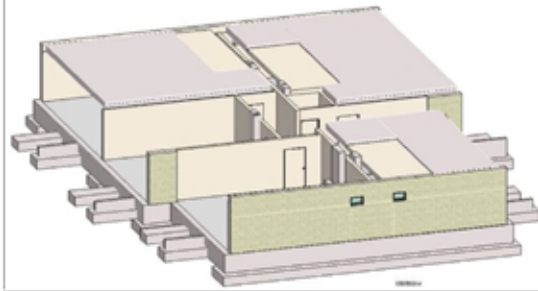
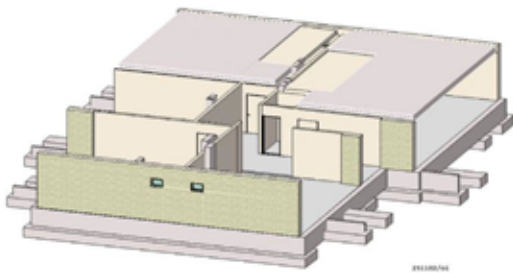

Kuva Asunkerrostalon portaat

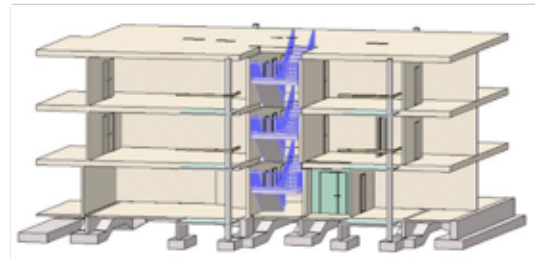
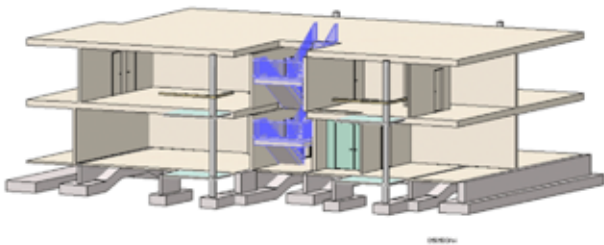
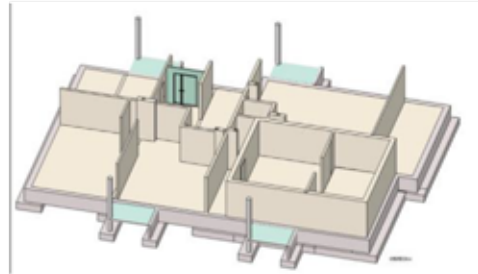
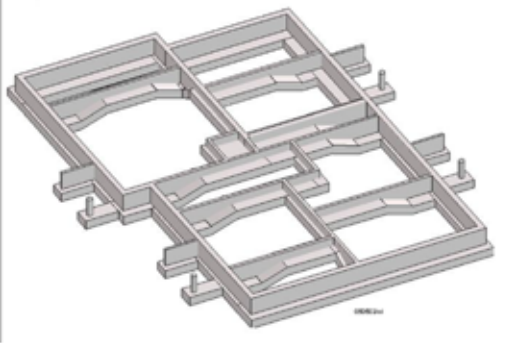
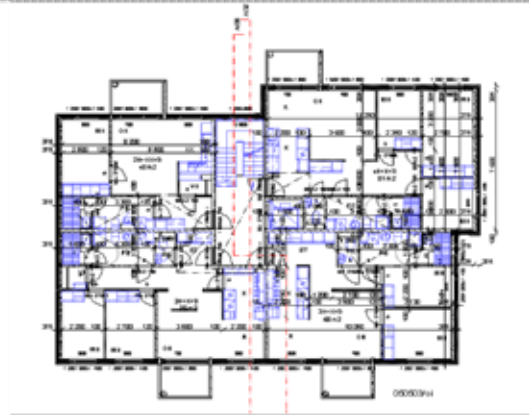

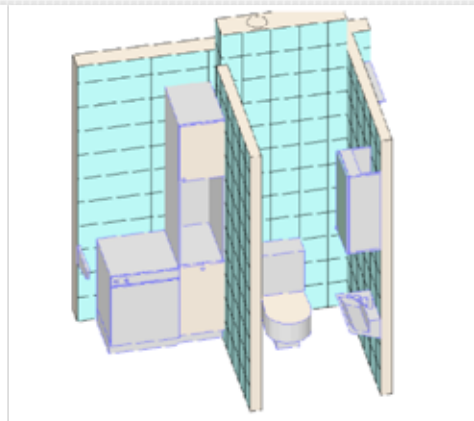
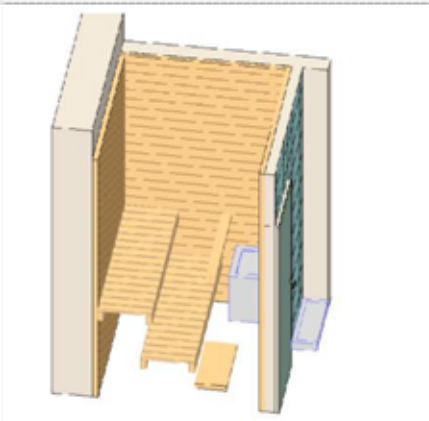
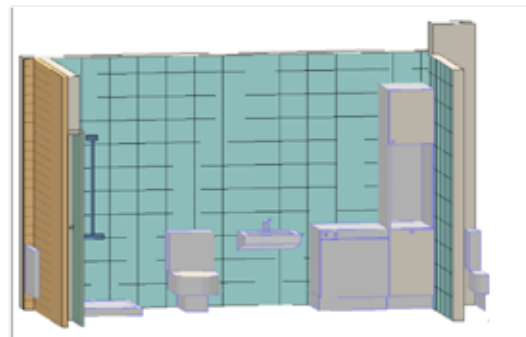
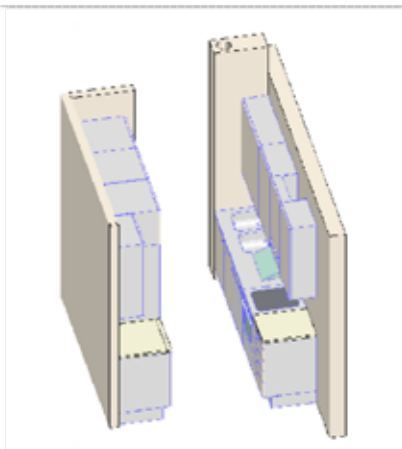
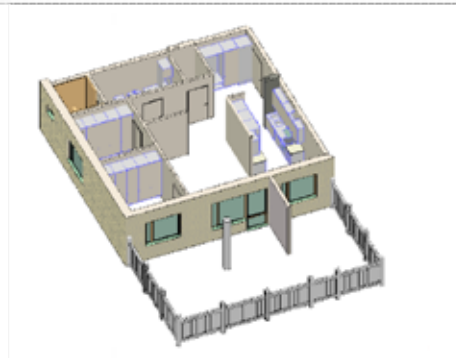
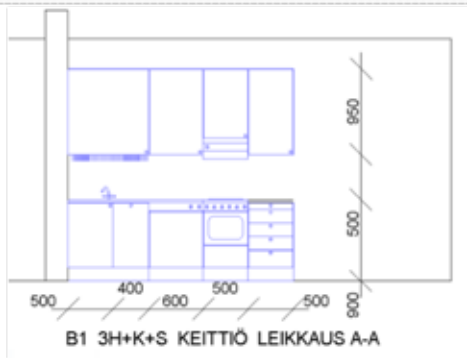



BES- BLOCK OF FLATS

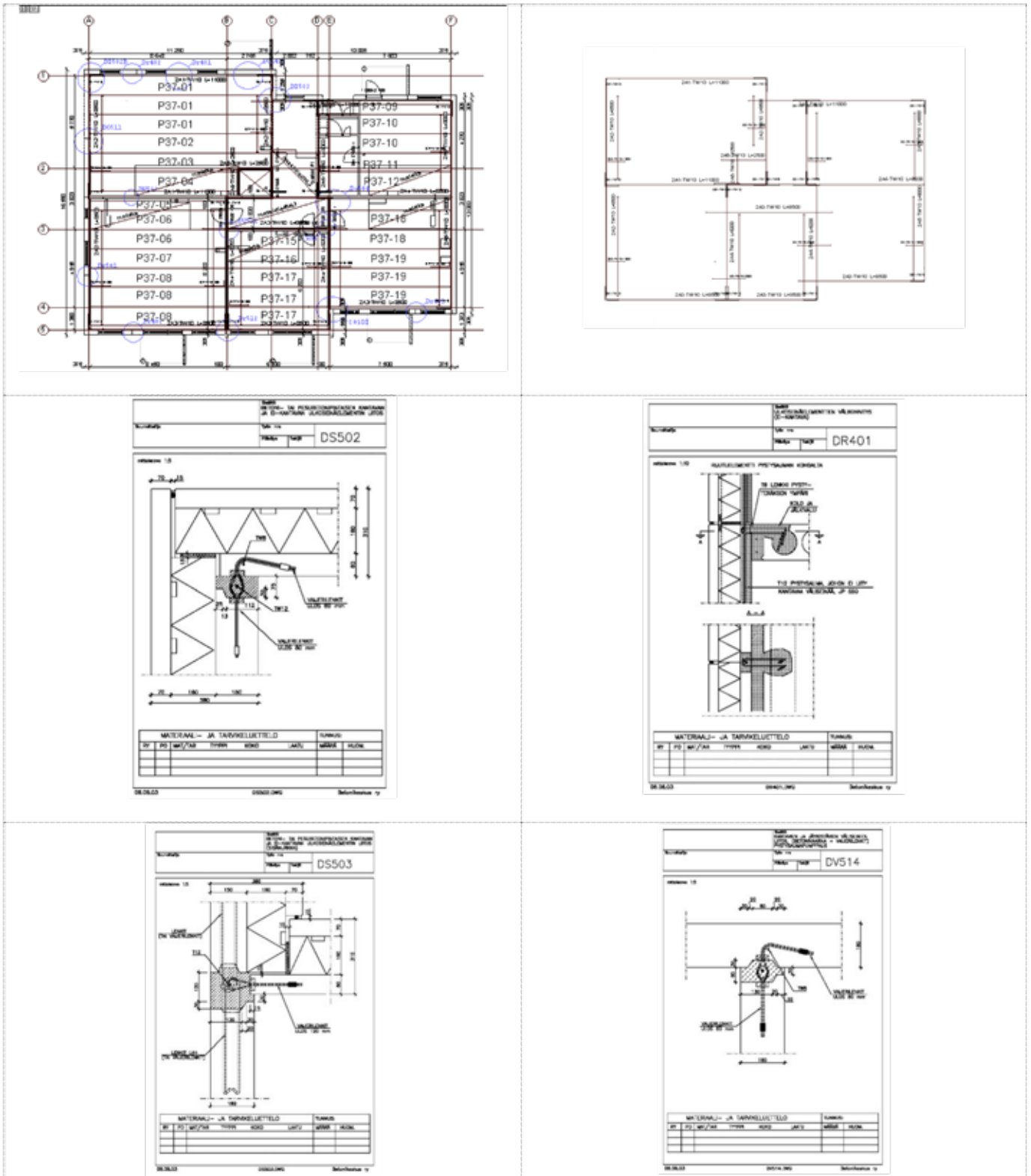

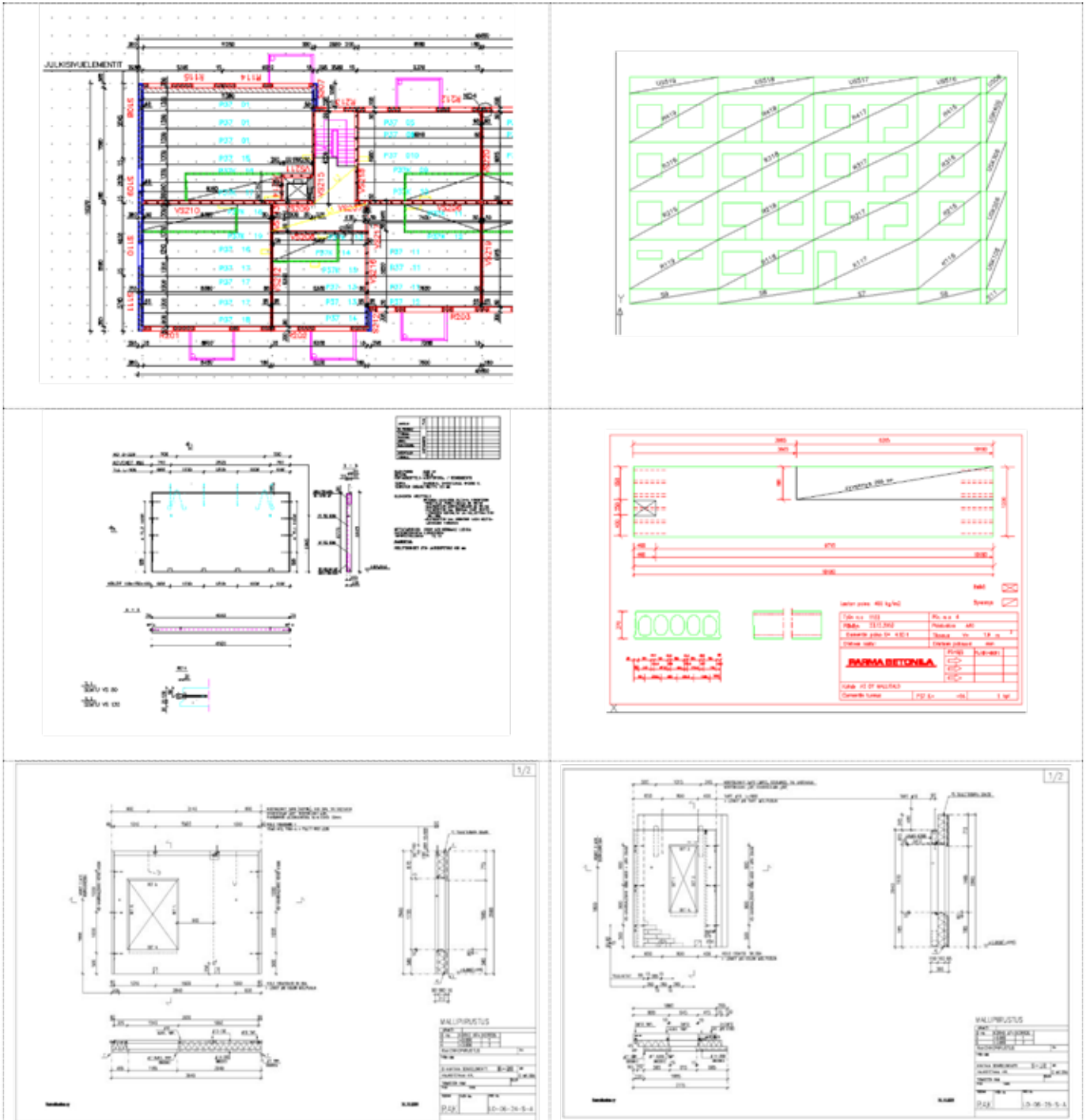

IN SITU BLOCK OF FLATS

ALAPINNAN RAUDOITET

YLÄPINNAN RAUDOITET

RAUDOITELUETTELO					
tyyppi	leveys	s	h	h _{raj}	merkitys
RA1	A500HW	54,30	2250	8	8-200
RA2	A500HW	80,30	2250	8	8-200
RA3	A500HW	89,05	1980	1	8-200
RA4	A500HW	54,30	1900	3	8-200
RA5	A500HW	64,30	2050	8	8-200
RA6	A500HW	64,60	2250	14	8-200
RA7	A500HW	28,00	1900	2	8-200

RAUDOITELUETTELO					
tyyppi	leveys	s	h	h _{raj}	merkitys
RAY1	A500HW	44,30	2250	13	10-200
RAY2	A500HW	60,30	2250	8	10-200
RAY3	A500HW	49,25	1480	8	10-200

ITJ. PAKKAUSLIIKITYS
LAAJIT

LAATIKO/PUOLIKOULU/ALUE/ALUE

DET5

*Korkein lujuusluokka on alustava luokka vähintään luokan C20/25. Lujuusluokkaa ei voi olla korkeampi kuin luokan C20/25. Lujuusluokkaa ei voi olla korkeampi kuin luokan C20/25. Lujuusluokkaa ei voi olla korkeampi kuin luokan C20/25.

ITJ. PAKKAUSLIIKITYS
LAAJIT

LAATIKO/PUOLIKOULU/ALUE/ALUE

DET6

*Korkein lujuusluokka on alustava luokka vähintään luokan C20/25. Lujuusluokkaa ei voi olla korkeampi kuin luokan C20/25. Lujuusluokkaa ei voi olla korkeampi kuin luokan C20/25.

ITJ. PAKKAUSLIIKITYS
LAAJIT

LAATIKO/PUOLIKOULU/ALUE/ALUE

DET9

*Korkein lujuusluokka on alustava luokka vähintään luokan C20/25. Lujuusluokkaa ei voi olla korkeampi kuin luokan C20/25. Lujuusluokkaa ei voi olla korkeampi kuin luokan C20/25.

ITJ. PAKKAUSLIIKITYS
LAAJIT

PUOLIKOULU/ALUE/ALUE

DET10

*Korkein lujuusluokka on alustava luokka vähintään luokan C20/25. Lujuusluokkaa ei voi olla korkeampi kuin luokan C20/25. Lujuusluokkaa ei voi olla korkeampi kuin luokan C20/25.

ITJ. PAKKAUSLIIKITYS
LAAJIT

PUOLIKOULU/ALUE/ALUE

DET11

*Korkein lujuusluokka on alustava luokka vähintään luokan C20/25. Lujuusluokkaa ei voi olla korkeampi kuin luokan C20/25. Lujuusluokkaa ei voi olla korkeampi kuin luokan C20/25.

ITJ. PAKKAUSLIIKITYS
LAAJIT

SEINÄN LIITOS LAATIKOON

DET12

*Korkein lujuusluokka on alustava luokka vähintään luokan C20/25. Lujuusluokkaa ei voi olla korkeampi kuin luokan C20/25. Lujuusluokkaa ei voi olla korkeampi kuin luokan C20/25.

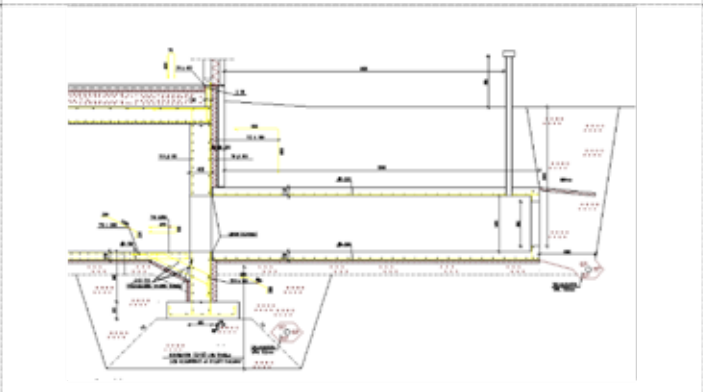
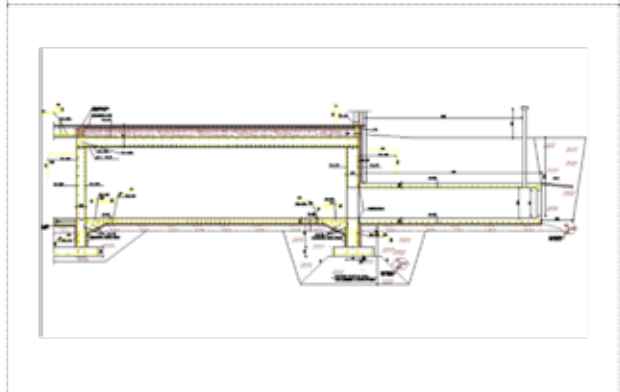
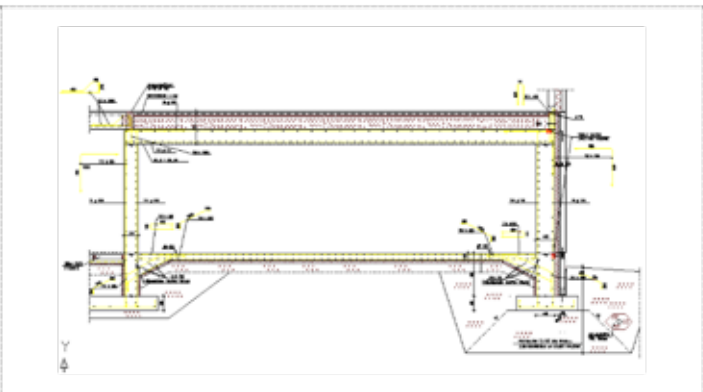
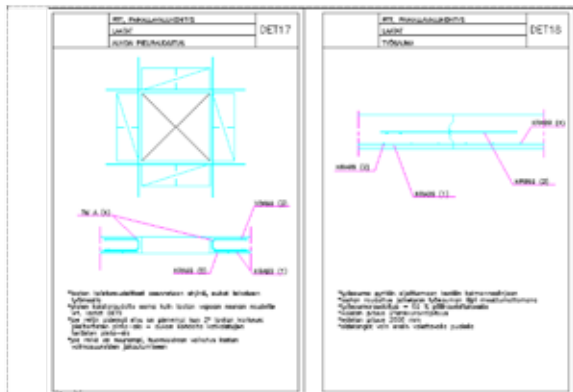

CONCRETE UNIT FRAME HALL

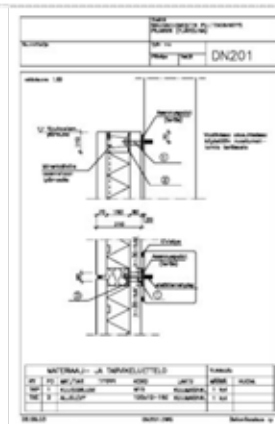
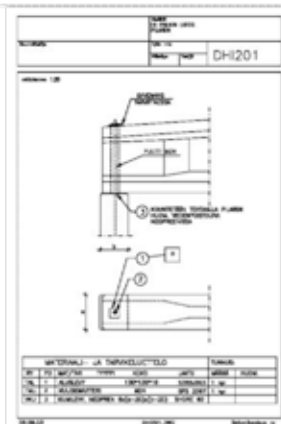
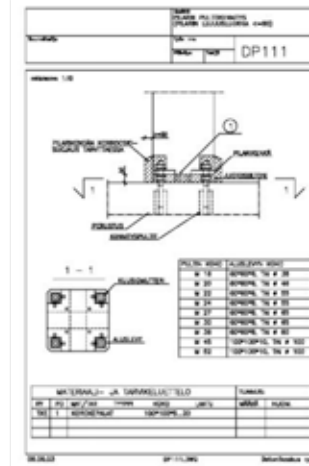
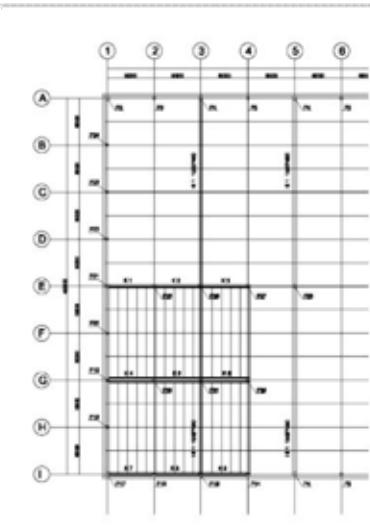
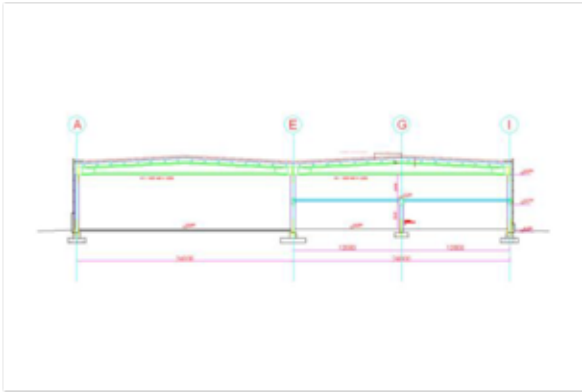

REVIT – CONCRETE UNIT HALL

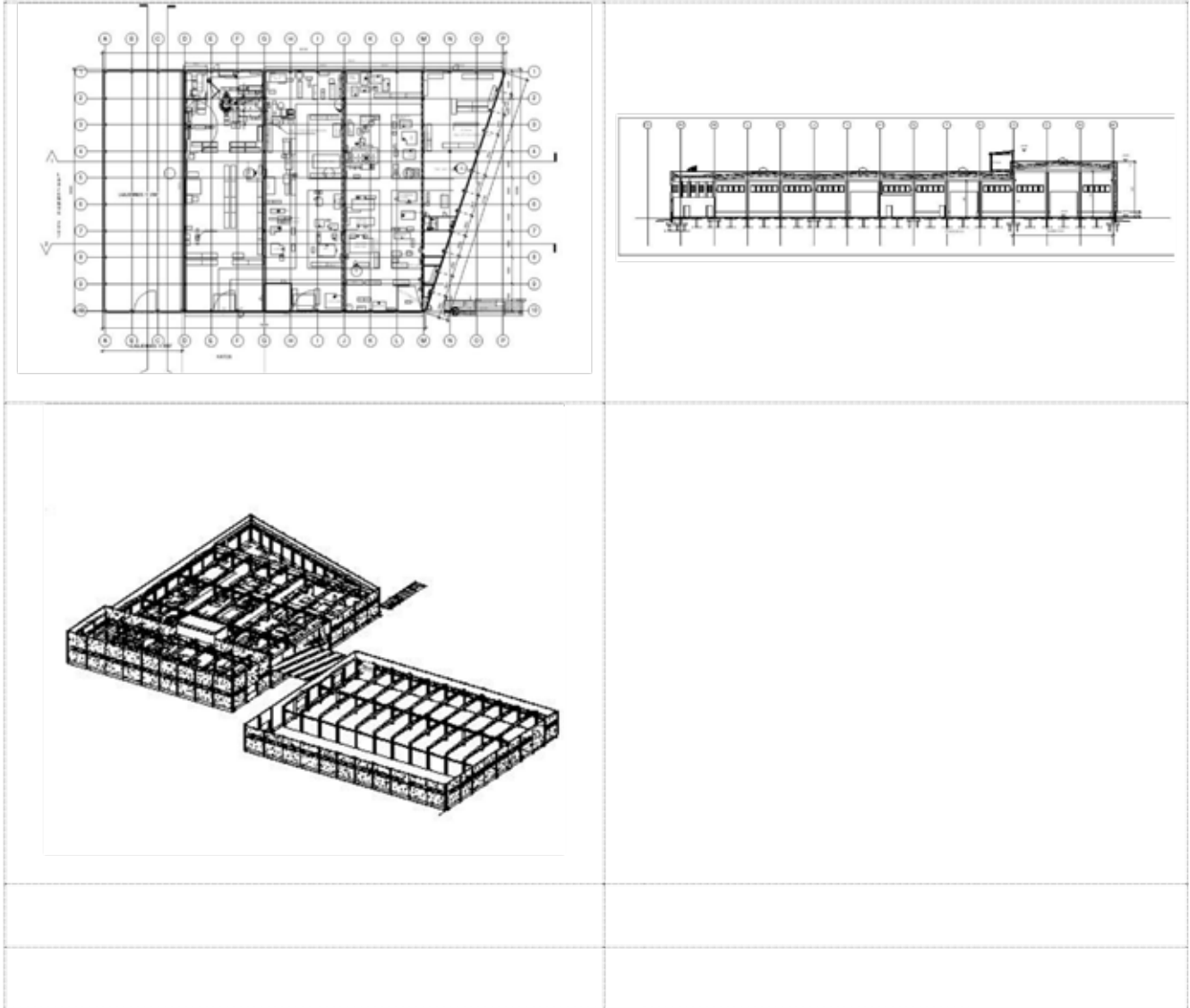

TIMBER FRAME HALL

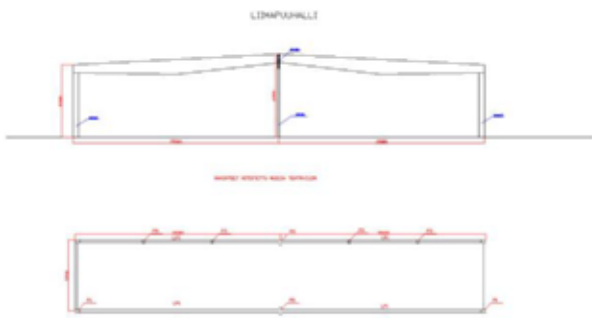
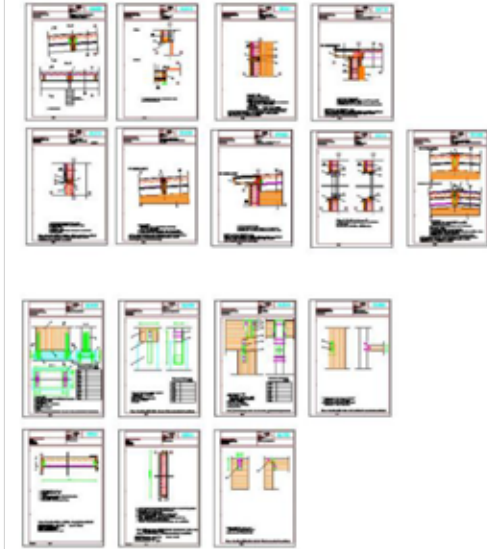

Annex 3

Master format example

F CONSTRUCTION ENGINEERING

F1 FOUNDATIONS

F11 Pad Foundation

AN01 Pile foundation

- reinforced C30/37
- stiff fastening to the pole

AN03 Strip foundation

- reinforced concrete strip, C30 /37
- rock anchors TW20 s 1000mm L = 1000+ 1000mm fastening to the rock

F11 quality requirements

- RunkoRYL 2000 23.42 is followed
- quality of the surfaces by 40 class 2
- tolerances insitu by 39, section 2 class 1
- measures and reinforcement according to the structural designs
- freezing must be prevented.

F13 base floors

AP01 Hollow core slab 265 mm, cell polystyrene 50 + 125 among others, ventilated base floor

- hollow-core slab 265 mm
- polystyreenboard NS 50 mm, width 1000 mm
- ventilated space 600 mm

AP06 Reinforced concrete slab h= 100 mm, light gravel insulation 300 mm

- reinforced concrete slab 100 mm, C30/37, central mesh reinforcement 8-150 B 500 K
- the protection paper
- light gravel 300 mm
- drainage

F13 quality requirements

- RunkoRYL 2000 23.45 is followed 23.46, 25.53, 61.411, 61.413 And 61.42
- quality of the surfaces by 40 class 2
- tolerances insitu : by 39, section 5, normal class elements:

F2 FRAME

F23 Stairs

PO01 Element stairs, b = 1260 among others, h = 3000

- prefabricated 2-lane stairelement, width 1260 mm, step 270 mm, rise 176.47 mm, layer height 3000 mm
- step surfaces, front edges and front chests ground mosaic concrete, shade and graininess according to architect, finish once in factory and once on site
- the space of stairs and the wall is seamed
- RunkoRYL 2000 23.47 is followed 25.54 and RT 31-10066
- quality of the lower surface by 40 class 2
- tolerances: Valmisosarakentaminen, part E, soon 4.9, normal class

F24 Bearing partition walls

VS01 Reinforced concrete unit 180 mm

Stair room and lift shaft

- reinforced concrete 180 mm, C30/37
- thickness of the wall 200 mm, if the flat is closer than 2 metres of the stair room or the lift shaft

RunkoRYL 2000 25.51 is followed

- quality of the surfaces by 40 class 2
- tolerances: Prefabricated Unit Construction, part E, section 4.10 normal class
- $R_w=60\text{dB}$
- fire resistance REI180.

F3 FACADE

F31 Facades

US01 Bearing Concrete sandwich-element 160

- inner panel reinforced concrete 160 mm, C35
- insulation, mineral fibre wool 240 mm, class 02.005
- vent channels
- outer panel reinforced concrete 70 mm, C35 weatherproof, rustproof reinforce
- granite plates 300 x 600 x 30 mm, colour architect, polished burnt the part and the part along
- seams elastic seam mass

US02 Betonisandwich-elementti 80 + 70 mm, mineral fibre 240 mm

- as US01
- inner panel reinforced concrete 80 mm, C35/45

F31 quality requirements

Reinforced concrete

- RunkoRYL 2000 25.52 is followed
- quality of an outer surface and inner surface by 40 class 2
- tolerances of elements: Concrete Unit Construction, part E section 4.10 normal class

Insulation

- RunkoRYL 2000 61.411 is followed
- Insulation is tightly connected to a warmer surface

Seaming

- class 1 is followed, RT 82-10527

Ventilation

- the ventilation pipes are extended from the surface, about 20 mm out and inclination downwards

Granit tile

- RunkoRYL 2000 431.42 is followed and RT 30-10314
- tolerances of plates RunkoRYL 2000 table 431:T1
- overlaps according to the architect's instruction
- vertical joint 6 mm and horizontal joint 15 mm, vertical joints to level of the surface of the plate and horizontal joints

Plate surface 5 mm deeper

Brick tile

- RunkoRYL 2000 25.14 is followed
- allowed tolerances of brick plates by 40 table T class 2
- integrity of the brick plates by 40 section 7 table 3
- Run overlap of 1/3 stones
- vertical joint 15 mm and horizontal joint 15 mm,

vertical joints to level of the surface of the plate and horizontal joints

Plate surface 2 mm deeper

Brickwork

- RunkoRYL 2000 411.431 is followed
- ready surface that has been masoned RunkoRYL 2000

table 411:T4 class 2

- tolerances of the masoned wall RunkoRYL 2000

411:T1, 411:T2 and 411:T3 OF tables class

- integrity of the brick stones by 40
- 1/2 overlap of the stone, seaming to full seam.

F32 WINDOWS

IP01 3 glass tree aluminium MSE window, frame depth 175 mm

- frames and setting industry paint wood, frame depth 175 mm,
- EPDM gasket , grade II glasses or Float glass, thickness according to the screen size
- painting of aluminium parts at least 430.3
- surface bushings standard quality
- factory-painted mountain list 12 x 45 mm, inside window
- sealing from inside with polyuretan
- seaming from outside with 2 component seaming
- water plates powderpainted aluminium 1,5 mm

RYL WORK SECTION EXAMPLE

23 Concreting

Contents

- reception of the concrete
- transfers
- casting
- compaction
- coarse levelling
- assisting work.

Instruction

The definitions are presented in a term directory at the end of the book.

- mould work which is dealt with in chapter 21
- reinforcement which is dealt with in chapter 22
- concrete surfacing which is dealt with in chapter 24
- concrete unit work which is dealt with in chapter 25 r
- correction of concrete surfaces which is dealt with SisäRYL 2000 in number 26
- crushing and patching which are dealt with in chapter 27.

Reference

SisäRYL 2000 general quality requirements of building work 2000. Inner work of the house building.

23.1 Concrete

Demands

The strength class and other properties of the concrete are according to the designs. The properties of the concrete connected to the environment class are according to the publication by

32. Concrete equals the Building Regulation demands of Finland and the demands set in the publication by 15.

The used cement is according to standards in Finland. Mixture materials and the water are according to the regulations and publication by 15 .

Instruction

In the part of RakMK B4 has been presented demands for the concrete quality control of part materials and work performance and from stating of the competency up to strength class C60/70.

In the publication by 15 the additional instructions have been presented up to the class C100/120.

If concrete fills the publication by 32 demands, it will reach an about double service life with respect to B4 demands of the RakMK.

The concrete it is recommended to fulfill the demands of the publication by 32 .

The choice of the concrete examples have been given in regulations of the Concrete Unit Construction. For example in the part J are instructions for the balconies and in D choice of the concrete of facades and structures.

References

- B4 concrete structures. Instructions 1987. Finland's building regulations
- by 15 concrete norms. RakMK B4 and high strength additional instructions of concretes. Finland's Betoniyhdistys r.y.
- by 32 instruction of preserve of concrete structures and service life dimensioning. Finland's Betoniyhdistys r.y.
- by 43 rock materials of the concrete. Finland's Betoniyhdistys r.y.
- Regulations of the Valmisosarakentaminen part D Betonijulkisivus, part J Betoniementtiparvekes. RTT concrete industry.

Instruction

Composition of cement, quality requirements and competency criteria it has also been presented in the European standard SFS EN 1992-1-1 and 2. The properties of the concrete, concreting and the stating of the competency also presented in the EN standards.

References

SFS ENV 197-1 Cement. Composition, quality requirements and competency criteria.

SFS ENV 206 Concrete. Properties, making concreting and stating of the competency.

23.4 In Situ concreting

Demands

Before the concreting a written concreting plan is made. During the concreting a concreting report is made. The concreting is made according to the concreting plan so that concrete fills the moulds carefully and surrounds the reinforcement. The concrete cover thickness of the

reinforcement must be according to the designs. When concreting floors, the instructions that have been given in the publication by 31 are followed .

Instruction

The matters presented in the concreting plan and in the reports are presented in the form by 401. Concreting methods have been presented in the publications RIL 149, by 201 and by 32. The concreting methods of floors have been processed in publications by 31 and BLY 5.

Instruction

The protection thickness of the concrete covering of the reinforcement has been given in the publication by 32 in table 3.3. In section 3.3.4 it is presented how much from the strength can differ from the strength if the thickness of the concrete covering is increased.

References

BLY 5 production methods of concrete floors. Finland Concrete association r.y Finland's Betonilattiayhdistys r.y.

by 31/BLY 4 concrete floors. Classification, päällystettävyyss planning instructions and building instructions. Finland

Concrete association r.y Finland's Betonilattiayhdistys r.y.

- by 32 säilyvyysohje of concrete structures and service life dimensioning. Finland's Betoniyhdistys r.y.
- by 201 textbook of the concrete technology. Finland's Betoniyhdistys r.y.
- by 401 concreting record. Form. Finland's Betoniyhdistys r.y and Rakennustietosäätiö
- RIL 149-1983 Betonityöohjeet. Finland's Rakennusinsinööris Union.

Instruction

The concreting methods are described in Ratu method cards 106 M2 and 23-0013. In the cards it is described from methods work wholeness, team, materials machines and equipment, method of work, industrial safety and quality assurance.

References

- Ratu 106-M2 Concrete slab on ground
- Ratu 23-0013 Concreting work. Methods.

**TOTEUTUSSUUNNITELMA
COURSE PROGRAMME**

Annex

3

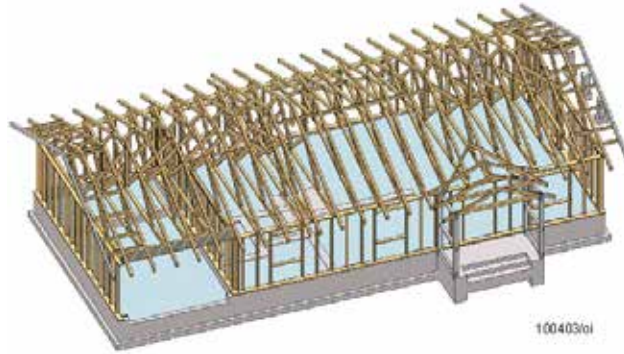
**OPINTOJAKSO
COURSE NAME:**

09420122 Building Construction 1

**GROUP
RYHMÄ:**

BECONNU

CREDITS:

4 cr

TEACHER:**TIME:**

2008

OBJECTIVE:

This course provides an understanding of the practice of the Building Construction. It builds upon the fundamental skills developed in Mechanics and Structural Engineering and presents the principles of construction methods and construction technology. The course provides a perspective for dealing with the issues of Building Process, Foundations, Building Materials, Framing, Structures, Thermal, Acoustical and Moisture Protection and Fire Engineering.

It also introduces students to the design of a single occupancy, multi-storey residential houses, industry- and office houses.

RECOMMENDED BACKGROUND:

Mechanics

STUDY METHODS:

Hands-on design experience and skills will be gained and learned through problem sets and a comprehensive design project. An understanding of real world open-ended design issues will be developed. The student is a member of a learning group and attends the contact sessions, seminars and excursions. The course equals 100 student-hours, 24 lesson-hours + 24 practice-hours + 52 independent work hours.

COMPLETION REQUIREMENTS:

Final grades will be calculated as follows:

Activity 20%

Assignments 50%

Final Exam 30%

REFERENCES:

STEP 1-2 Timber Engineering Programme

ACCESS

ESDEP

Ellison D.C.,Huntington W.C.,Mickadeit R.E., Building Construction

EC5 Esimerkkilaskelmat

Kähkönen: Kantavat Puurakenteet

Betonitekniikan oppikirja 201

Betonirakenteiden perusteet 203

Betonirakenteiden oppikirja 210

Teräsrakenne-romppu

Höyhtyä, Vanttinen, Muuratut Rakenteet

www.woodfocus.fi

www.betoni.com

www.kivitalo.fi

www.terasrakenneyhdistys.fi

Ilveskoski Olli, Building Construction Study Books 1 – 2

ASSIGNMENTS:

Problem sets and a comprehensive design project such as a residential small house. The assignments are made in 3 student's workgroups and presented in the Final Seminar with A1 -tables consisting the portfolio and final designs.