

Saimaa University of Applied Sciences
Technology, Lappeenranta
Double Degree Programme in Civil and Construction Engineering

Georgii Diagilev

VERIFICATION OF THE BEARING CAPACITY OF THE NEW TERMINAL'S ROOF

Thesis 2015

Abstract

Georgii Diagilev

Verification of the Bearing Capacity of the New Terminal's Roof, 74 pages, 4 appendices

Saimaa University of Applied Sciences

The Faculty of Technology, Lappeenranta

Double Degree Programme in Civil Engineering and Construction

Thesis 2015

Instructors: Lecturer Petri Himmi, Saimaa University of Applied Sciences

Managing Director Jochen Herter, Northern Capital Gateway LLC

This thesis was made for Northern Capital Gateway LLC, which is an operator and the developer of Pulkovo airport in Saint Petersburg, Russian Federation. The project of the new terminal's roof superstructure was made twice in Great Britain and Russia. The purpose of the research was to compare design methods in these countries. In addition, the task was to analyse the impact of Euro-code system and Russian National Codes on calculation and the final result.

The information was gathered at the airport from the drawings and by interviewing engineers, structural designers, and builders. Jochen Herter, passenger terminal project manager, commissioned the work.

The final result of this thesis shows which calculation gets bigger bearing capacity and why. Based on the findings it is easy to check the capacity of the structure and verify the roof's reliability. Further study is required just to make independent calculation and prove economical estimation of the materials usage.

Keywords: steel structure, roof, bearing capacity, airport, terminal, calculations

Table of contents

1	Introduction	4
2	Historical development and characteristics of structural steel in Russia.....	5
2.1	Structural steel history	5
2.2	Range and scope of the metal structures	10
3	National Codes in the United Kingdom (Europe) and Russia	14
3.1	The United Kingdom and Eurocodes	14
3.1.1	Key elements of the Eurocode design	14
3.1.2	Strategies for accidental design situations	15
3.1.3	Risk assessment.....	16
3.1.4	Risk assessment methodology	16
3.1.5	Structural design risk mitigation measures	17
3.2	Russian Federation codes and standards	17
3.2.1	Saint Petersburg Territorial Building Standard	18
3.2.2	Moscow State Construction Norm	19
4	Development, Calculation and Applied Software	21
4.1	English combination of loads	25
4.2	Truss design development.....	27
4.2.1	Option 1 - Concrete roof box girder	29
4.2.2	Option 2 – Steel box girder	30
4.2.3	Option 3 – Steel plate girder	30
4.2.4	Option 4 – Planar truss	31
4.2.5	Option 5 – Trichord truss	33
4.2.6	Trichord truss geometry evolution	34
4.3	‘Star Truss’ Design Philosophy	37
4.3.1	‘Star Truss’ – Principal Structural Elements	37
4.4	Hazard philosophy	53
4.5	Analyses of the UK frame system.....	56
4.5.1	Non-linear analysis	56
4.5.2	Buckling analysis	57
4.5.3	Full compliance with Eurocodes	58
4.6	Russian combinations of loads	59
5	Roof Structure	63
5.1	The Final Roof Structure Designed by London Engineers.....	63
5.2	The Final Roof Structure Designed by Saint Petersburg Engineers...	68
6	Summary.....	70
	FIGURES.....	72
	CHARTS.....	73
	TABLES.....	73
	REFERENCES.....	74
	APPENDICES	74

1 Introduction

This thesis was done for the operator of Pulkovo airport (Saint Petersburg, IATA code: LED), called Northern Capital Gateway LLC (NCG). The airport has been managed by NCG since April 29, 2010.

Together, with efficiency in the airport's operational management, an important objective for Northern Capital Gateway Consortium involves reconstruction of airport facilities and improvements to ensure an IATA "C" standard level of passenger service. During 2011–2014 the following facilities were built and put into operation: a new international passenger terminal with an area of 145 000 m², new passenger and cargo aprons, an on-site hotel and business centre, a car parking complex, and other airport surrounding infrastructure facilities. (Pulkovo Airport website)

As well as the new terminal, the modernisation of existing, dated accommodation transforms the airport in to a facility suitable for modern day travel. The overall design respects the airport's historic context and contributes to the operator's long-term plans to achieve a capacity of 22 million passengers per year.



Figure 1.1 Internal architecture of the roofing. (Grimshaw Architects website)

The concept of the terminal roofing takes its inspiration from the layout of St. Petersburg, namely bridges, rivers and islands. Laid out in interconnecting zones, the grandeur of the large open spaces provides a fitting environment for the travelling passenger. (Pascall+Watson website)

The London architectural bureau Grimshaw & Partners Ltd developed the design of the terminal building. The original roof of complex design is a metaphor, becoming gold by sunlight — causes in memories gilded domes of the city churches and its bright night lights. (Pulkovo Airport website)

The structural design of the roof was included in the project. English engineers made huge calculation work to implement the best solution. They used both European Codes and Russian National Codes to adopt documents for the authority's examination and to get a cost-effective option. Two years later, in 2012, another calculation was made by Russian engineers who got a different structural scheme.

This thesis will narrate the development of the project in both countries and try to research why results were not agreed with each other and what factors had action upon this.

2 Historical development and characteristics of structural steel in Russia

The definition of metal structures includes structural form, technology of production and methods of assembling. The level of the development of the metal structures usually depends on people needs, technical possibilities, metallurgy and engineering science. In fact the history of metal structures can be divided into five periods. (Metal structures, 2010)

2.1 Structural steel history

The first period (from XII century till XVII century) can be characterized with using metal in unique at that time structures (palaces, churches etc.) as strings for rock masonry. Strings were moulded from iron and fixed by drift bolts. One of the first of such constructions is the Uspenskiy Cathedral in Vladimir (1158). Pokrovskiy Cathedral - St. Basil's Cathedral (1560) in Moscow is the first known structure consisting of rods, working with the tensile, bending and compression, to support the stone ceiling above the tholobate. It is striking that even at that

time the designer knew that the structure working for a bending and struts running on compression so it is better to make a square cross-section.

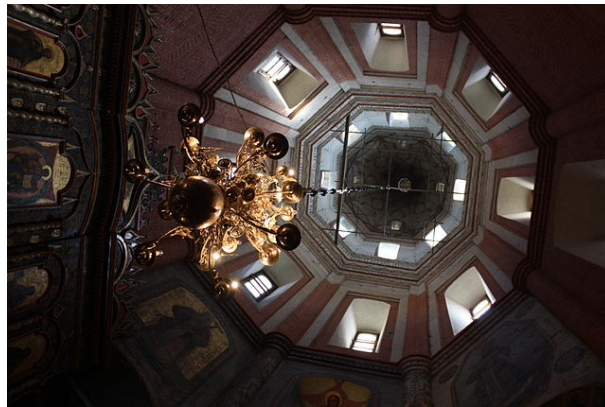

Figure 2.1 Structures inside St. Basil's Cathedral in Moscow (Wikipedia website)

The second period (from the beginning of the XVII century until the end of the XVIII century) associated with the use of inclined metal trusses and space dome structures ("baskets") of the church leaders. The rods were made of wrought iron designs and bars are connected to the locks and strings by hearth welding. Constructions of this type have survived upon our days. The examples are covering a span of 18 m over the refectory of the Troizko-Sergievskii Monastery in Zagorsk (1696 - 1698), the overlap of the Bolshoi Kremlin Palace in Moscow (1640), the framework of the dome Ivan the Great Bell (1603), the framework of the dome of the Kazan Cathedral in Saint Petersburg span of 15 m (1805) and others.

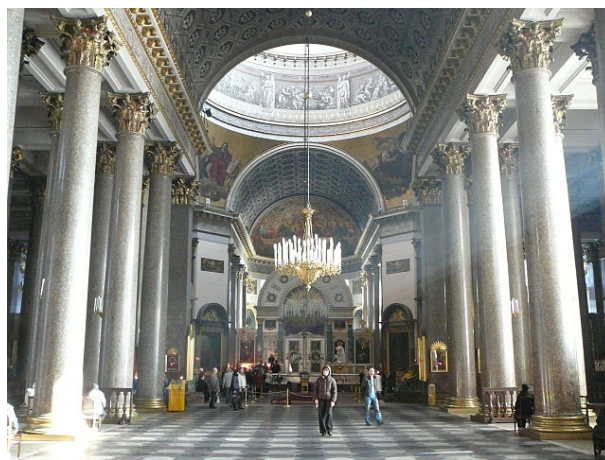

Figure 2.2 Interior of the Kazan Cathedral in Saint Petersburg. (Wikipedia website)

The third period (from the XVIII century until the middle of the XIX century) associated with the development of the process of casting iron rods. The period is famous for construction of cast iron bridges and the floor structure of civil and industrial buildings. Connection elements are made of cast iron with the locks or bolts. The first cast-iron construction in Russia is considered to be the overlap porch of Nev'ianskoy Tower in the Urals (1725). In 1784 in Saint Petersburg the first cast iron bridge was built. Cast iron construction in Russia reached high-level in the middle of XIX century.



Figure 2.3 The first cast iron bridge in Saint Petersburg. (Wikipedia website)

A unique cast-iron construction of the 40's of the XIX century as is convention to think is the dome of St. Isaac's Cathedral, collected from the individual stocks in the form of a solid shell. The structure of the dome is composed of an upper conical portion supporting a tile drum crowning cathedral, and lower, flatter part. The outer shell of the dome with a light iron frame rests on a cast-iron construction.



Figure 2.4 Structural section of the St. Isaac's Cathedral. (Wikipedia website)

A cast-iron arch span 30 m is applied in the overlap Aleksandrinsky Theatre in Saint Petersburg (1827 - 1832). In the 50's of the XIX century in Saint Petersburg Nikolaevskii bridge with eight arched spans from 33 to 47 m was built, which is the largest cast-iron bridge in the world. In the same period inclined rafters are gradually transformed into mixed cast-iron triangular trusses. In the beginning it was not farm braces, they have appeared at the end of the period. Compressed rods farms were often made of cast iron and stretched - of iron. The nodes of the elements were connected through eyelets screwed. Absence of the rolling and profile metal during this period limited the constructive form of iron rods rectangular or circular cross section. However, the benefits of the shaped profile have been understood and rods of angle or channel section were produced cabriole or forging hot bands.

The fourth period (from the 30's of the XIX century up to the 20's of XX century) is associated with rapid technological progress in all areas of technology of that time and, in particular, in metallurgy and metalworking.

At the beginning of the XIX century bloomer iron-making process has been replaced by more sophisticated - puddling, and at the end of the 80's - the smelting of iron from iron in the converter and open-hearth shops. Along with the Ural base in the southern Russian new base of metal industry was established. In the 30's of the XIX century riveted joints appeared, almost because of the invention of punch press; in the 40's there the profiled metal sheet and rolling were developed. For the next hundred years all steel structures were manufactured by riveted technology. Steel is almost completely pushed out the structures made of iron, being a more advanced material in their properties (especially when working in tension) and better verifiable and machining.

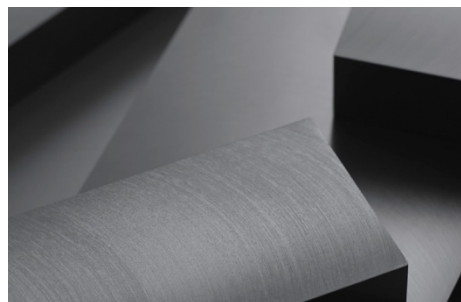

Figure 2.5 Steel. (Apple Inc. website)

Cast-iron constructions in the second half of the XIX century were applied only in the columns of high-rise buildings, to provide good resistance of iron compression.

In Russia before the end of the XIX century industrial and civil buildings were built with the brick walls and small bays, to overlap which there were used the triangular metal girders. The structural form of these trusses was gradually improved with braces and rivet joints instead of bolted connections.

At the end of the last century lattice frame-arch structures were used for covering large spans of buildings. Examples are covering of Sennoy market in Saint Petersburg (1884) span of 25 m, the Warszawskii market span of 16 m (1891), covering of the Gatchina railway station (1890) and others.

Greatest perfection with frame-arch design to cover the landing stages was reached at the Kievskii railway station in Moscow designed by V. Shukhov (1913-1914).



Figure 2.6 Frame-arch structure of Kievskii railway station in Moscow. (Wikipedia website)

In the design of these structures layout scheme, supporting and securing anchor riveted joints were developed.

In the second half of the XIX century significant development has been the metal bridge construction in connection with the growth of the railways. During the construction of bridges shape form of metal structures was developed and theo-

ry of design, calculation and technologies of manufacturing were improved. Design principles developed in bridge building, in fact were transferred into industrial and civilian objects. The founders of the Russian school of bridge construction are well-known engineers and professors S.V. Kerbedz, N.A. Belelyubsky, L.D. Proskuriakov.

The fifth period began from the end of the 20's.

Development of metallurgy already in the 30's allowed using stronger low alloy steel structures instead of the usual mild steel (siliceous steel for rail-road bridges).

By the end of the 40's riveted structures were almost completely replaced by welded, lighter, smarter and more cost-effective. (Metal structures 2010, pp.6-9)

2.2 Range and scope of the metal structures

Metal structures are used today in all types of buildings and civil engineering structures, especially for the purpose of large spans. The need for metal structures is extremely high and constantly increasing. Base to meet this need is a large amount of steel produced in Russia (in 1982 around 155 000 000 tons of steel was melted), plants of metal structures and specialized installers equipped with modern appliances, specialized design organizations and research institutes.

Depending on the structural form and purpose metal structures can be divided into four types.

- (1) Industrial buildings. Construction of single-storey industrial buildings made in the form of full metal or mixed frames in which it is the reinforced concrete columns, metal roof (tilt) and crane railways. All metal frames are mainly used in buildings with large span and equipped with heavy-duty overhead cranes. Frames of industrial buildings are the most complicated and metal consuming.
- (2) Large span buildings. Public buildings, theatres and some industrial buildings (hangars, aviation workshops, laboratories) have large spans (up to 100 – 150 m), which have to be constructed using metal. Systems

and constructive forms of large span are very diverse. It can be a beam, a frame, an arch, a hanging system, combined, with both planar and spatial systems. The design of public buildings meets high aesthetic requirements.

- (3) Bridges, viaducts, railways, motorways structures. As large-span coverage, bridges have a variety of systems: beam, arch, hanging and combined.
- (4) Leaf design in the form of tanks, gas tanks and bunkers. Metal structures have advantages, which allow using them in a variety of structures.

Metal structures have the following advantages:

- (a) Reliability of metal structures provides a close coincidence of their actual work (the distribution of stresses and strains) with the calculated predictions. Material of metal structures (steel, aluminium alloys) has a great uniformity of structure and fairly close agreement with the calculated assumptions about the elastic and elastic-plastic material work.
- (b) Ease. Metal structures are the most light of all the currently manufactured bearing structures (reinforced concrete, stone, wood, etc.). The density of the material is determined by:

$$c = \frac{p}{R} \quad [1/m] \quad (1)$$

(Where p – ratio, R – design resistance. The smaller the value c - the lighter construction is)

- (c) Production. Metal structures for the most part are made in factories with modern equipment that provides high quality manufacture. Installation of metal structures is produced by specialized organizations using modern technology and equipment.
- (d) Impermeability. Metals have not only considerable strength, but also a high density - impermeability to gases and liquids. Density of the metal and its compounds, carried out by welding, is a prerequisite for the production of gas tanks.

On the other hand metal structures have disadvantages that limit their use. To minimize these disadvantages special measures are necessary.

- (a) Corrosion. Not protected from the action of a humid atmosphere, and sometimes (even worse) the atmosphere, polluted corrosive gas, steel corrodes (oxidized), which gradually leads to its complete destruction. Under adverse conditions, this can happen in two or three years. Although aluminium alloys have a considerably greater resistance to corrosion in adverse conditions, they also corrode. Iron has a good corrosion resistance. Increase in the corrosion resistance of steel structures is achieved by the inclusion of special steel alloying elements, periodic structures coated protective films (paints, varnishes, etc.), as well as the choice of a rational form of constructive elements (without cracks and cavities that can accumulate moisture and dust), convenient for the cleaning and protection.
- (b) Small fire resistance. At $t = 200^{\circ} C$ steel begins to decrease elastic modulus, and at $t = 600^{\circ} - 1\ 000^{\circ} C$ steel is completely converted into the plastic state. Aluminium alloys go to a plastic state already at $t = 300^{\circ} C$. Therefore, the metal structure of the building, a fire hazard (warehouses with combustible or flammable materials, residential and public buildings), must be protected with fireproof linings (concrete, ceramics, special coatings, etc.).

During the design of steel structures the following basic requirements should be taken into account.

- (a) Operating conditions. Satisfaction specifies the design of the operating conditions and fundamental requirement for the designer. It is mainly determined by the system, the constructive form of construction and choice of material for him.
- (b) Less metal. The requirement to save metal is determined by his great need in all industries (machinery, transport and etc.) and the relatively high cost. Structures from the metal should be used only in cases when

its replacement by other types of materials (especially concrete) is irrational.

- (c) Transportability. In connection with the manufacture of metal structures, as a rule, in the factories, followed by transportation to the construction site, builders must be able to carry metal structures in their places by parts (elements of dispatch), with appropriate vehicles.
- (d) Manufacturability. Structures must be designed to meet the requirements of manufacturing techniques and assembly-oriented most modern and efficient processing methods to ensure maximum reduction of labour.
- (e) Speed installation. The design shall comply with the ability to build it in the shortest term, taking into account the existing installing hardware.
- (f) Durability is determined by the terms of its physical and moral deterioration. Physical deterioration of metal structures mainly depends on the corrosion process. Obsolescence is associated with changes in the operating conditions.
- (g) Aesthetics. Design regardless of their purpose should have harmonious forms. This is a particularly important requirement for public buildings and structures.

The basic principle of the Russian school of construction design is to achieve the three main indicators: saving material, increasing labour productivity in manufacturing and reducing the complexity and timing of the installation, which determine the cost of construction. Despite the fact that these measures are frequently in the implementation of conflict (for example, the most economical on fuel steel design is often the most time-consuming to manufacture and install), the experience in the development of metal structures confirms the feasibility of this principle. (Metal structures, 2010)

Saving of metal in metal structures is achieved through the implementation of the following key areas: application in structures of low-alloy and high-strength steels, the use of the most cost-rolling and cold-formed sections, research and implementation in the construction of modern, efficient structural forms and systems (spatial, prestressed, hanging, tubular etc.), improving the methods of calculation and finding optimal design solutions using computer technology.

3 National Codes in the United Kingdom (Europe) and Russia

English engineers used the best European level in accordance with European Standards, ICAO Standards, and Russian Law and Russian National Codes. Russian engineers took into consideration Russian Law, Russian National Codes and research materials from the English side. In both cases where conflict exists the higher level standard takes precedence.

3.1 The United Kingdom and Eurocodes

Eurocode loading code, EN 1990, section 3.2 (2) states that the following design situations should be considered:

“Accidental design situations, which refer to exceptional conditions applicable to the structure or to its exposure, e.g. to fire, explosion, impact or the consequences of localised failure.”

Eurocode EN 1991-7-2006 outlines the structural engineering design to satisfy the following code statement:

“The structures are designed such that they are inherently robust and will not suffer damage or collapse that is disproportionate to the cause.”

3.1.1 Key elements of the Eurocode design

Section A.8 of EN 1991-7 2006 outlines that a force of 34 kN / m² shall be applied in both the vertical and horizontal directions (considered independently) to elements designated as key elements, and that where practicable additional load paths are to be provided for additional redundancy to minimise the likelihood of a brittle failure mechanism. In addition an impact force of 150 kN is to be applied to columns designated key elements one meter above the floor level.

The above loadings are to be considered at ultimate limit state.

Those standards for the designing of roof structure are listed below in Table 3.1.

Table 3.1 Eurocode system (Ramboll report, 2011)

Eurocode	Description
BS EN 1991-1-1	Eurocode 1: Actions on structures – Part 1-1: General actions – Densities, self-weight and imposed loads
BS EN 1991-1-2	Eurocode 1: Actions on structures – Part 1-2: General actions – Actions on structures exposed to fire
BS EN 1991-1-3	Eurocode 1: Actions on structures – Part 1-3: General actions – Snow loads
BS EN 1991-1-4	Eurocode 1: Actions on structures – Part 1-4: General actions – Wind actions
BS EN 1991-1-5	Eurocode 1: Actions on structures – Part 1-5: General actions – Thermal actions
BS EN 1991-1-6	Eurocode 1: Actions on structures – Part 1-6: General actions – Actions during execution
BS EN 1991-1-7	Eurocode 1: Actions on structures – Part 1-7: General actions – Accidental actions
BS EN 1993-1-1	Eurocode 3: Design of steel structures – Part 1-1: General rules and rules for buildings
BS EN 1993-1-2	Eurocode 3: Design of steel structures – Part 1-2: General – Structural fire design
BS EN 1993-1-3	Eurocode 3: Design of steel structures – Part 1-3: General – Cold formed thin gauge members and sheeting
BS EN 1993-1-8	Eurocode 3: Design of steel structures – Part 1-8: General – Design of joints
BS EN 1993-1-9	Eurocode 3: Design of steel structures – Part 1-9: General – Fatigue strength
BS EN 1993-1-11	Eurocode 3: Design of steel structures – Part 1-11: General – Design of structures with tension components
BS EN 1994-1-1	Eurocode 4: Design of composite steel and concrete structures – Part 1-1: General – Common rules and rules for buildings
BS EN 1994-1-2	Eurocode 4: Design of composite steel and concrete structures – Part 1-2: General – Structural fire design
BS EN 1994-2	Eurocode 4: Design of composite steel and concrete structures – Part 2: Bridges

Basically there are some different methods during the calculation process when using different types of Technical Standards but the result should be approximately equal. However British and Russian engineers get dissimilar structural frames. In fact project managers decided to take the last calculations due to their higher bearing capacity and accordance with Russian Standards.

3.1.2 Strategies for accidental design situations

EN 1991-1-7 2006 (Eurocode 1 – Actions on Structures, Part 7: General actions - Accidental Actions) describes strategies for dealing with the design situations. Section 3 of EN 1991-1 includes the following Chart 3.1 showing the strategies to be considered:

Chart 3.1 Accident strategies (Ramboll studies) (Ramboll report, 2011)

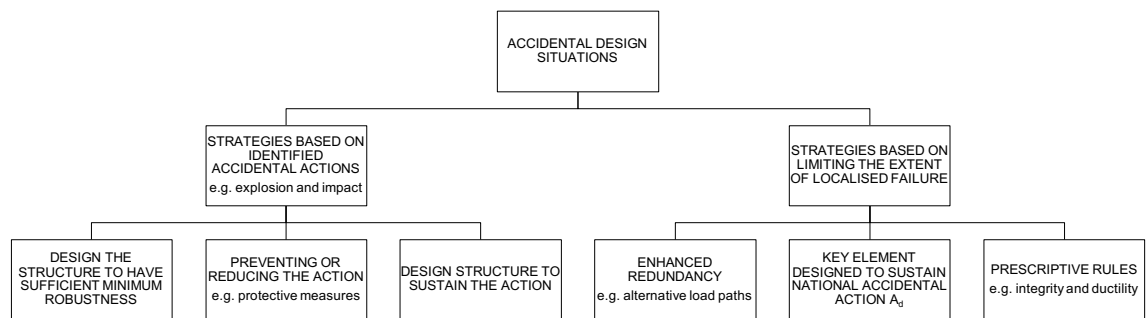

3.1.3 Risk assessment

A detailed risk assessment outlines the robustness design risks to the project and allows the designer to understand the critical considerations with regard to both consequences of failure and likelihood of event.

Annex A of the code provides a system for classifying structures by the consequence of their failure.

All structures in the Pulkovo Passenger Terminal are categorised as consequence class 3 (All buildings where the public is admitted in significant numbers). Thus the following approach, as described in section A3, has been adopted:

“For Class 3 buildings - A systematic risk assessment of the building should be undertaken taking into account all the normal hazards that may reasonably be foreseen, together with any abnormal hazards.”

3.1.4 Risk assessment methodology

The risk assessment will be qualitative, rather than quantities, as suggested by the Department for Communities and Local Government Guide to the use of EN1991-1-7 because sufficient data on the probability of the various hazards is very unlikely to be available. The steps in the risk assessment are given below in Chart 3.2. (Ramboll report 2011, pp. 628-629)

Chart 3.2 Risks steps (Ramboll report, 2011)

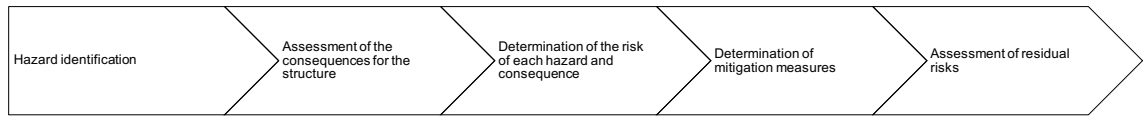

3.1.5 Structural design risk mitigation measures

All structures should be designed to include the provisions for Class 2 buildings, as described in the code. These include:

- Horizontal ties for framed and load-bearing wall construction together with vertical ties in all supporting columns and walls;
or:
- Checking to ensure that the building remains stable upon the notional removal of each supporting column once at the time or each beam supporting a column, or any nominal section of load-bearing wall and that any local damage does not exceed 100 m² of floor;
and:
- Where the notional removal of such columns and sections of walls would result in an extent of damage in excess of a specified limit, such elements are designed as "key elements";

3.2 Russian Federation codes and standards

The Russian National Codes do not have prescriptive guidance for robustness and disproportionate collapse. However, there is a local Saint Petersburg Territorial Building Standard, which outlines progressive collapse design requirements for public high-rise buildings. There is also a Moscow State Construction Norm that outlines the progressive collapse requirements for high-rise buildings in Moscow.

The details of both of the above local standards are presented below.

3.2.1 Saint Petersburg Territorial Building Standard

The Territorial Building Standard for public high-rise buildings in Saint Petersburg – TSN 31-332-2006, which applies to public buildings greater than 50 m in height, the Pulkovo main terminal is only 29.1 m high above the ground, total structural height of 36 m from basement level. Therefore the TSN does not strictly apply to the Passenger Terminal Facilities at Pulkovo airport, however it does provide a useful background to Russian requirements against progressive collapse.

- (1) High-rise buildings should be protected from the progressive (chain) collapse in case of local failure of load-bearing structures as a result of emergency situations - seismic effects, dangerous meteorological phenomena, explosions outside or inside the building, fire, accident or major damage to the bearing structure as a result of defects in materials, poor work performance.
- (2) The stability of buildings against progressive collapse should be checked by calculation and provided constructive measures that contribute to the development of bearing structures and their sites of plastic deformation under load. Calculation of the stability of the building is recommended for a special combination of loads, including permanent, long-term, short-term effects and one of the following situations:
 - a. Damage to floors with a total area up to 40.0 m²,
 - b. Excessive rainfall base,
 - c. The impact of horizontal load to vertical load-bearing structures - 35 kN for the columns and 10 kPa at the surface of walls within a single floor,
 - d. The location of sinkholes in diameter 6.0 m in any place under the foundation of the building.
- (3) To analyse and design the buildings against progressive collapse it is recommended to use the spatial computational model that can take the elements that are under normal operating conditions, load bearing, and in the presence of local damage to actively participate in the redistribution of the load.

- (4) The primary means of protecting buildings against progressive collapse - the reservation strength load bearing elements, providing the necessary load capacity of columns, beams, diaphragms, discs and joints overlapping structures, creating a continuous slab, increasing the plastic properties of the linkages between building blocks, the inclusion in the work space of non-structural elements.
- (5) For high-rise buildings it is recommended to use monolithic and precast-monolithic slabs, which must be securely connected to the vertical supporting structures of the building bonds. The links connecting the floors with columns, girders, diaphragms and walls, must keep the overlap of the fall in the case of its destruction) to the underlying floor. Communication should be calculated on the standard weight of a half span overlap with it located on the floor and other structural elements.
- (6) In the case of local failure of one vertical structures - walls or columns, which are the mainstay for the monolithic ceiling, should not happen collapsed ceilings. In this case the deflection and the opening of crack the ceiling is not limited. Number and location of additional reinforcement in this case are determined by calculation. This fixture can be taken into account in the calculation of the operating loads.

3.2.2 Moscow State Construction Norm

Local Moscow State guidance does exist for high-rise structures greater than 75 m in height. As with the Saint Petersburg Codes, The Moscow Construction Norm (MGSN 4.19-05) was developed for high-rise construction and therefore does not strictly apply to the Passenger Terminal Facilities at Pulkovo airport, however it does provide a useful background to Russian requirements against progressive collapse (Section 6: “Measures for protection from progressive failure”).

MGSN states: “Buildings must be protected against progressive failure caused by local failure of bearing structures, as a result of emergency situations.” It then lists the specific emergency situations that should be considered, including:

- Dangerous meteorological phenomena;
- Formation of solution cavities and depressions below buildings;
- Explosions outside and inside the building;
- Fire;
- Defective materials or workmanship;
- Prevention of progressive failure to be checked by calculation considering plastic deformations of structural components under ultimate limit state conditions.

MGSN Section 6.1.3 states: “Building stability shall be based on special combination of loads including dead and sustained loads”, and goes on to list the failure modes to be considered:

- Removal of two intersecting walls;
- Removal of column in one floor;
- Collapse of part of floor on one level.

All of which are to be considered when the resulting local failure would be greater than 80 m². It advises that only the most dangerous local failure scenarios are considered.

MGSN recommends the calculation of progressive collapse modes using normative values of material strengths, load factors of unity and no limits on deflection and crack width.

MGSN recommends the following measures to prevent progressive collapse of buildings:

- Provide reserve strength in the bearing elements;
- Achieve fixity and continuity of floor reinforcement;
- Design tie anchorages to allow development of plastic strength;
- Ties and links shall be designed to bear normative weight of half the floor;
- Inclusion of non-load bearing elements in the extreme case.

Section 6.1.3 also limits the amount of damage to a “local failure area” of 80 m².

Russian Codes for the designing of roof structure are listed below in Table 3.2.

Table 3.2 Russian Technical Standards

Code	Description
SNIP 2.01.02-85*	Fire safety codes
SNIP 2.01.07-85*	Loads and impacts
SNIP II-23-81*	Steel structures
SNIP 11-26-76	Roofs
SP 53-102-2004	General regulations for designing steel structures
GOST 23118-99	Structural metalwork. General specifications
GOST 23118-99	Steel construction structures. General technical specification
GOST 26047-83	Building steel structures
GOST 27772-88	Rolled Products for Structural Steel Constructions
TSN 21-304-2003	Public Buildings: Fire Safety Requirements

4 Development, Calculation and Applied Software

English design process took a lot of time from the concept to structural design of the roof. The coordinator company from the beginning of the design development until the end was Ramboll Group A/S.

First of all engineers were thinking about the process from the architectural idea to the structural parts of the roof. There were many ideas and types of structure details.

UK designers thought about the type of the structure. Versions changed during the design process because of sophisticated approach to details like roof-lights and weld sequences for columns heads.

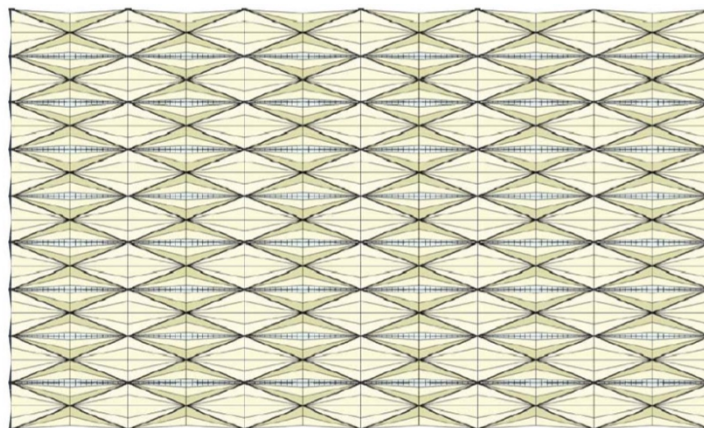

Figure 4.1 Architectural plan of the roof (Ramboll report 2011, p. 570)

The biggest challenge was to invent a structure and roof covering so that it would be easy for winter maintenance during snow period. It was complicated to decide how this frame space would be operated in north climate winter conditions and how to provide roof access. (Ramboll report 2011, pp. 517-518)

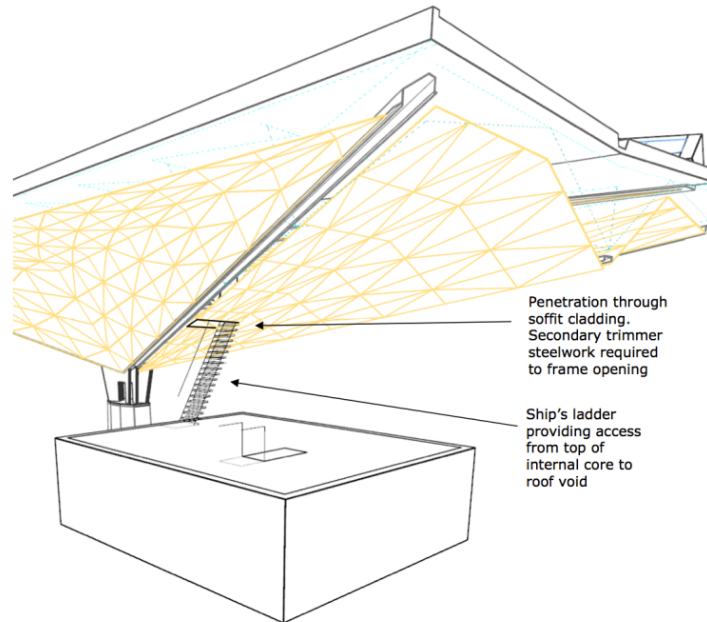

Figure 4.2 Roof access system (Ramboll report, 2011)

The second priority was to integrate engineering networks like fire systems, lighting and maintenance bridges to the space frame.

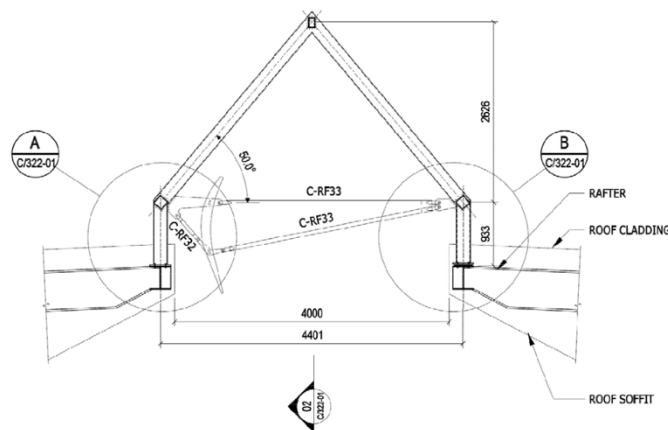

Figure 4.3 Roof-light section (Ramboll report 2011, p. 61)

Before calculation English engineers checked Eurocodes, ICAO Standards, Russian Technical Standards and chose the most relevant ones to make calculation as precisely as possible.

The main challenge was to make such an efficient columns' head (Figure 4.4) that a big metal structure would bear on it safely in wide spans and this will enable much space for terminal facilities. (Ramboll report 2011, pp. 583 - 588)

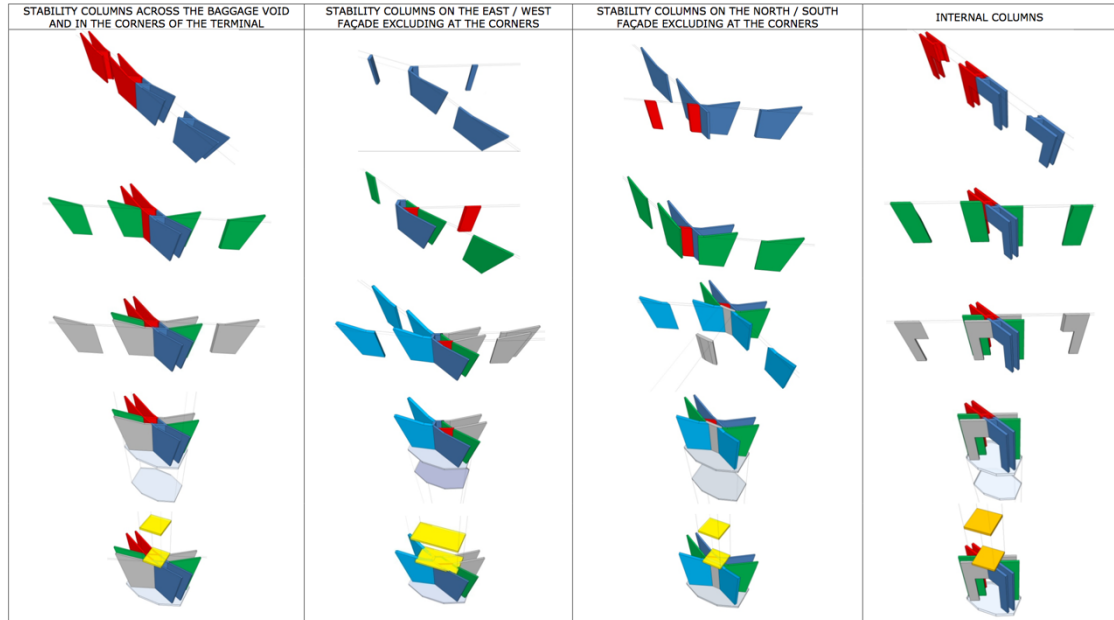

Figure 4.4 Development of columns' head (Ramboll report 2011, p. 47)

After the decision was made, engineers used Lira software to calculate the structure. A special company (BMT Fluid Mechanics Limited) were asked to make calculations of snow and wind using fluid mechanics technology. This company made huge work on this and special experiment. They built the terminal model and put it in the wind tunnel. There were over 200 control points located in the model. Fluid Mechanics method was applied.

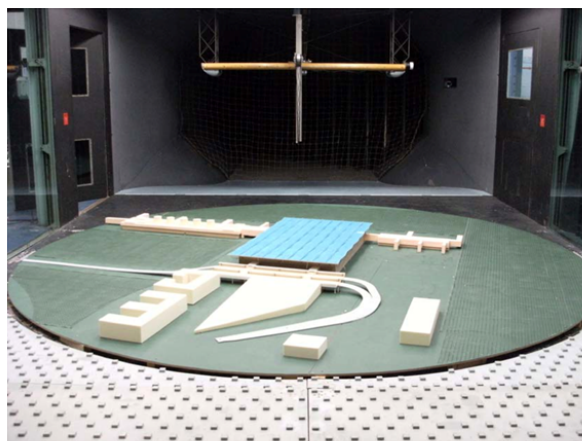

Figure 4.5 Terminal model in the wind tunnel (BMT Fluid Mechanics Limited)

Before calculations a crosscheck of SNIP (Russian National Code system) and Eurocodes parameters was made to ensure that the highest quality indicators were taken into consideration. Wind and snow loads are presented in Appendix A. (BMT Fluid Mechanics Limited report pp. 204 - 489)

Snow loads were another question because of wind. Designers thought how to maintain the roof because in case of a huge amount of snow it will be necessary to make cleaning of some parts and reload the roof to prevent the collapse.

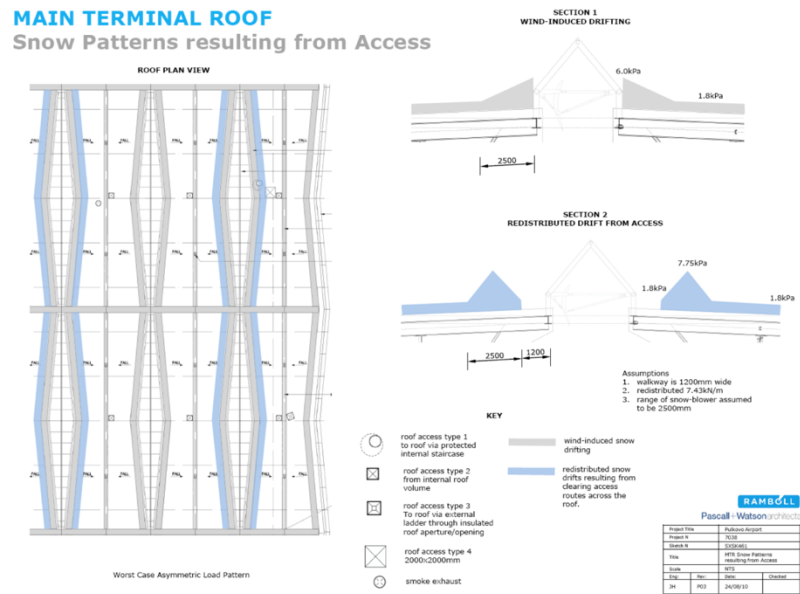

Figure 4.6 Snow patterns resulting from access (Ramboll report 2011)

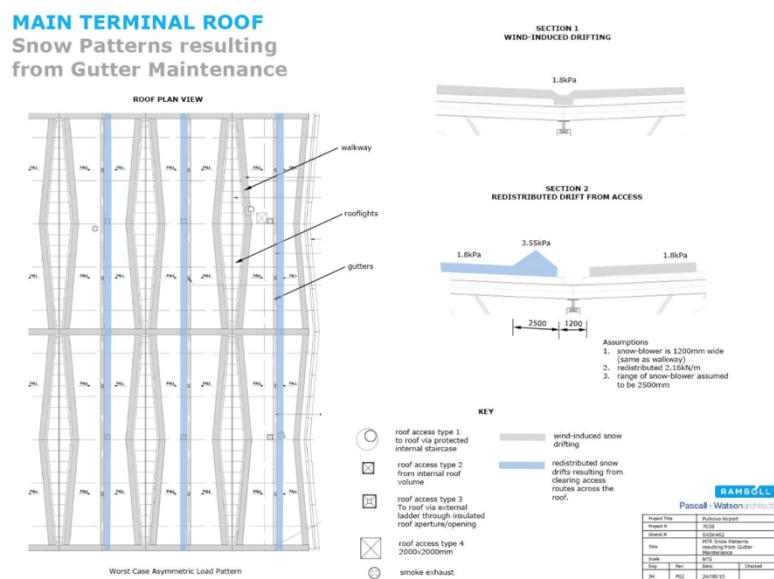

Figure 4.7 Snow patterns resulting from gutter maintenance (Ramboll report)

The results of the design were transferred to NCG and project managers asked for additional work to ensure the bearing capacity of the roof structure.

Russian engineers made a new model for SCAD Office software and new calculations. They changed the configuration of triangular trusses to the inverted scissors trusses. Moreover they changed the cladding structure and finally got a new result.

4.1 English combination of loads

London designers used both Russian National Codes and Eurocodes to understand the correct values of loads. Groups of loads are presented below in the tables. (Ramboll report 2011, pp. 141-145)

Table 4.1 Gravity loads (Ramboll report, 2011)

Item	Specified values	Comments
Roof Decking	0.85 kPa	Includes allowance for: 0.16 kPa Kalzip profile 0.10 kPa Standing seam sheeting 0.34 kPa Mineral wool insulation 0.25 kPa Acoustic insulation
Steelwork	Self weight of material	Self weight applied to all members based on material and frame section properties
Roof-light	1.25 kPa full specified	Applied over pitched area elements representing the roof-light
Roof-light	0.6 kPa Reduced	Applied over pitched area elements representing the roof-light
Ceiling	0.23 kPa	Includes allowance for: 0.10 kPa Perforated aluminium 0.02 kPa Acoustic insulation 0.10 kPa Secondary steelwork 0.20 kPa Access gantries(applied over 5% roof area per bay)
Ceiling	0.12 kPa	Assumed 50% reduction of full design value
Services	0.5 kPa	Assumed value
Services	0.1 kPa	Assumed value
Imposed load	0.65 kPa	Instantaneous imposed load – includes allowance for 3kPa imposed load on roof gantries
Imposed load (sustainable)	0.55 kPa	Sustained imposed load includes allowance for 1 kPa imposed load on roof gantries
Snow load	See loading document for snow load magnitudes and distribution	
Snow load	from wind tunnel reports	50% reduction for sustained loads

Table 4.2 Lateral loads (Ramboll report, 2011)

Item	Value	Comments
Wind load	See loading document for snow load magnitudes and distribution from wind tunnel reports	All wind pressures are applied as uniformly distributed area loads to: façade panels (spanning between windposts), exposed roof soffit panel (spanning between roof restraint steelwork) and roof upper surface panels (spanning between rafters). Internal RC frame slabs are assumed not to provide lateral restraint to façade. Wind panel pressures obtained from detailed wind tunnel testing.

Table 4.3 Thermal loads (Ramboll report, 2011)

Item	Value	Comments
Expansion	+ 59° C	Construction phase assumes external and unprotected from the effects of solar radiation. Sustained values neglect thermal gains from solar radiation and deviations in average daily temperature.
Expansion	+ 20° C	
Contraction	- 39° C	
Contraction	- 20° C	Operation phase assumes internal structure is insulated, permanently heated and equipped with mechanical HVAC systems and protected against solar radiation.
Expansion	+ 29° C	
Contraction	+ 11° C	

Table 4.4 Resistant loads (Ramboll report, 2011)

Item	Value	Comments
Resistant force	Varies between 25 kN – 40 kN dependent on magnitude of compressive force in member.	Applied in a single roof bay to assess implication on primary steel elements and plan bracing.

Table 4.5 Imposed load patterns (Ramboll report, 2011)

Description	Comments
Global downward pressure	Full dead loading. Imposed loads applied over entire roof surface
Maximum East / West cantilever tip deflection	Full imposed loading applied in areas which increase E / W cantilever deflection
Maximum internal bay longitudinal sag	Full dead and live loading applied in areas which increase internal bay longitudinal sag
Maximum diagonal truss midspan deflection	Full imposed loading applied in areas which increase deflection as internal cross-over points (at

	midspan of diagonal trusses)
Maximum bay twist	Full imposed loading applied in areas which induce maximum bay twist
Maximum corner bay tip deflection	Full imposed loading applied in areas which increase deflections at corners of roof structure

Table 4.6 Snow load patterns (Ramboll report, 2011)

Item	Description	Comments
Wind tunnel	Global downward pressure	Full snow loading applied over entire roof surface
Clearing pat	Snow clearing pattern for removal from walking and gutter	

4.2 Truss design development

Usually a building has a frame made of reinforced concrete or steel. The choice of materials depends on the building's size, loads and time of construction. Sometimes the building can have a mixed frame with reinforced columns and steel envelope. Engineers make a decision on structural materials after feasibility studies.

As part of the structural design for the new terminal's roof several options were developed and evaluated by English engineers.

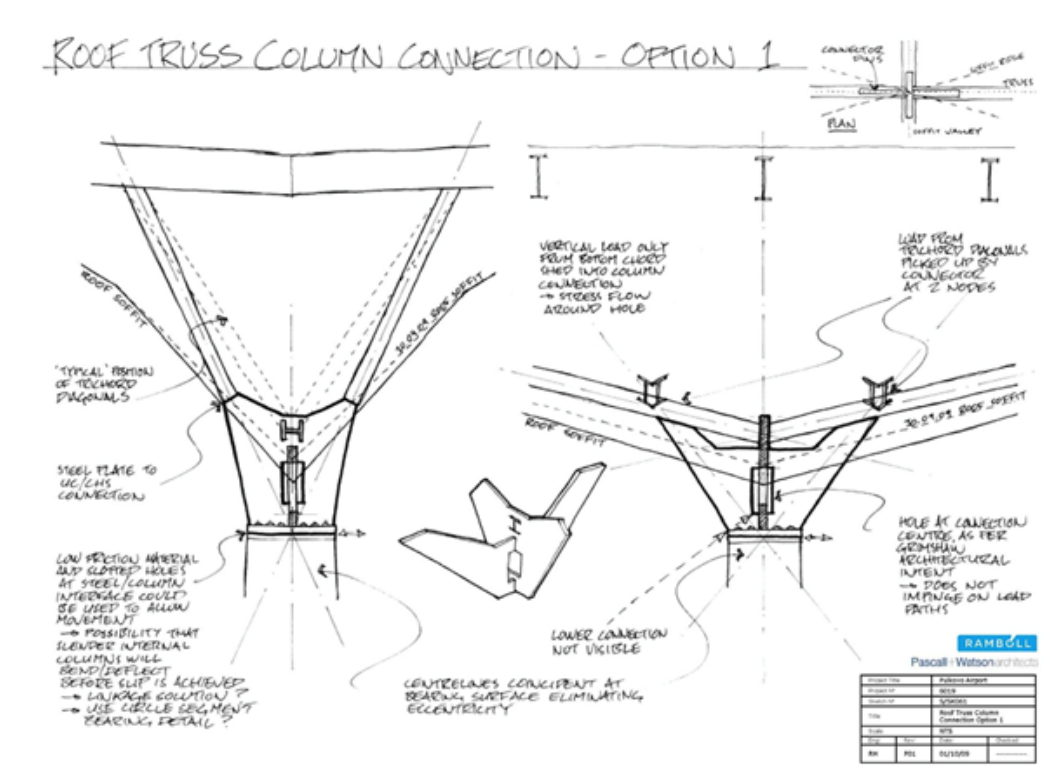

ROOF TRUSS COLUMN CONNECTION - OPTION 2

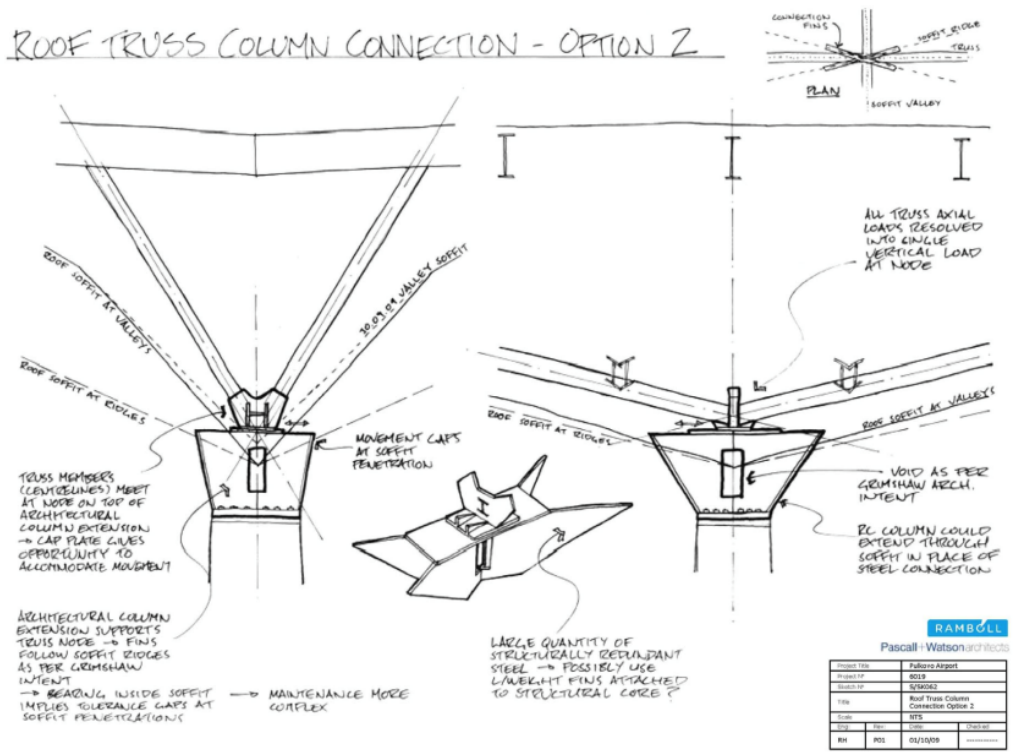

FLIPPED TRUSS CONNECTION DETAIL

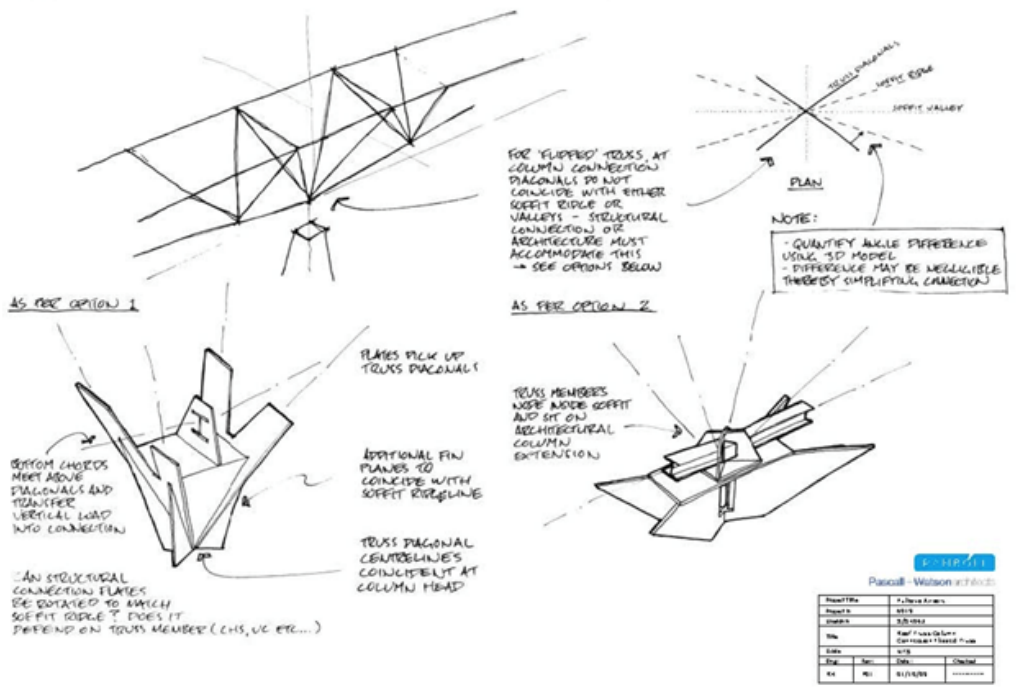

Figure 4.8 Truss and column sketches (Ramboll report 2011, pp. 561-563)

Each of the five stability options identified as being viable solutions were evaluated against the above criteria, with weighing applied depending on the im-

portance. The resulting matrix formed the basis for the final stability system selection.

Each of the options and the resulting matrix are described below.

4.2.1 Option 1 - Concrete roof box girder

The concrete box girder option consists of a closed structural section with internal stiffeners. The girder can be constructed from either a series of pre-stressed concrete units or reinforced cast in place concrete. The figures below show the cross-section shape and proposed construction techniques for both the pre-stressed and in-situ concrete options.

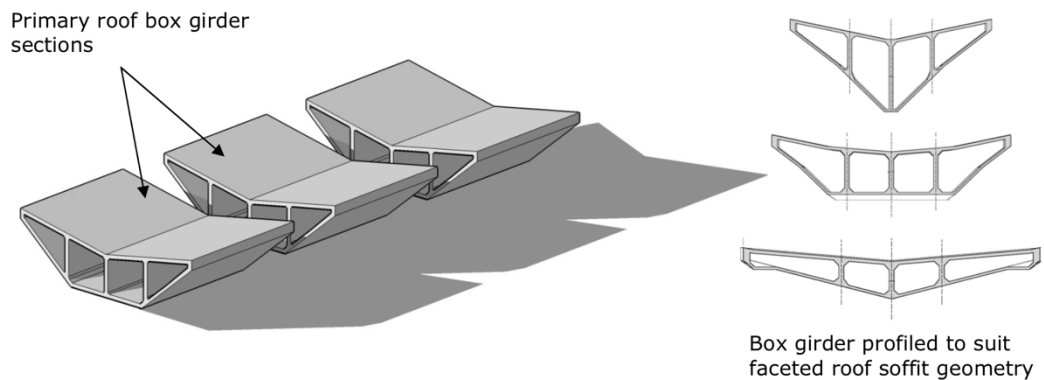

Figure 4.9 Concrete box girder roof structure (Ramboll report, 2011)

The main benefit of this option is its inherent torsional rigidity. Consequently, the number of restraining elements required in both the permanent and temporary condition will be minimised.

Another benefit is realised by the facility to profile the underside of the box girder to align with the architecture roof soffit. This will minimise the amount of secondary steelwork required.

The main drawback with this solution is its weight. Concrete structures are inherently heavier than an equivalent structure constructed in steel. An increase in roof tonnage has a negative impact on column and foundation loads and as a consequence, additional material costs will be incurred. (Ramboll report 2011, p. 542)

4.2.2 Option 2 – Steel box girder

A box girder fabricated of steel plate has also been considered. This option realises the high torsional rigidity benefits of the concrete box girder described above but has a reduced overall weight.

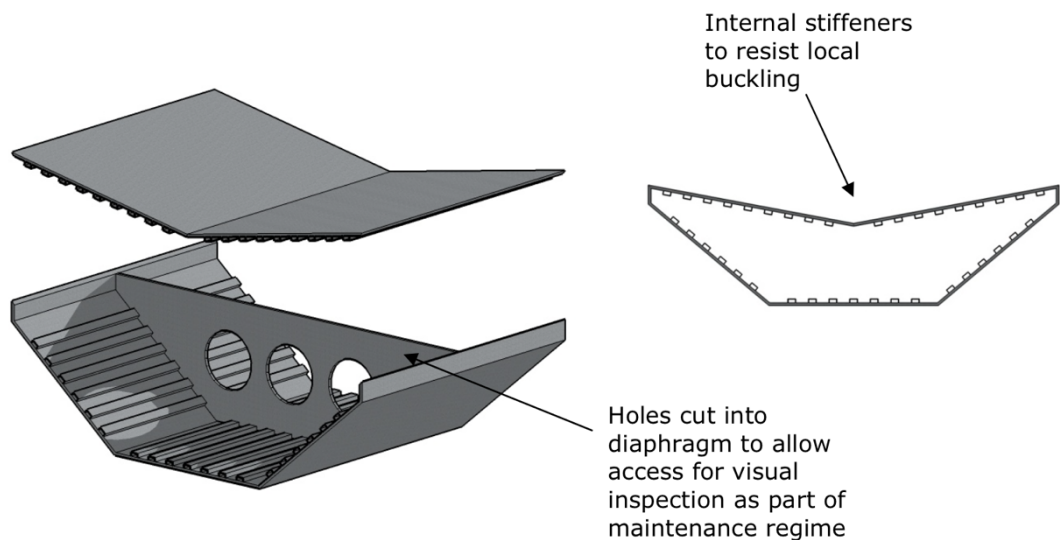

Figure 4.10 Steel box girder roof structure (Ramboll report, 2011)

The main drawback of this option will be the difficulty in fabrication. The bespoke 3 dimensional geometry will be costly to implement. (Ramboll report 2011, p. 543)

4.2.3 Option 3 – Steel plate girder

A plate girder option has been considered due to its simplified geometry and potentially low piece count and fabrication advantages. However, this benefit is not realised for a number of reasons.

The main drawback with this option is the low torsional rigidity. To provide lateral restraint, deep links will be required at close centres. These will increase the overall tonnage of the roof that will have a negative impact on column and foundation loads. Furthermore, the closely spaced link beams will obscure roof-lights.

Another drawback is the fact that the plate girders bear little relation to the roof soffit geometry. Consequently, a large amount of secondary steelwork will be required to suspend the roof soffit. (Ramboll report 2011, p. 544-545)

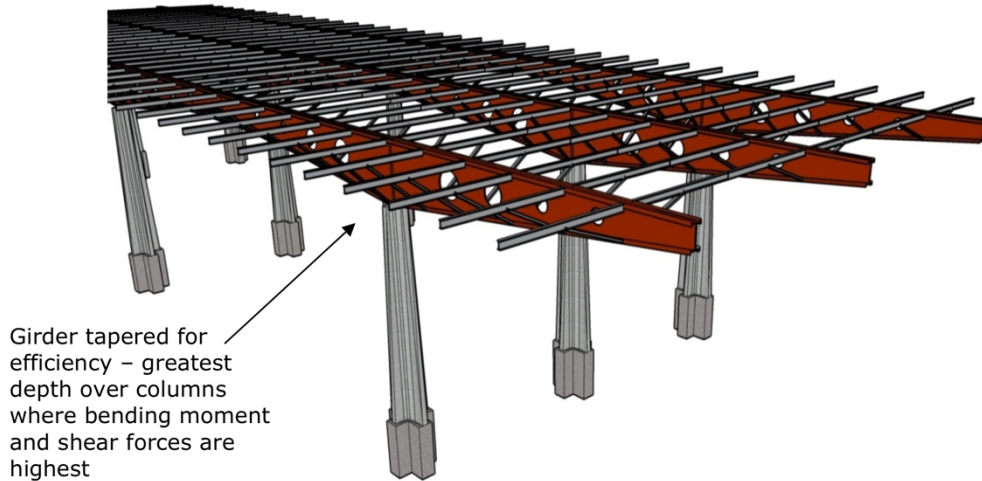

Figure 4.11 Isometric views of steel plate girder roof structure option (Ramboll report, 2011)

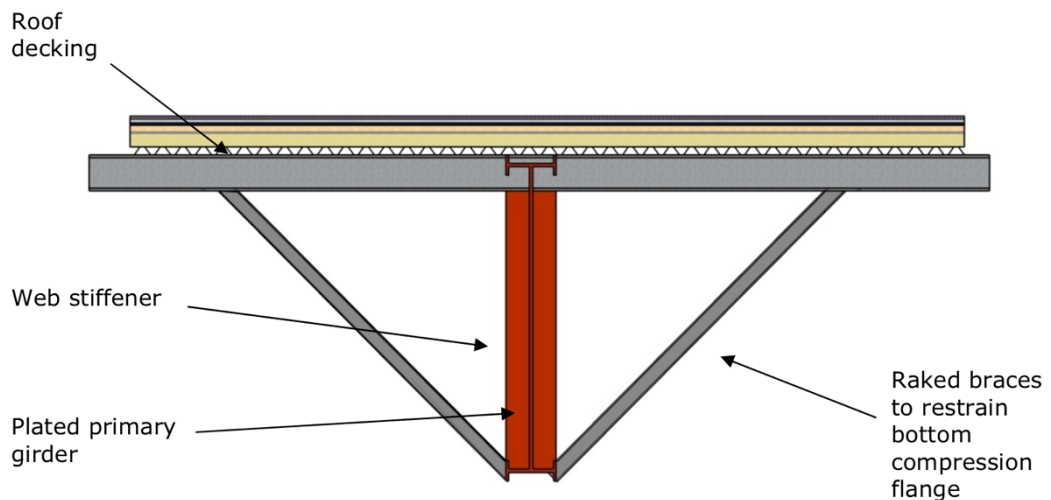

Figure 4.12 Steel plate girder roof structure option (Ramboll report, 2011)

4.2.4 Option 4 – Planar truss

Planar steel trusses offer a lighter way of spanning long distances than both the plated and box girder solutions described above. A solution whereby planar trusses span both longitudinally and transversely has been considered.

Whilst providing an inherently lightweight primary structure, this option does present a number of drawbacks.

As with the plated girder option, planar trusses have a low torsional rigidity. Consequently, a high number of deep restraining link beams will be required to prevent lateral buckling. These would be arranged at close centres and would obscure the architectural roof-lights.

Furthermore, this solution bears little relation to architectural faceted soffit geometry. This will necessitate a large amount of secondary steelwork to suspend the roof soffit. (Ramboll report 2011, p. 546)

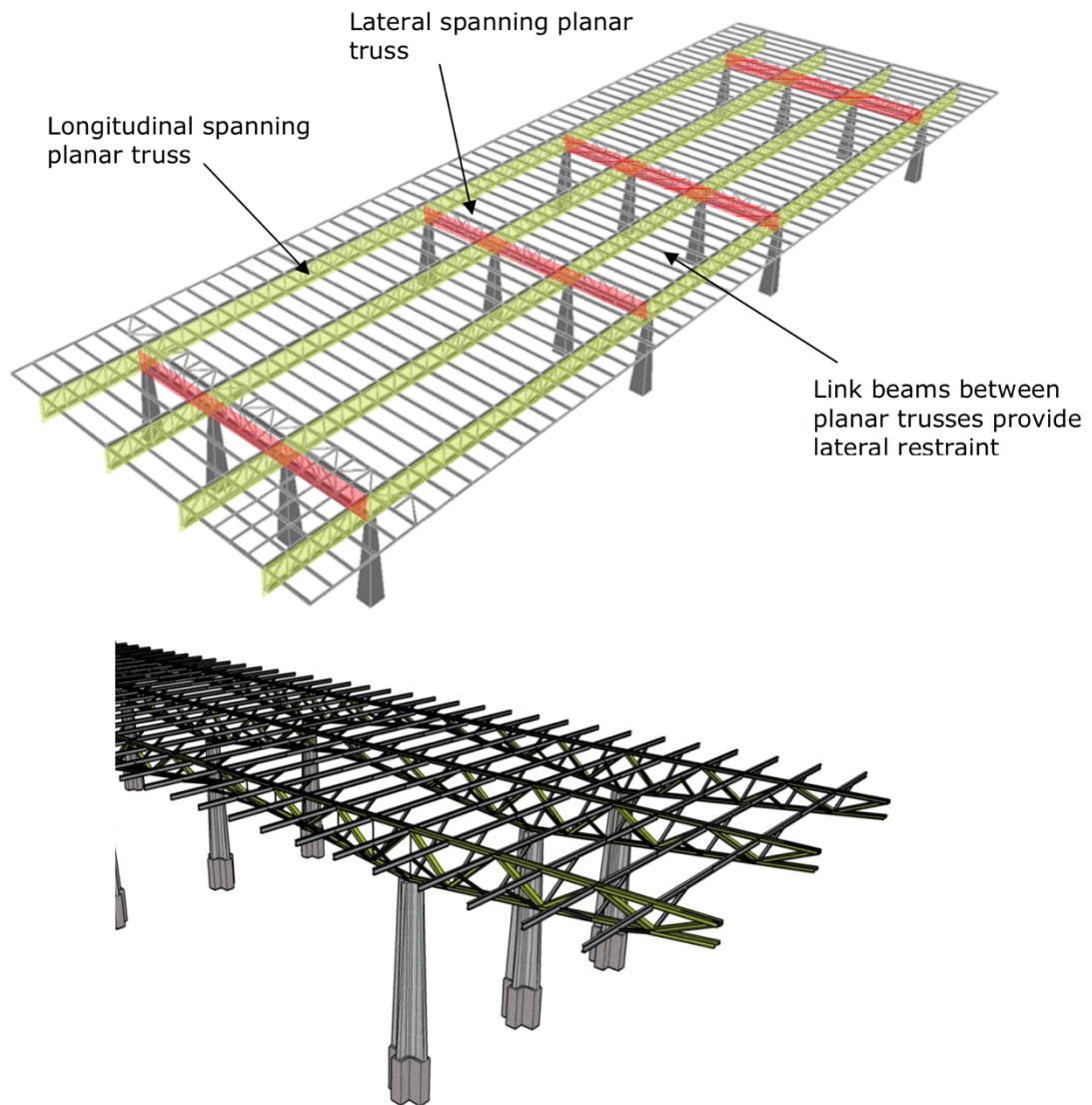

Figure 4.13 Isometric views of planar truss roof structure option (Ramboll report, 2011)

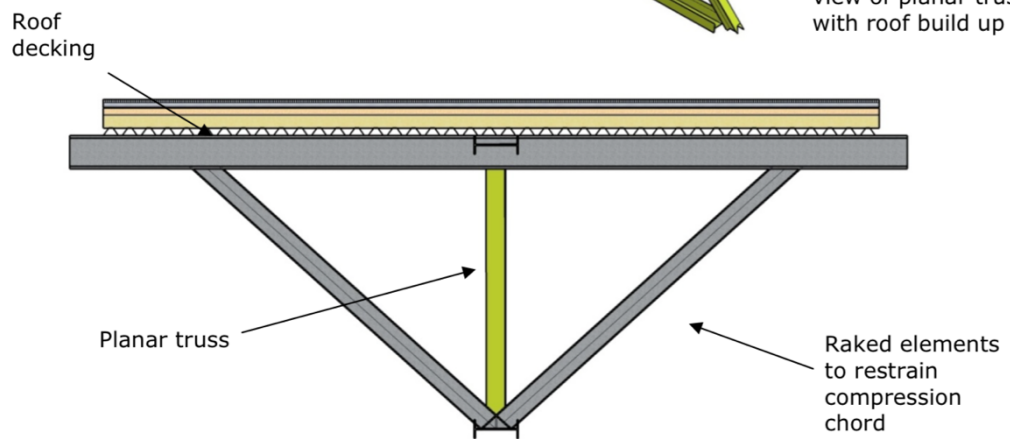
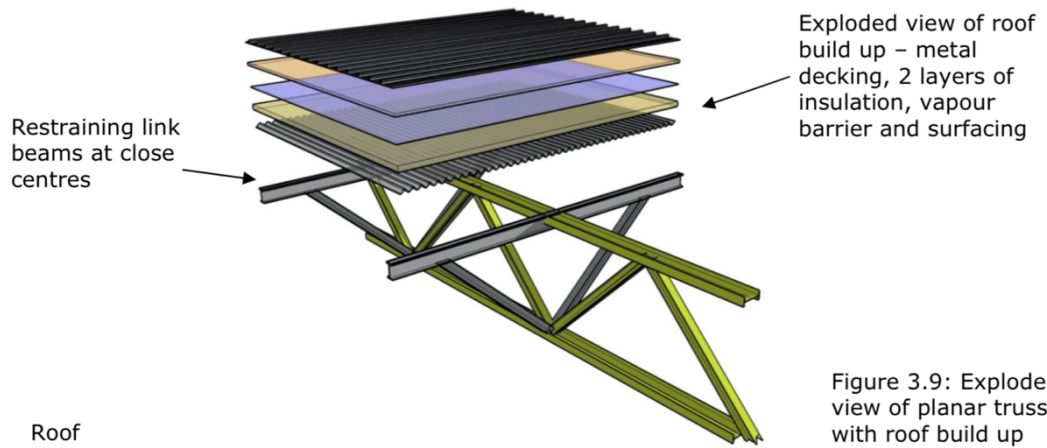

Figure 4.14 Section through planar truss (Ramboll report, 2011)

4.2.5 Option 5 – Trichord truss

To retain the vertical stiffness and torsional rigidity advantages presented by the planar truss and box girder options respectively, a trichord truss option has been developed.

Identified as most likely to meet the design requirements the trichord truss was taken forward for further development. This is described in the next section.

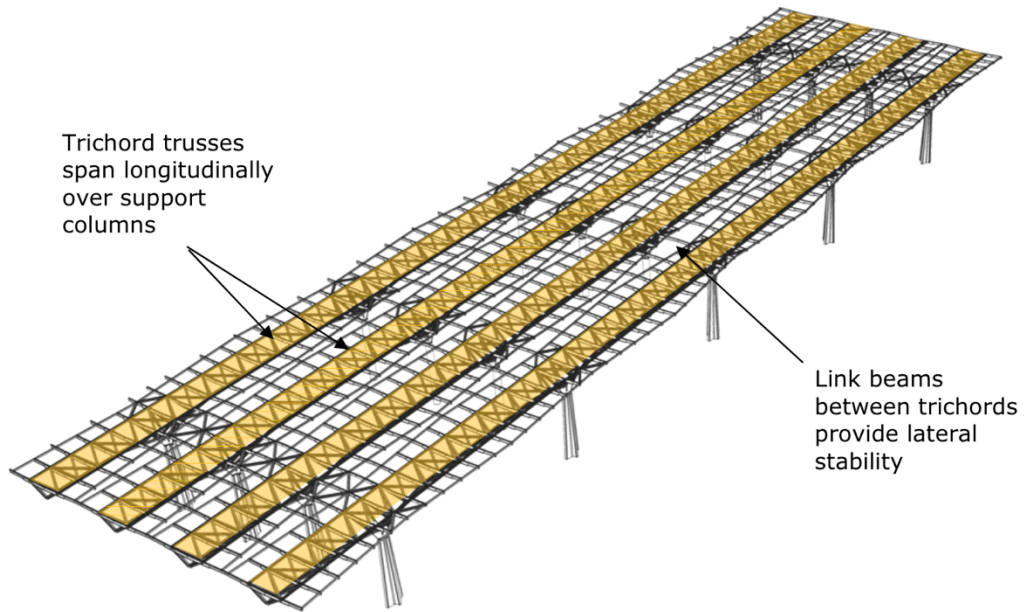

Figure 4.15 Trichord truss roof structure option (Ramboll report, 2011)

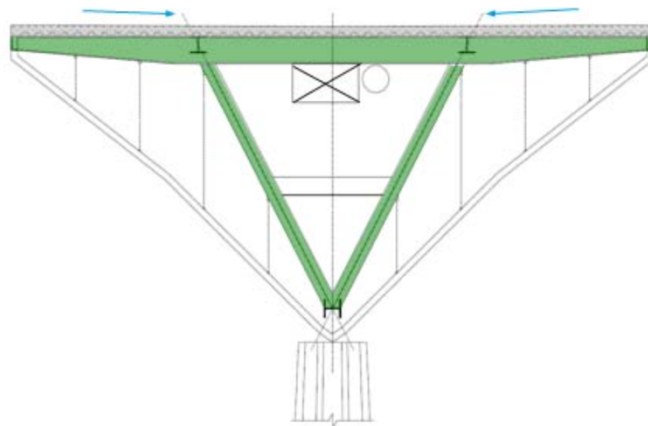

Figure 4.16 Trichord truss section (Ramboll report, 2011)

4.2.6 Trichord truss geometry evolution

The trichord solution provides a structurally efficient means of spanning the roof loads large distances between support columns. However, the complex 3-dimensional geometry complicates fabrication and alignment with both architectural roof-lights and soffit cladding.

Option 1 – Base option, Triangular Prism

The triangular prism geometry is the simplest of the trichord options considered. Maintaining a constant depth and width along its length maximises repetition and simplifies fabrication.

The main drawback is the lack of alignment with the architectural soffit and roof-light. This will require additional secondary steelwork which increases piece count, overall tonnage and complicates installation.

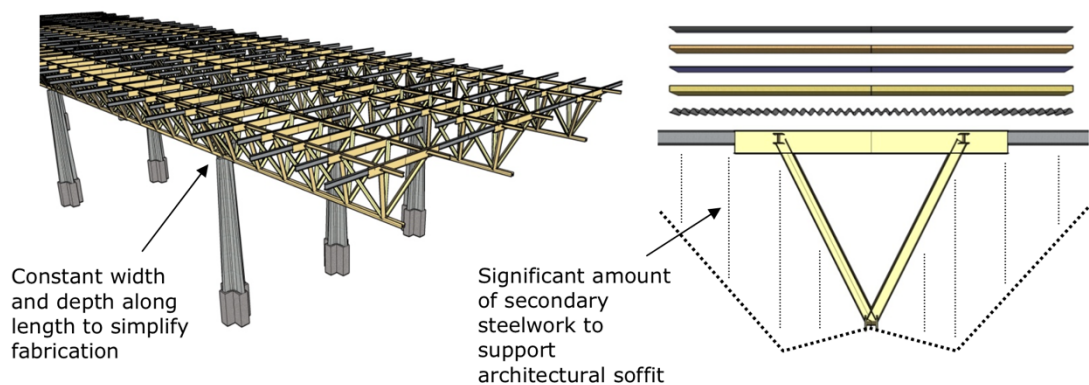

Figure 4.17 Isometric and section through trichord option 1 (Ramboll report, 2011)

Option 2 – Soffit Driven Geometry

Increasing the overall width of the primary structural element and faceting the structural soffit improves alignment with the roof-lights and architectural roof soffit geometry respectively. This realises benefits by reducing the amount of secondary steelwork.

Further benefits are attributed to a tapering truss depth along its length. This both mimics the architectural soffit and provides structural efficiency by concentration of material in more highly stressed regions.

The principal drawback is the fabrication complexity due to the irregular three-dimensional geometry. In addition more diagonal elements are required to triangulate the extra node points, increasing the piece count and overall tonnage.

Also, by increasing the overall width, the angle of the side plane elements becomes shallower rendering them less efficient at carrying vertical loads. This has a detrimental effect on the overall tonnage.

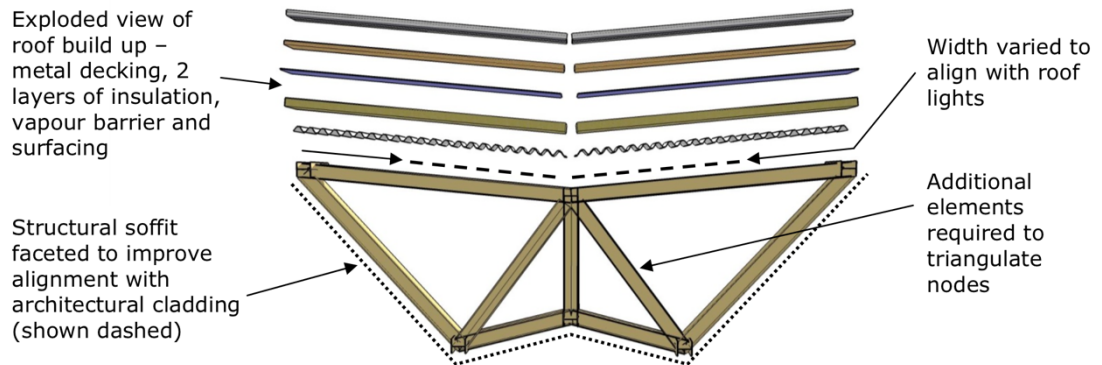

Figure 4.18 Section through trichord (Ramboll report, 2011)

Option 3 – Optimised geometry

Option 3 balances the simplified fabrication provided by option 1 with the improved architectural alignment and reduction in secondary steelwork realised by option 2.

To achieve this, the truss width is kept constant at 7.5 m along its length. Secondary steelwork is therefore reduced over option 1 and fabrication is simplified over option 2.

Tapering the truss along its length retains the structural efficiencies provided by option 2 whilst improving the alignment with architectural soffit over option 1.

Removing the faceted soffit across the width of the truss, has the significant benefit is simplifying fabrication, reducing piece count and overall tonnage. (Ramboll report 2011, pp. 547-549)

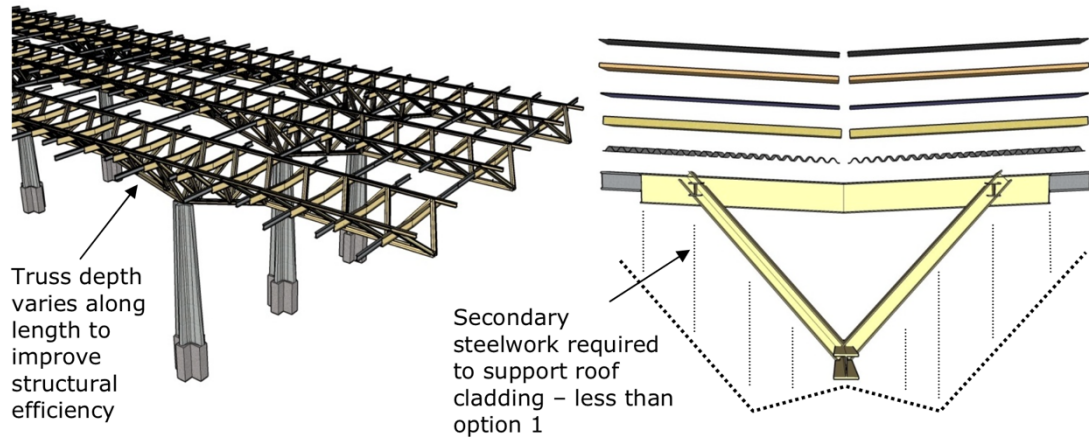

Figure 4.19 Isometric and section through trichord option 3 (Ramboll report, 2011)

4.3 'Star Truss' Design Philosophy

The reduction in principal from 74 m to 45 m reduced the aspect ratio of the column grid. This combined with the closed rather than continuous roof-lights implied that at a rectangular grillage arrangement may be a structural solution. Diagonally spanning primary structural elements would address the problem of providing connectivity between adjacent roof bays without running substantial structure across the roof-light openings. Longitudinal trusses would remain, and the resulting pattern formed in plan gave rise to the 'star truss' nomenclature.

4.3.1 'Star Truss' – Principal Structural Elements

Once the star truss arrangement was established a study was undertaken to establish the best solution for the principal structural elements. Based on work undertaken previously it was possible to narrow the choice down to tri-chord trusses and planar trusses with restraint elements. Structural analysis demonstrated that the performance of both solutions was comparable. However planar trusses offered potentially simpler fabrication and construction sequences and were therefore taken forward for development of the 'star truss' roof scheme.

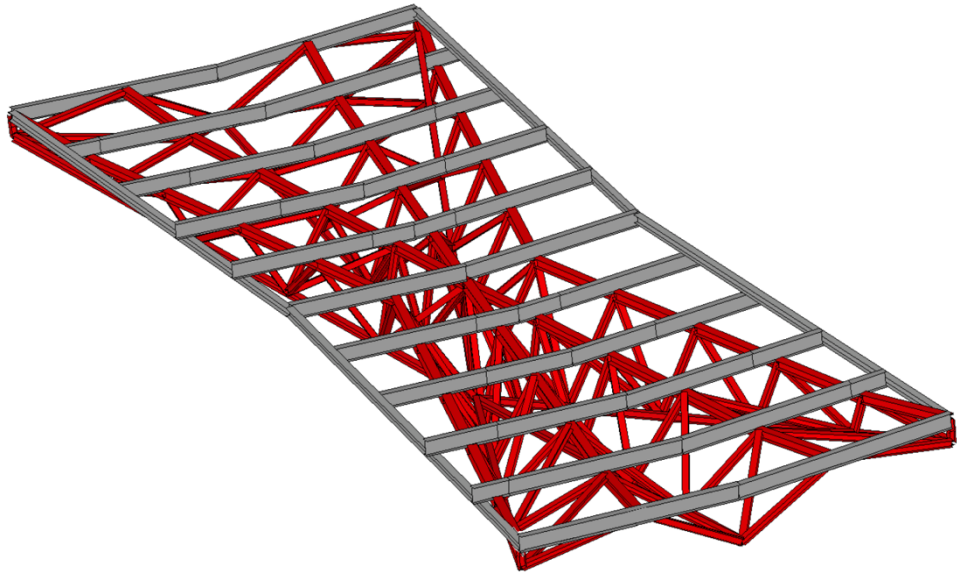

Figure 4.20 Alternative option evaluated as part of the design development process – star arrangement of tri-chord trusses (Ramboll report, 2011)

Vertical Load Path

Vertical loading is carried through bending of the rafters spanning onto the planar truss arrangement. In turn diagonal and longitudinal trusses span this load back to the support columns, as shown in Figure 4.20 below.

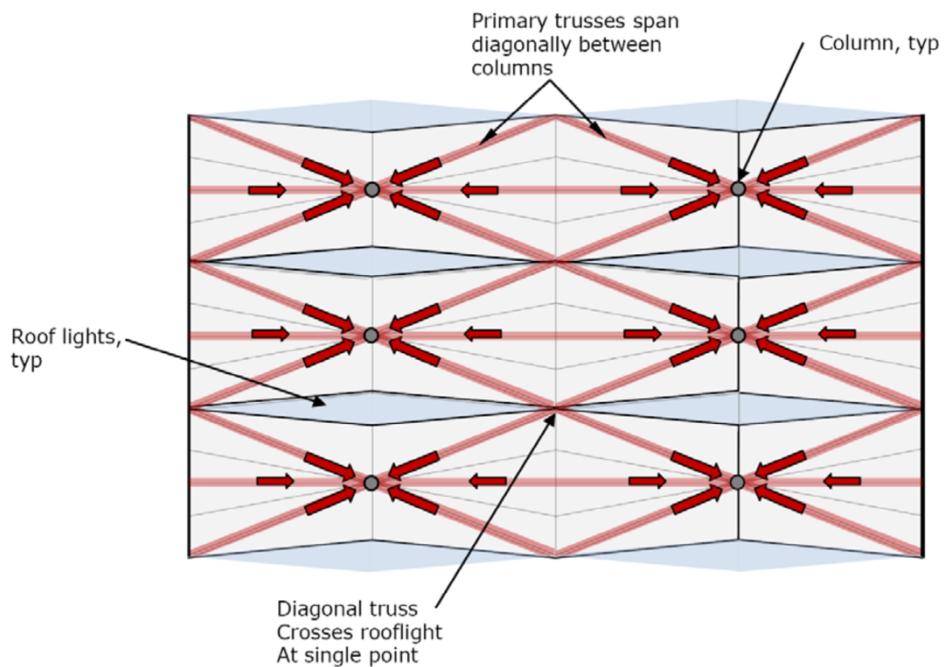

Figure 4.21 Star truss arrangement plan (Ramboll report, 2011)

Symmetric and asymmetric vertical loading is resisted by the major axis bending resistance of the diagonal trusses. Therefore vertical stiffness of the roof is a function of the major axis bending stiffness of the trusses.

Raking struts are provided to restrain the bottom chords of the truss against local buckling. These transfer forces into the rafter plane where the roof structure acts as a diaphragm to distribute the forces to the roof columns that provide stability. Truss top chords are restrained directly by the rafters.

Global buckling of the truss chords between stability columns is resisted by horizontal truss action of the roof structure.

Lateral loads are transmitted directly into the roof structure by wind pressure and drag acting on the roof, whilst wind posts transmit forces generated on the façade by the wind. Notional lateral loads are also generated by construction imperfections. These forces are transmitted to the lateral stability roof columns by diaphragm action of the roof.

Where thermal expansion is 'locked-in' by the stability system, lateral forces are generated. (Ramboll report 2011, pp. 572-573)

Having developed the 'star truss' scheme to the same level, it was possible to evaluate it against the linear tri-chord scheme. The star truss was demonstrated to be a better solution. This section summarises the key points.

Advantages

The 'star truss' scheme has been shown to offer the following advantages over the previous tri-chord scheme:

- Improved alignment with architectural intent: link beams across roof-light removed.
- Reduction in secondary steelwork: the star arrangement of planar trusses conforms more closely to the roof soffit geometry. Consequently, secondary steelwork required to hang the soffit is reduced.

- Reduction in overall cost: the improved vertical and lateral performance and reduction in secondary steelwork is likely to have a beneficial impact on the overall cost of the roof structure.
- Improved performance in resisting uniform vertical loading: the star arrangement performs better under uniform gravity loading combinations than the tri-chord arrangement. This is predominately due to increased utilisation of the available structural zone and the higher degree of structural redundancy.
- Improved global lateral stability: the star arrangement forms a plan bracing arrangement over the roof surface.

This mobilises the lateral stiffness of the roof elements compositely, resulting in an extremely high stiffness; it behaves as a rigid diaphragm. This is in contrast to the linear tri-chord truss system, where the lateral stiffness of individual roof bays acts in parallel, producing a far lower global stiffness. The effect of the rigid diaphragm is to distribute lateral loads between all stability elements, thereby reducing overall deflection. Also, the secondary warping component of displacement due to the bending of lateral wind trusses is considerably reduced. As the plan stiffness of the tri-chord is dependent on the horizontal bending stiffness of the truss the deflection is very sensitive to the spacing of the stability system. This is illustrated in Figure 4.21 and Figure 4.22.

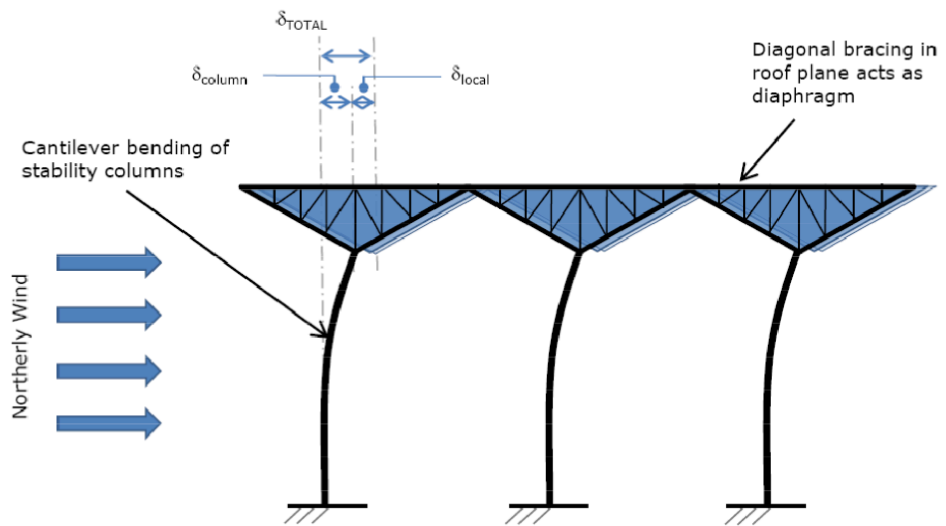
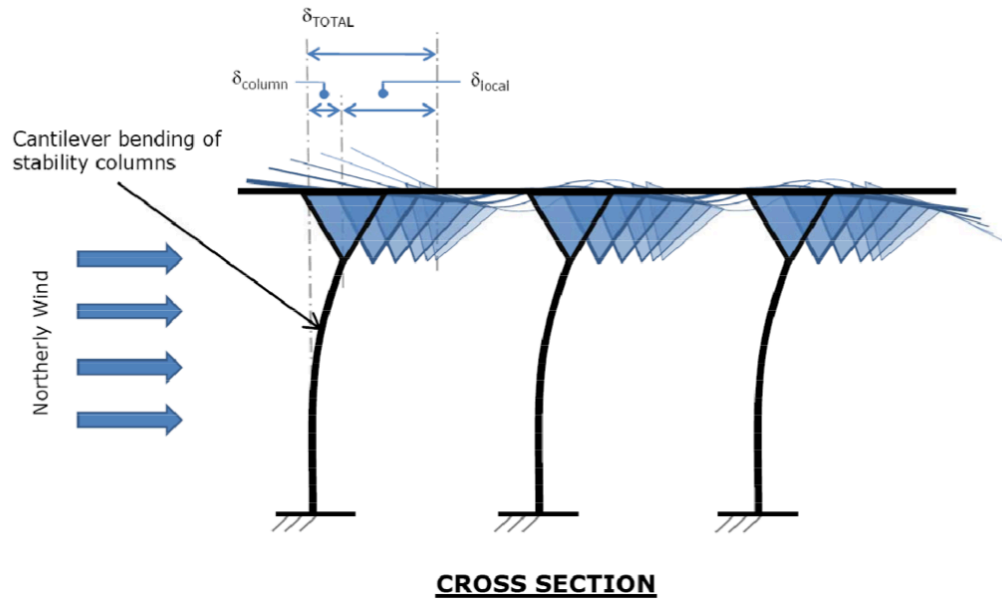

Figure 4.22 Deflection under lateral loads – comparison between tri-chord and 'star truss' structural systems. Cross sections. (Ramboll report 2011, p. 574)

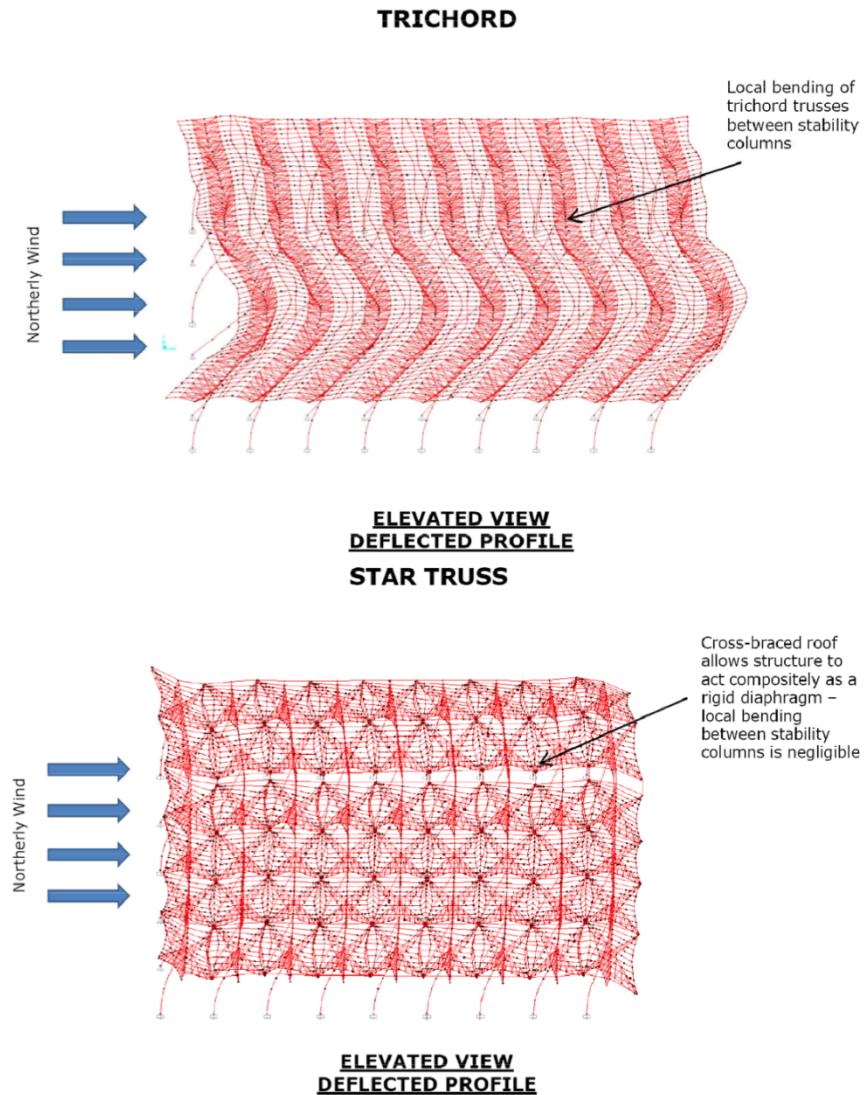

Figure 4.23 Figure 4.23 Deflection under lateral loads – comparison between tri-chord and ‘star truss’ structural systems. Plans. (Ramboll report 2011, p. 575)

Disadvantages

The star truss arrangement does present some disadvantages in comparison to the linear tri-chord scheme. Subsequent design development focused on mitigating these effects:

- Increased piece count of primary steel: the bottom chord of the planar trusses will require lateral restraint in the form of diagonal raking members connected to the roof rafters. This increases the overall piece count of primary structure. However, this is offset by a reduction in secondary

steelwork as the raker partially performs this function. The diagonal raker also reduces the span and therefore requires capacity of the rafter.

- Complicated connection at junction of trusses: the geometry at the cross-over points between the roof-lights leads to significant congestion at a highly stressed location. The introduction of a kinked geometry to alleviate the congestion was explored, but it had an unacceptable impact on the roof stiffness, without offering significant fabrication or architectural advantages. The solution is to use a fabricated steel section, the disadvantage of which is that it may attract additional fabrication costs due to its bespoke nature.
- Reduced performance in resisting asymmetric vertical loading: the diagonal planar trusses attract more load than the previously proposed link beams. Combined with a longer span (approximately 48.5 m on the diagonal) this results in an increased peak deflection at the point where the diagonal trusses converge at the roof-light ends. However, although the absolute value is greater, the permissible deflection is higher due to the longer span. Therefore whilst performance against this criteria is decreased the design is still within the defined limits.

It has two types of trusses bearing on 'mega columns' outline and columns inside. The structure is light and does not have many curves. All engineering networks are going through special openings in beams or through the space of truss. Service bridges are located underneath and fixed right to the truss structure.

Table 4.7 below summarises the results of the comparative study between the star arrangement of planar trusses and the linear tri-chord trusses connected by link beams. Based on these results the 'star truss' structural philosophy was taken forward for further development.

Table 4.7 Summary Table - Tri-chord vs. Star Truss (Ramboll report, p. 576)

Design Driver	Tri-chord	Star Truss	Comments
Primary steelwork tonnage	-	~5% reduction	Approx. 5% reduction in steelwork for star truss arrangement.
Piece count (Primary steelwork)	~3% less	-	No. of rakers required increases piece count for star truss option.
Piece count (secondary steelwork)	-	~50% less	
Overall Piece count		~20% less	Star truss provides an overall reduced piece count
No. Connections per bay (Including Secondary steelwork)		~30% less	
Deflection under uniform vertical loading	X	Y	For comparison 4 kN/m ² uniform loading applied. Star truss performs best.
Deflection under asymmetric vertical loading	-	-	For comparison 4 kN/m ² pattern loaded on 2 adjacent half bays in the longitudinal direction. Load path in the transverse direction increased; therefore a reduction in performance is experienced with the star truss.
Lateral deflection	-	~50% less	Total deflection under northerly wind, values include column bending deflection. Superior diaphragm action in star truss is clear from the comparison.
Soffit geometry	X	Y	The folds formed in the soffit geometry align with the profile of the star truss arrangement
Interface with roof-lights	X	Y	Star truss is superior, roof-lights interrupted by diagonal trusses every 45 m as opposed to extending every other rafter as a link beam with the tri-chord.
Maintenance	-	-	Catwalks run longitudinally, both schemes similar
Fabrication	-	-	Higher number of connections for star truss scheme but more standardised and straight-forward 2D geometry
Buildability	-	-	Lighter sections in the star truss but potentially more of them, both systems have reasonably complex/varying geometry

Having established an efficient, workable structural solution for the primary roof structure, subsequent development work was focused on refining the design and coordinating it with the architecture.

To facilitate rapid analysis of revised geometries and structural configurations a parametric model was constructed. This was used to form the basis for both computer analysis models and 3D CAD models. (Ramboll report 2011, p. 577)

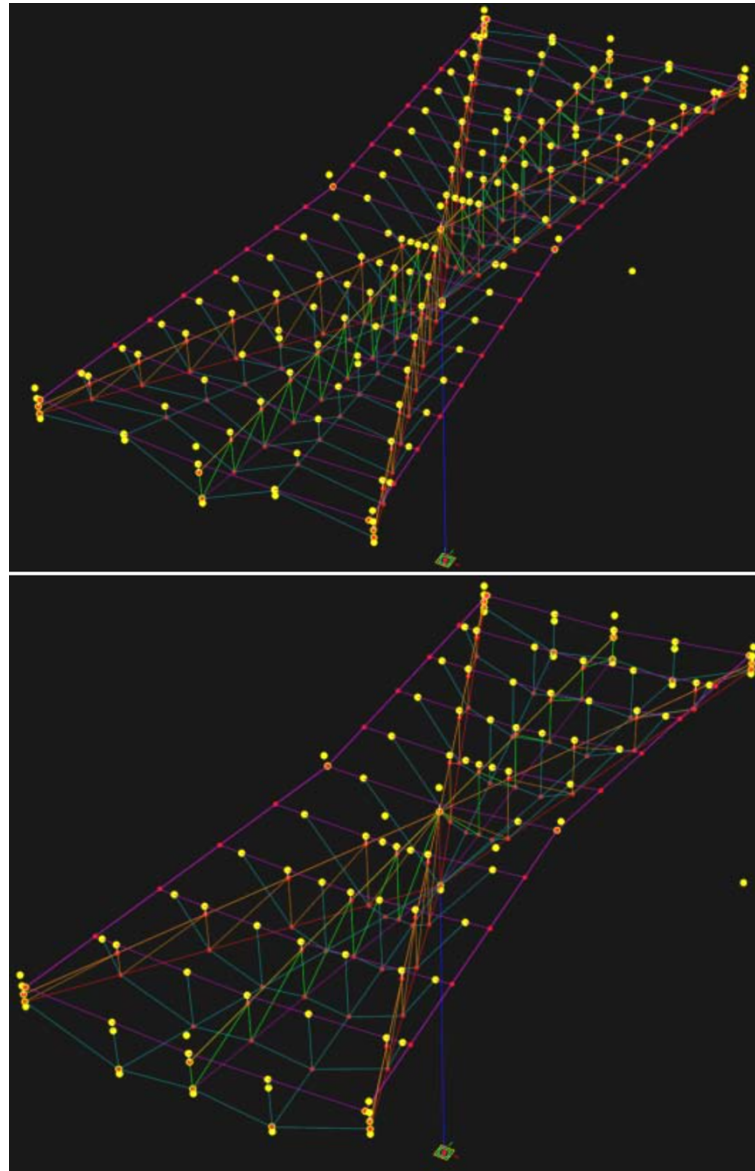

Figure 4.24 Parametric modelling of different structural arrangements for the 'star truss'. Increased number of truss nodes (top) and alternative soffit profile (bottom). (Ramboll report, 2011)

By doing this it was possible to explore multiple options, leading to a solution with the optimum balance of structural efficiency and aesthetic.

Establishing the stability column arrangement was crucial in defining how the roof would behave under wind, thermal and asymmetric gravity loads. Five options were compared, varying the layout and column fixity to find a balance between deflections and the stress locked into roof steelwork and supporting columns.

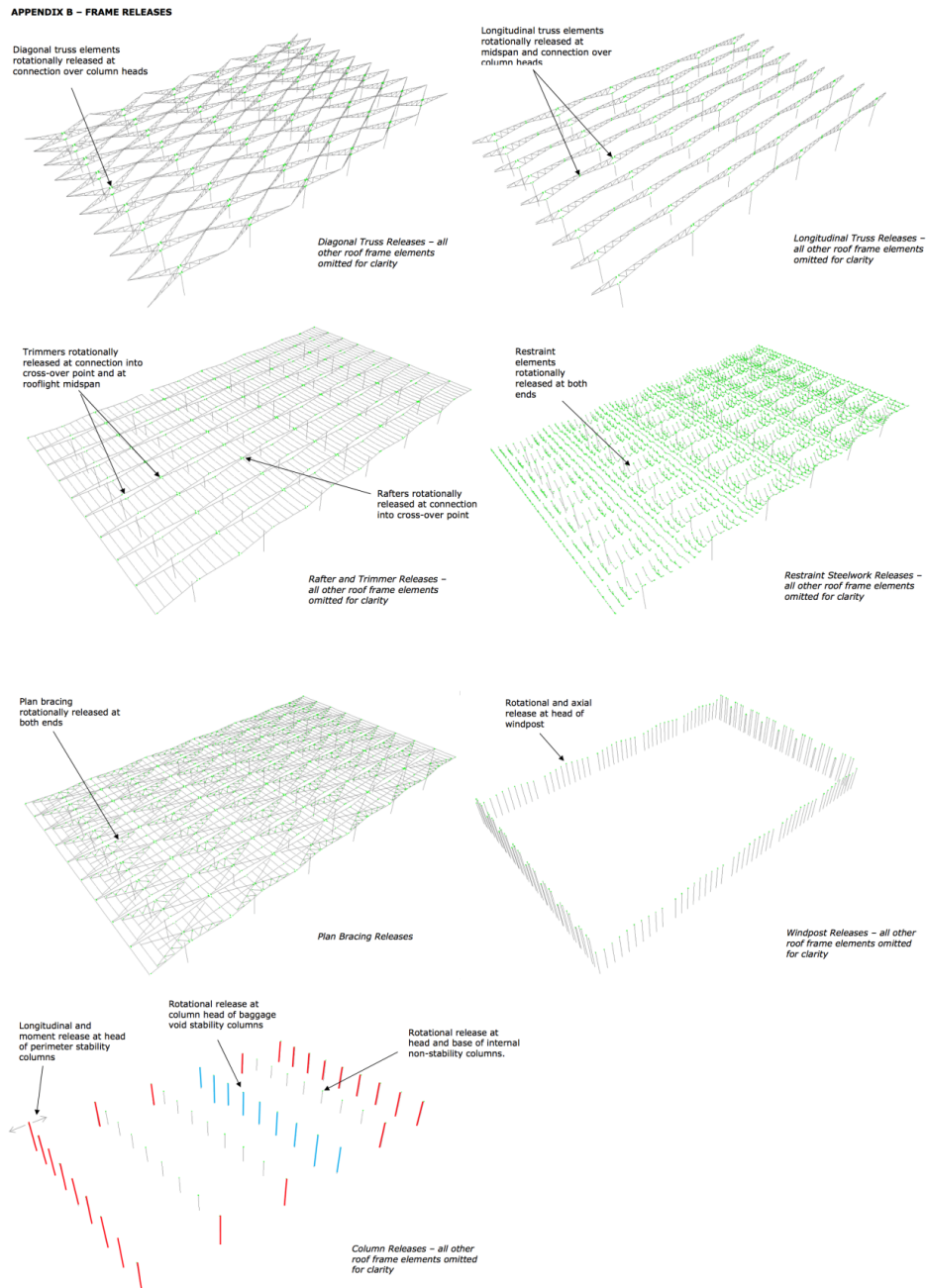

Figure 4.25 Frame releases (Ramboll report 2011, pp. 602-603)

Stability optimisation

Evaluation was based on:

- Vertical deflection of the roof structure: the asymmetric gravity load combination is the critical case for peak vertical deflections. Fixity of the columns will help to reduce this. As the design of the roof is governed by vertical stiffness this was considered a key driver in the comparison.
- Column base reactions: the stability columns layout governs the moment induced by internal forces, predominately from resisting thermal movement. The moments induced from resisting applied lateral loading such as wind are less dependent on the layout.
- They are simply proportional to the number of stability columns provided in the respective orientation if the load. The vertical reactions are relatively unaffected by the layout and fixity at the column head. The design of the stability columns themselves is governed by the required moment capacity and stiffness for each column. However, the architectural intent dictated visually massive columns at the perimeter and in the baggage reclaim void, regardless of the performance requirements of the chosen stability column arrangement. Spread of the columns from asymmetric loading will also induce a moment in the columns with base fixity; in this case the moment (arising from the lateral stiffness of the column) should be considered beneficial to the roof structure as whole as it helps to limit the vertical deflections, which is a key design driver.
- Bearing reactions: the lateral reactions at the bearing are governed by the same factors as the column base reactions. However they were not considered to be key driver, as the bearings need to a substantial size for the vertical reactions alone.
- Locked in thermal stress: the layout and fixity of the stability columns governs the locked in the stress in the roof steelwork. Allowing the roof to move will dissipate the thermal strains induced by changes in temperature, however restraining the roof steelwork to reduce these movements induces a locked in stress. When no movement joints are provided the stress induced is proportional to the length of steelwork between re-

strained points. The forces induced in the rafters were evaluated, with compression being the key driver. The rafters are significant as their main function is to carry vertical loading in bending about their major axis, subjecting them to substantial additional compression forces would result in an increased section size. The rafters are the most abundant element in the roof therefore an increase in section size would lead to a significant increase in steel tonnage.

The factors affecting the interface with adjoining Main Terminal structural elements have also been considered:

- Interface between facade and roof: with respect to the interface between the facade and roof, the optimum solution would be to connect them so that they experience the same movements. However in some cases this may simply cause excessive warping (stressing) of the glass, the solution being a relatively complex movement joint. Therefore each interface detail needs to be considered in terms of the best balance of differential movement and stress induced in the glass.
- Interface between internal column and roof: the lateral deflection at the internal column heads determines its inclination from vertical, this needs to be limited for aesthetic reasons and to prevent possible damage to adjoining internal finishes. The same factors affect deflection of the internal columns as the perimeter columns. An upper limit will be imposed on deflection to meet SNIPs requirements, but it is not considered a key driver for optimising the stability layout.
- Implication on internal reinforced concrete frame: the fixity at the interface between the internal columns and the reinforced concrete frame will have an impact on the reinforced concrete frame design. For all options there is a requirement to support the vertical load, but a moment connection would induce a base moment that would have to be resisted by the reinforced concrete frame.

Other considerations forming part of the evaluation:

- Number of bearings: the number of bearings has been included due to the cost impact. However due to their relatively low unit cost and the limited possible variation in number this is not regarded as a key criterium.
- Detailing: complexity of providing the required fixity / release at the bearing has been evaluated, as there are potential cost and buildability issues associated.

Each of the five stability options identified as being viable solutions were evaluated against the above criteria, with weighing applied depending on the importance. The resulting matrix formed the basis for the final stability system selection. (Ramboll report 2011, pp. 579-581)

Each of the options and the resulting matrix are described below.

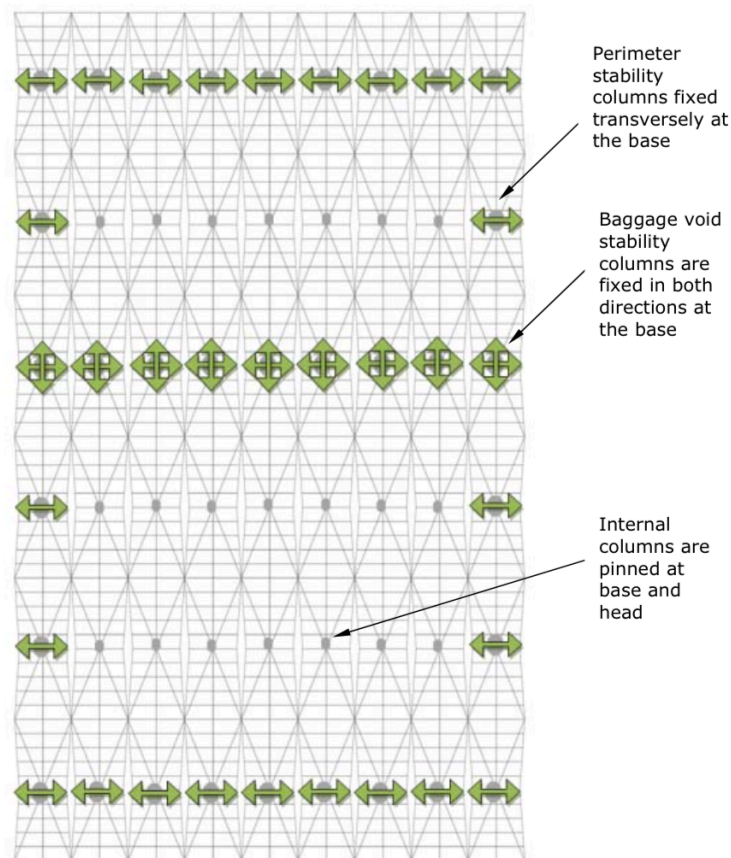

Figure 4.26 Option 1 - Stability Layout and Direction of Fixity (Ramboll report)

Option 1 contains no movement joint, and releases all columns in the longitudinal direction apart from the baggage void columns. This releases the locked in stress in the longitudinal direction, this has the greatest impact on the trusses

which predominately span in this direction. In the transverse direction all stability columns are fixed, this limits movement in this direction and helps to spread the lateral wind loading among a large number of columns, but induces a locked in thermal stress in the rafters.

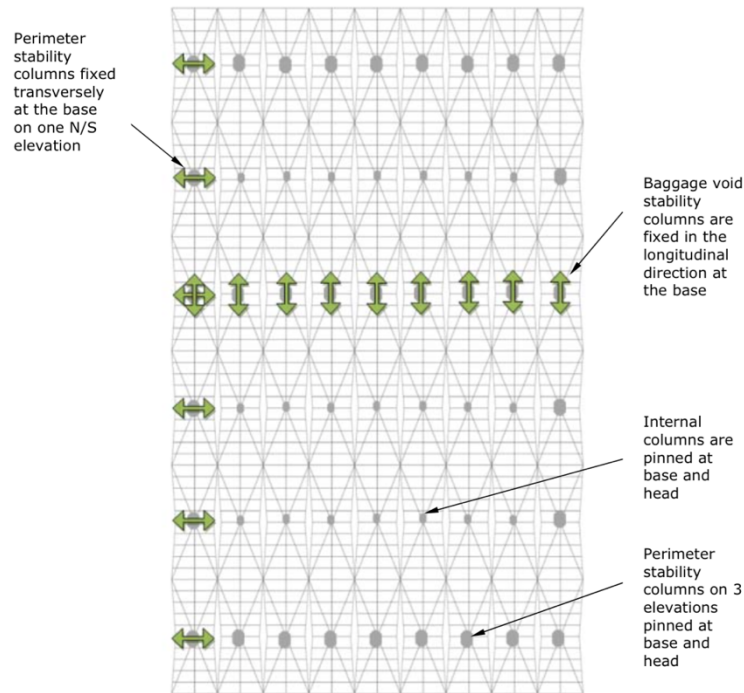

Figure 4.27 Option 2 - Stability Layout and Direction of Fixity (Ramboll report, 2011)

Option 2 is the stress optimal solution. It contains no movement joint but the arrangement of column fixity allows the roof to move unrestrained in both directions, therefore preventing any locked in stress in the columns and roof steelwork. This is achieved by providing only one line of fixity in each direction. The issue with this solution is that the columns providing stability in the transverse direction have to be located along one perimeter, this is the worst case scenario for producing transverse movements. The number of columns providing resistance to lateral loading in the transverse direction is also reduced, leading to increased lateral sway under wind loading.

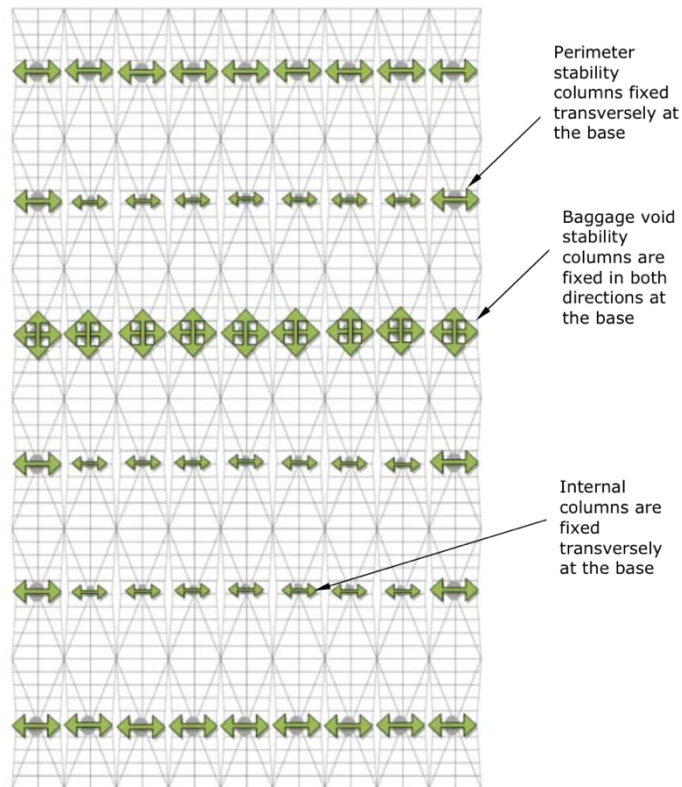

Figure 4.28 Option 3 - Stability Layout and Direction of Fixity (Ramboll report, 2011)

Option 3 is the movement optimal solution. It contains no movement joint, and releases all columns in the longitudinal direction apart from the baggage void columns. This releases the locked in stress in the longitudinal direction, this has the greatest impact on the trusses which predominately span in this direction. In the transverse direction all columns are fixed including the internal columns, this limits movement in this direction and helps to spread the lateral wind loading among a large number of columns, but induces a locked in thermal stress in the rafters. The benefit of this option over option 1 is that the fixity of the internal columns should reduce the vertical deflection from asymmetric gravity loading, and the relative stiffness of the internal columns means they should avoid attracting restraint loads from thermal stresses and lateral loadings. However it does make the roof system reliant on the reinforced concrete frame for lateral stiffness – adding design and construction complexity.

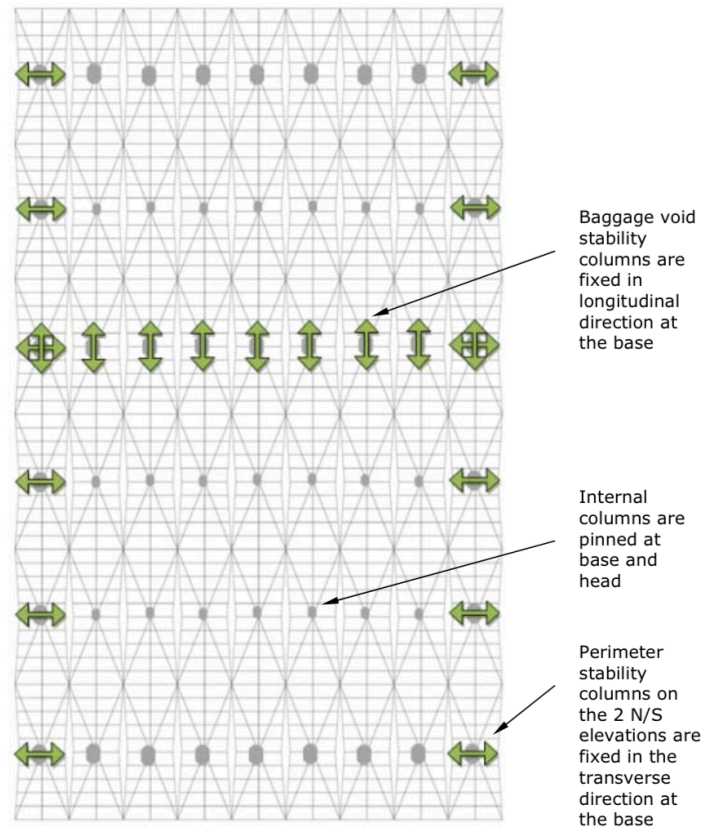

Figure 4.29 Option 4 - Stability Layout and Direction of Fixity (Ramboll report, 2011)

Option 4 is a hybrid solution looking to allow more transverse movement than options 1, 3, and 4 by releasing the perimeter columns on the East and West perimeters and the baggage columns in the transverse direction. This gives a comparison where the locked in stresses should be reduced as the 'pinch points' are removed from these lines of columns, but the reduced number of columns fixed in the transverse directions will increase their individual contribution to resisting lateral loadings. The vertical deflection from asymmetric gravity loadings will also increase as a consequence, which is undesirable.

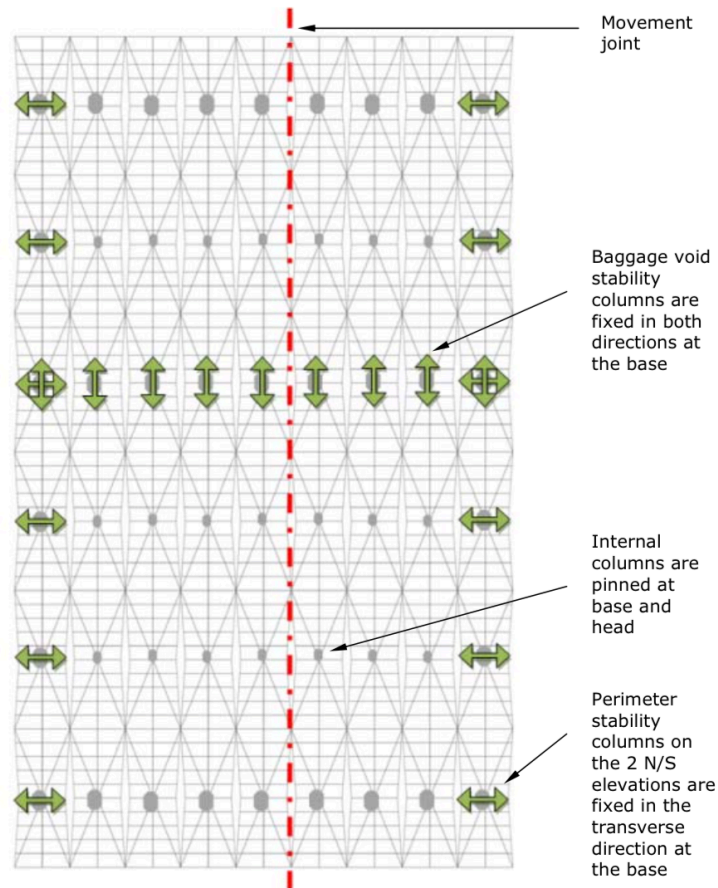

Figure 4.30 Option 5 - Stability Layout and Direction of Fixity (Ramboll report, 2011)

Option 5 is the same stability column layout as option 4 but incorporates a movement joint running along a central line of bays in the longitudinal direction. This is another stress optimal solution but compared to option 2 has a more favourable layout of columns fixed in the transverse directions in terms of transverse deflection, and sharing the lateral loading. The movement joint allows full movement of the rafters eliminating any locked in stress. A shortfall of this option is that the movement joint is an additional cost, and the lateral and vertical movements are likely to be significant.

4.4 Hazard philosophy

I. Hazard identification

The hazards were split into normal and abnormal groupings and key parameters for each hazard were also defined so that it is clear exactly what hazards have been assessed. These parameters may include for

example the magnitude, duration or frequency of the hazard. A qualitative assessment of the probability of each hazard occurring during the design life of the building was made and the hazards were split into the five groups given below:

- (1) Negligible – Probability rating - 0.01
- (2) Very unlikely – Probability rating - 0.1
- (3) Unlikely – Probability rating - 1
- (4) Possible – Probability rating - 10
- (5) Likely – Probability rating – 100

II. Assessment of consequences

At this stage in the process only a qualitative assessment of the consequence was made using the five levels of consequence suggested in BS EN1991-1-7:2006.

Severe - Sudden collapse of structure occurs with high potential for loss of life and injury. Consequence rating was taken 100.

High - Failure of part(s) of the structure with high potential for partial collapse and some potential for injury and disruption to users and public. Consequence rating was taken 10.

Medium - Failure of part of the structure. Total or partial collapse of structure is unlikely.

Small potential for injury and disruption to users and public. Consequence rating was taken 1.

Low - Local damage. Consequence rating was taken 0.1.

Very Low - Local damage of small importance. Consequence rating was taken 0.01.

III. Determination of risk

Number ratings are given to the consequence levels and probabilities of the hazards, these were multiplied together to give an indication of the risk. It should be noted that this is still essentially a qualitative rating; the numbers are simply an indication of the relative risks. Each of the possible permutations is given in Table 4.8 below. The shaded boxes indicate the risk level that appropriate mitigation measures will be deemed necessary.

Table 4.8 Risk rating (Ramboll report, 2011)

Severe (100)	1	10	100	1000	10000
High (10)	0.1	1	10	100	1000
Medium (1)	0.01	0.1	1	10	100
Low (0.1)	0.001	0.01	0.1	1	10
Very low (0.01)	0.0001	0.001	0.01	0.1	1
Consequence Probability	Negligible (0.01)	Very unlikely (0.1)	Unlikely (1)	Possible (10)	Likely (100)

The summary risks of the terminal's roof:

- The MTR has been assessed with respect to robustness against the most onerous design requirements of the Russian SNIPs, Russian guidance documents and Eurocodes.
- All roof support columns, both stability and non-stability, have been shown to withstand blast and impact loads, therefore satisfying the requirements of Eurocode key element design.
- To further safeguard against the risk of progressive collapse of adjacent roof bays, column removal analysis has also been carried out.
- Under all column removal cases considered, adjacent roof columns have been shown to support the additional roof loads redistributed as a consequence of the column removal.
- The impact of column removal on roof steel elements has also been assessed. This analysis confirmed that the removal of an internal column would not induce failure in any of the roof steel elements.
- Under conservative assumptions of linear material behaviour, the removal of perimeter stability columns has shown to result in roof steel failure within the bay of column removal and adjacent roof bays. The extent of

this failure is considered proportionate to the event inducing column failure.

- The removal of steel roof elements has also been considered. This is assumed to occur in isolation from the removal of support columns. Under the load combinations considered the analysis has confirmed that there is sufficient redundancy in the roof to ensure that removal of primary roof steel elements does not initiate failure in any other elements within the roof, further mitigating the risk progressive collapse.

4.5 Analyses of the UK frame system

4.5.1 Non-linear analysis

Each of the critical load combinations highlighted above have been run non-linearly to account for second-order effects on the stability columns.

The SAP2000 model ramps up the load and updates the stiffness matrix at each load step. Analysing the structure in the manner has ensured that eccentric moments are also applied to the stability columns as a result of roof bearing translation. (Ramboll report 2011, p. 632)

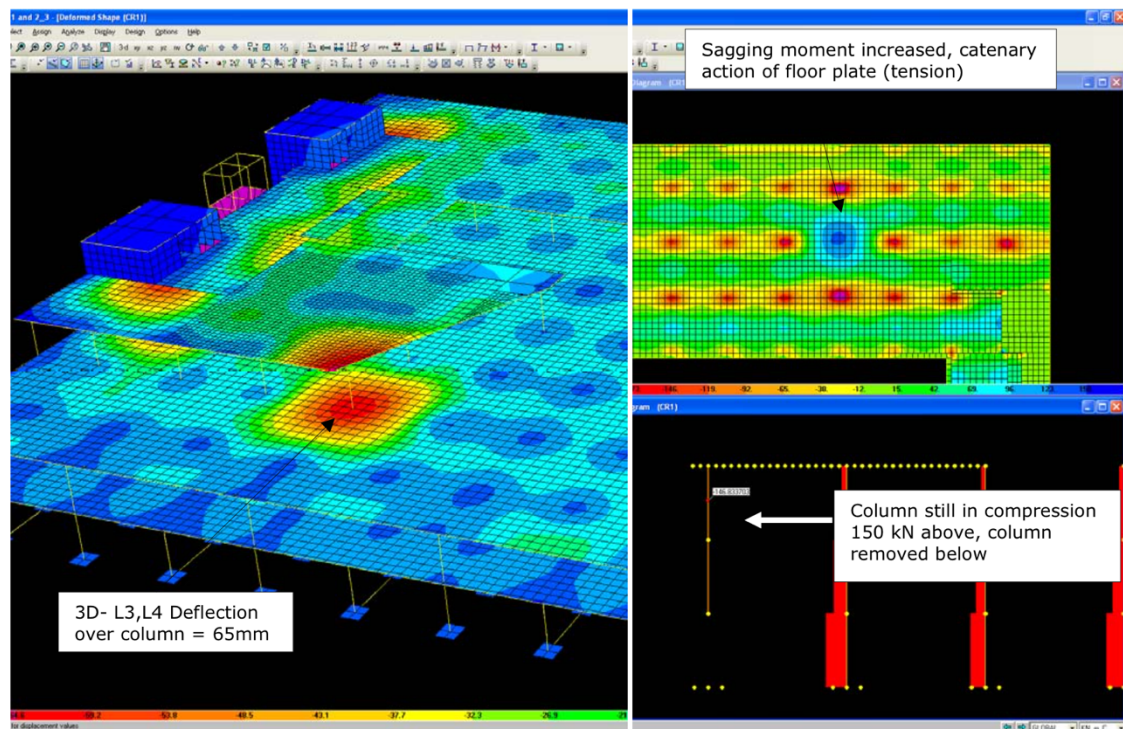

Figure 4.31 SAP Output – Moment Plots of L3, L4 slabs and column axial load

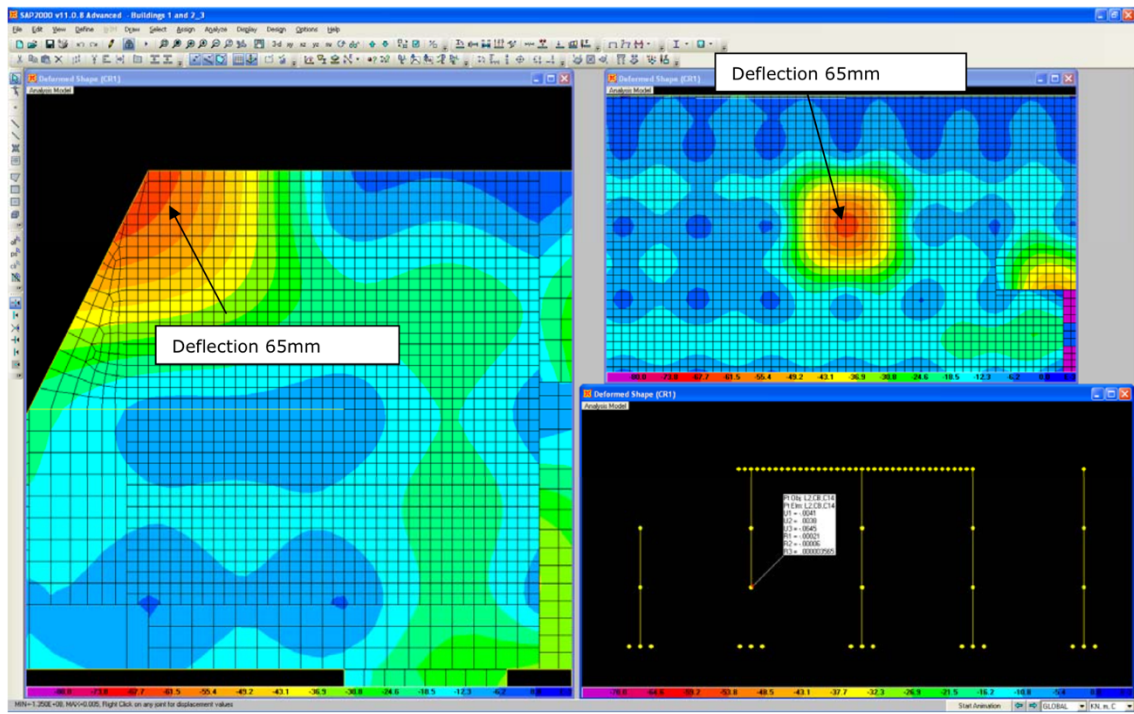

Figure 4.32 SAP Output – Deflection of 9 x 9 m Band Beam Slab with column removal (Ramboll report, 2011)

4.5.2 Buckling analysis

Restraint loads have been calculated in accordance with the relevant SNIP loads and applied to in the Finite Element analysis.

In addition to this, eigenvalue extraction buckling analysis has been carried out to determine the load factors at which buckling instability occurs.

The buckling model has the same geometry, support conditions and material and section properties as the base model outlined above. Each frame element has been divided into 10 discrete elements to capture all buckling mode shapes. This model has been used to verify restraint philosophy assumptions and determine the load factor at which buckling initiates.

As there is no formal robustness and disproportionate collapse guidance to SNIPS, the structural design approach will be in accordance with the following, refer to the detailed sections for specific design scenarios and considerations used for each structure. (Ramboll report 2011, p. 600)

4.5.3 Full compliance with Eurocodes

A risk assessment according to Eurocodes for the Passenger Terminal Facilities has been completed.

Key Element design to Eurocodes - with all key elements to pass when assessed with the prescribed impact loading, noting that Eurocodes are more onerous than the Saint Petersburg Territorial Standard Norm for key element design, walls – 34 kN / m² to one face, columns 150 kN applied one meter above floor level.

Column and Element Removal Analysis to MGSN (in addition to key element design to Eurocodes) for typical internal and edge columns of all structures, with the aim of verifying the following:

- Integrity of global building stability, to verify local element removal (elements supporting greater than 80 m² does not cause global failure) which would be a disproportionately large impact for a local event;
- Assessment of whether column removal does cause local collapse of the surrounding floor plate.

Special calculations were made in five different places of the terminal in case of column collapse. The drawing is presented in Appendix B.

Blast / Impact protection considerations – stand off distances, vehicular protection to columns provided by bollards where required.

Monolithic reinforced concrete floor structures

- Vertical and horizontal tie reinforcement to tie columns to floor plates;
- Floor slabs, beams, diaphragms and walls with additional reinforcement to allow for increased and reversing bending moments caused when a column / beam / wall is removed, with additional reinforcement to resist in-plane tension forces created when catenary action or alternative load paths are required to prevent the collapse of a floor plate;
- Overload capacity of load bearing elements such as beams / columns / slabs / walls;

- Fixity of reinforcement in floor slabs to provide continuity between elements;
- Multiple load paths.

Steel Structures

- Ductile connection design to support elements developing the full plastic capacity;
- Multiple load paths;
- Overload capacity of load bearing elements.

Both TSN and MGSN are written for high-rise public buildings, where the removal of a column could be more likely to induce a global structural failure (impacting building stability). (Ramboll report 2011, p. 630)

The Pulkovo Airport Terminal structures are all low rise, some with large grids 45 x 18 m steel roof, and 18 x 18 m and reinforced concrete floors and 18 x 18 m double level steel framed footbridges. Therefore the relevance of the above MGSN high-rise design code is limited. The design is complied with the intent of the Russian guidance for column removal and providing significant overload capacity for key elements to resist impact loading and bomb blasts.

4.6 Russian combinations of loads

Table 4.9 below presents the loads combinations that were used by Russian engineers.

Table 4.9 Loads combinations (Stalkonstruksia Ltd report)

Loads	Normal value, kg/m ²	Reliability factor	Design value, kg/m ²	Notice
Dead weight of metal structure	75	1.05	79	
Dead weight of roof coating and profile plate	65 + 14 = 79	1.3; 1.05	65 x 1.3 + 14 x 1.05 = 100	
Ceiling	23	1.2	28	
Technological	75	1.2	90	
Weight of bridging system	Due to bridges location			

Short-term	50	1.3	65	Without snow
Short-term on bridging system:				
- vertical	75	1.3	98	
- horizontal	30	1.3	39	
Snow (III district)	140	1.43	200	
Wind (II district):				
-approximately 10 min.	30	1.4	42	
-approximately 15 sec (for studwork calculation).	75	1.4	105	

In this calculation engineers also took into consideration the fact that snow can be distributed uneven near the roof-lights or on the half of a block span (Figure 4.33).

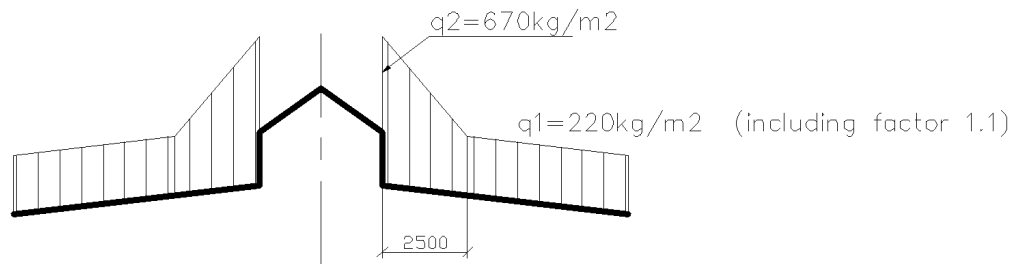

Figure 4.33 Uneven snow loads (Stalkonstruksia Ltd report)

Wind load was taken with dynamic parameters. The design value of a load is obtained by multiplying it by the safety factor of a structure 1.1 due to the function of a building. Additional calculation was made in case of one column destruction. Furthermore calculation involves temperature gradient of outdoor – 5° C (formula 13.10 SNIP 2.01.07-85*) and inside highest temperature + 27 ° C. (Stalkonstruksia Ltd report)

Below the structural scheme modelled in SCAD and loads combination is shown, Figures 4.34 – 4.40. The calculations presented below were executed by Stalkonstruksia Ltd.

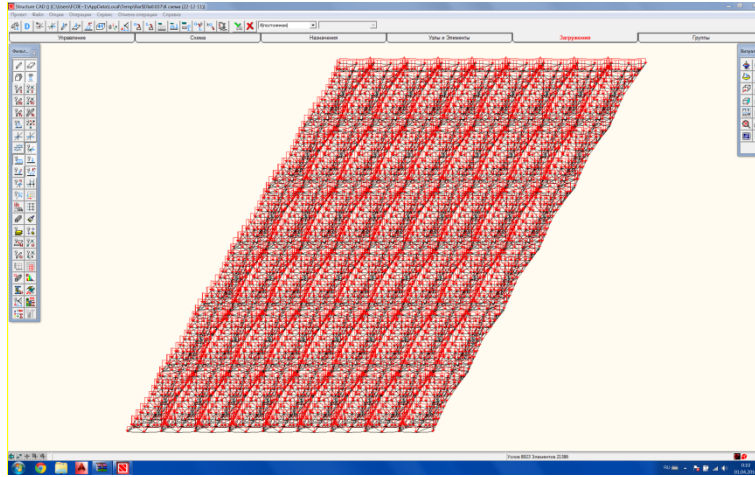

Figure 4.34 Permanent loads (SCAD model, Stalkonstruksia Ltd)

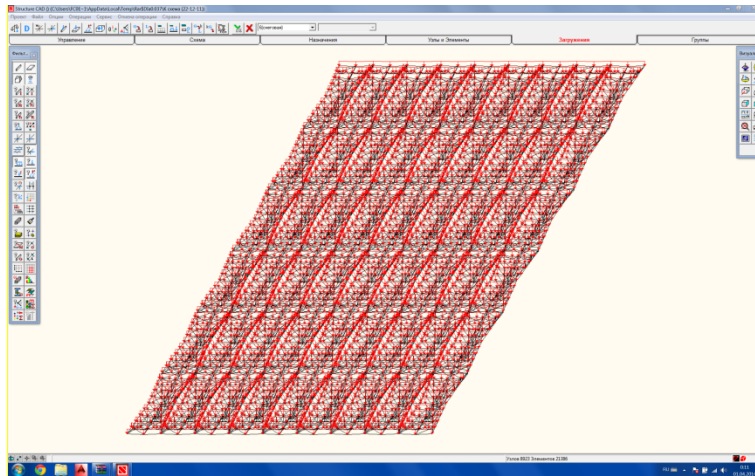

Figure 4.35 Snow loads (SCAD model, Stalkonstruksia Ltd)

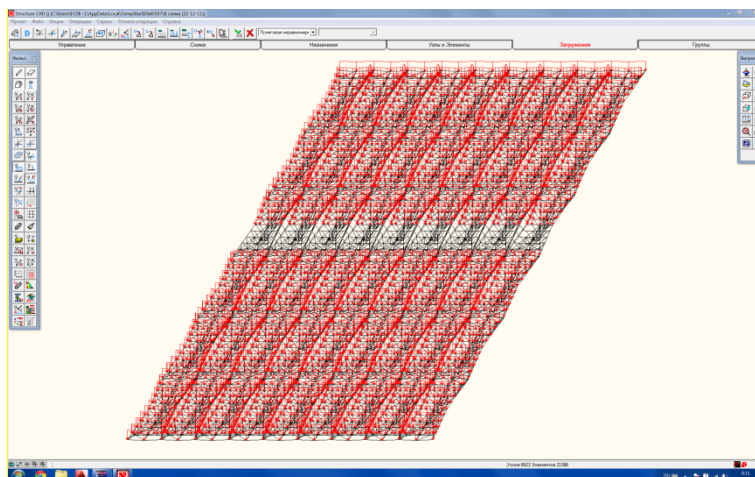

Figure 4.36 Snow loads uneven (SCAD model, Stalkonstruksia Ltd)

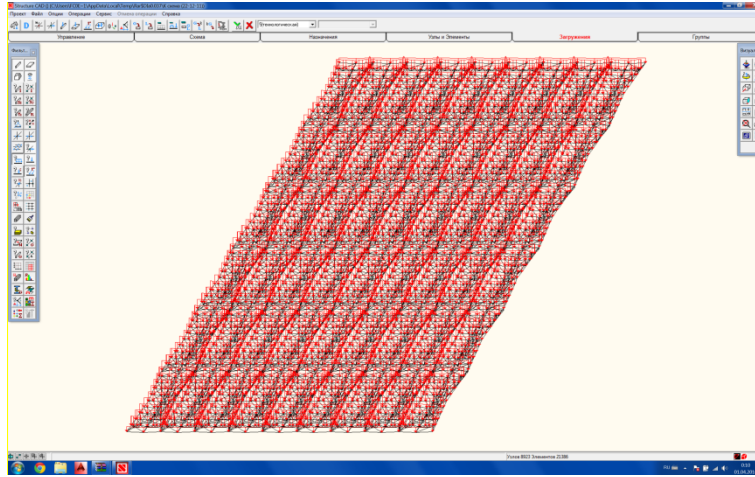

Figure 4.37 Technological loads (SCAD model, Stalkonstruksia Ltd)

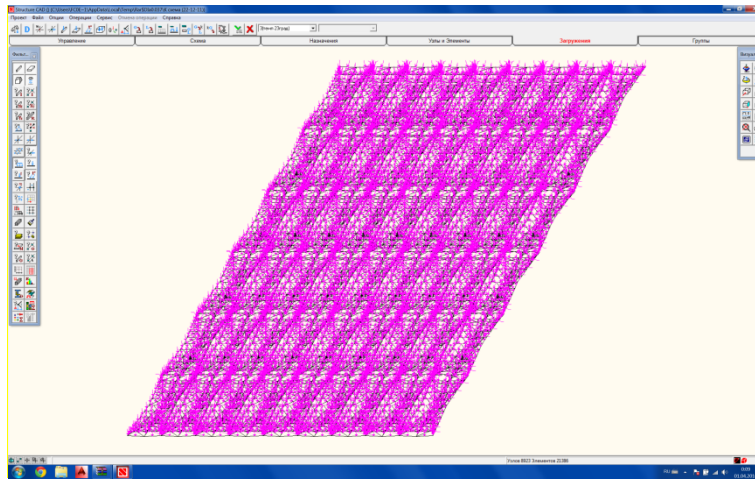

Figure 4.38 Temperature loads (SCAD model, Stalkonstruksia Ltd)

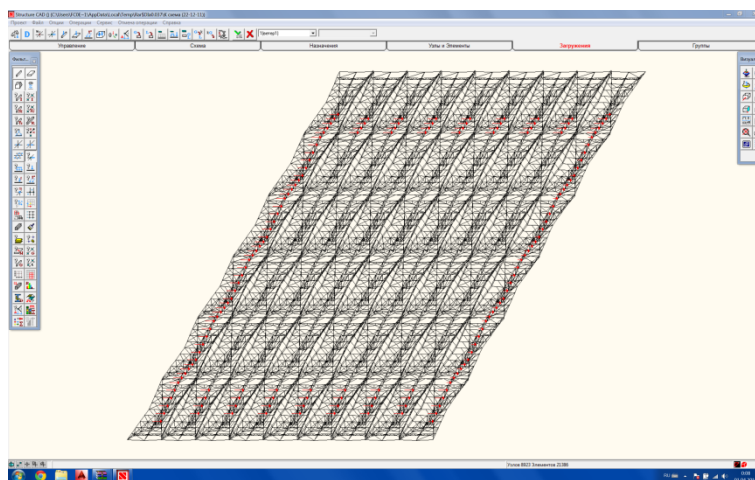

Figure 4.39 Wind loads (SCAD model, Stalkonstruksia Ltd)

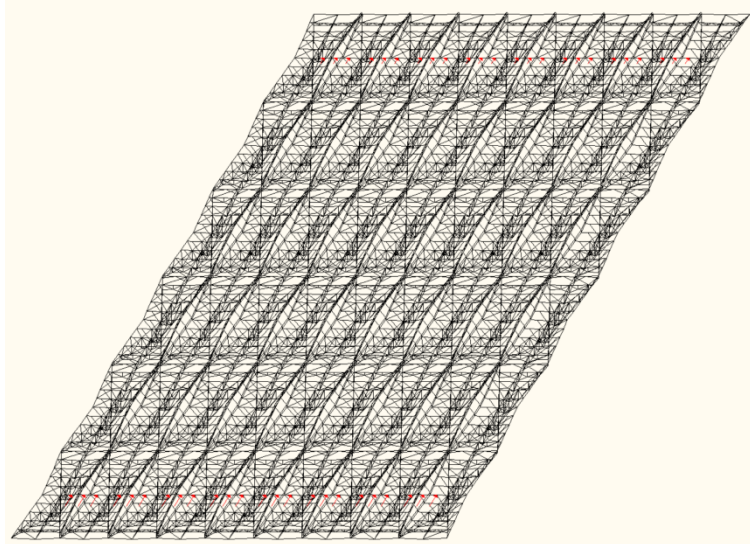

Figure 4.40 Wind loads on cantilever (SCAD model, Stalkonstruksia Ltd)

5 Roof Structure

5.1 The Final Roof Structure Designed by London Engineers

The roof structure is of steel construction and covers the main terminal building and the areas directly in front of the east and west facades. The roof is approximately 270 m by 162 m on plan, equating to an area of 43 740 m².

The roof structure is arranged on an 18 m x 45 m orthogonal roof column grid. The principal structural elements are steel planar trusses spanning 48 m diagonally between the roof columns. In addition to these, planar trusses also span 45 m longitudinally between the columns. Orthogonal rafters span over the trusses and cantilever to pick up the edges of the roof-lights or form the roof perimeter. This 'star' arrangement of trusses creates space for longitudinal roof-lights whilst creating a stiff structure, which acts as a grillage to resist vertical loads and a diaphragm to distribute lateral loads between the stability elements.

Octagonal reinforced concrete columns provide vertical support. Around the terminal perimeter and across the baggage reclaim void these are very large stability 'mega columns' which taper from their base at ground level to their head beneath the roof soffit. The remaining 'internal columns' rise from Level 3 to the roof soffit and resist vertical loads only so they are correspondingly smaller, but still tapered.

Internally the roof architecture comprises of 9 discrete bays, each 18 m wide and separated by a series of roof-lights. Each bay is approximately 270 m long and split into 6 discrete geometric units each 45 m long, see Figure 5.1.

Externally each 18 m x 45 m unit is split into 2 planes that fall (5°) towards a central gutter to allow drainage and avoid excessive rainwater accumulation at any one specific point. The width of the unit varies along its length. The minimum width is 12 m over supports, where the roof-lights are at their widest. These increase up to a maximum of 18 m at the unit's mid-span, where the diagonal trusses cross at the ends of the roof-lights.

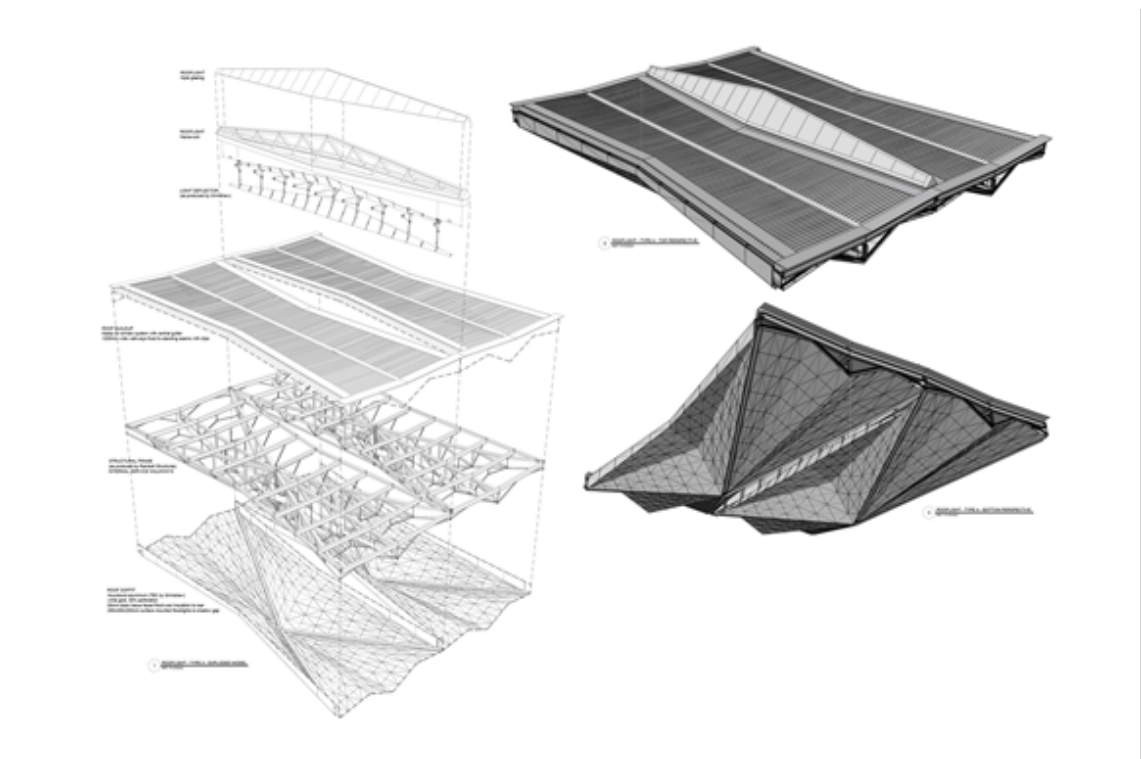

Figure 5.1 Discrete geometric unit of the roof (Ramboll report, 2011)

Configuration of supporting steel structure is caused by the unusual form of coating ceilings and roof-lights in all spans. Due to its inherent vertical and torsional stiffness and alignment with the roof soffit geometry, the solution was planar trusses spanning longitudinally and diagonally between the roof columns. Planar trusses combine strength and stiffness with economy of materials and are therefore an efficient structural system for long spans (Figure 5.2).

The longitudinal trusses span a total distance of 270 m, comprised of 5 internal spans of 45 m with 2 cantilevers at the east and west facades of 22.5 m. The truss is continuous over the roof columns. Each 45 m span of the truss is broken down into 10 bays of 4.5 m – this matches the facade and roof-light glazing module of 2.25 m. The diagonal trusses follow the same logic, but due to their angle they span 48.5 m and division into 10 bays yields segments, which are 4.85 m long. Each planar truss varies in depth along its length to maximize efficiency whilst matching the roof soffit profile. Over supports where bending moments are largest the truss is 6.5 m deep, at mid-span, where bending moments are reduced due to the multi-span nature of the structure, the depth decreases to 1.5 m (longitudinal trusses) and 0.9 m (diagonal trusses).

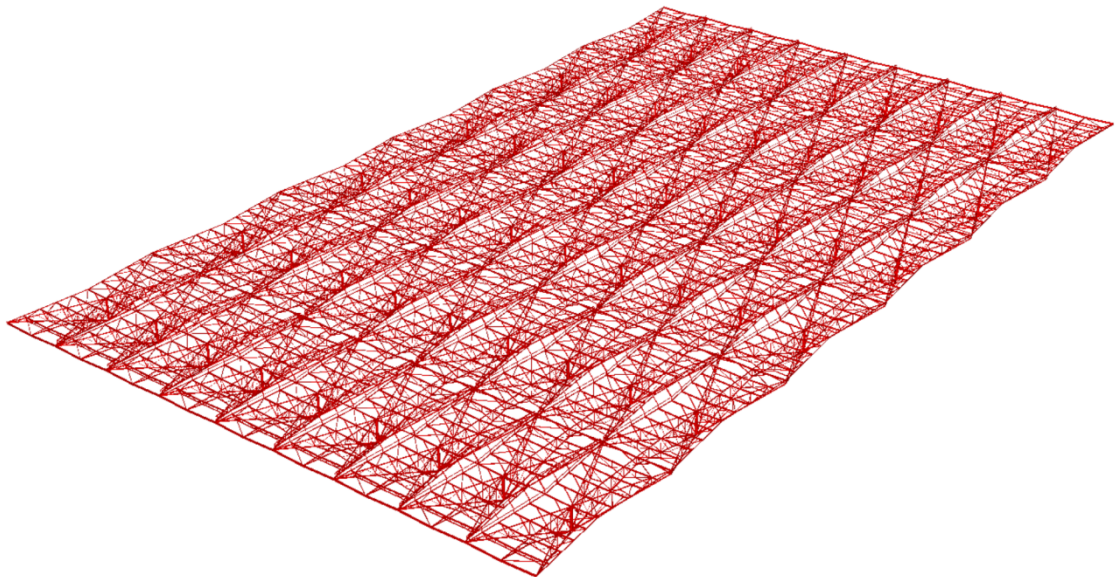

Figure 5.2 Structural scheme of the roof (SCAD model, Stalkonstruksia Ltd)

Diagonal bracing in the planar trusses provides coincident node points top and bottom for the restraint members and rafters. This arrangement also has a small structural benefit in that it shortens the length of the diagonals carrying the greatest compressive forces.

Roof load is transferred into the trusses by lightweight metal deck spanning 4.5 m (continuously over two or more spans) onto rafters, which run continuously over the top of the trusses. These also serve the purpose of restraining the top chords of the trusses, thereby reducing their effective length with respect to buckling and minimizing section sizes. The bottom chords of the trusses are

restrained using struts connected to the rafters. These restraint members serve two other purposes; they prop the rafters reducing their span with respect to vertical loads and they conform to the architectural soffit, providing direct support to the finishes. Restraint forces transferred into the plane of the rafters are transmitted into the global stability system by means of plan bracing. The rooflights are supported on the tips of the rafter cantilevers, with an edge trimmer to partially distribute the load and unify deflections. These trimmers also form part of the global restraint system, providing a load path for restraint forces between the truss compression chords and the stability columns.

The roof is supported by reinforced concrete columns located on a 45 m x 18 m grid. All roof columns are octagonal in section and taper from their base to head. They split into two main types: 'stability' and 'internal' columns as shown in Figure 5.3.

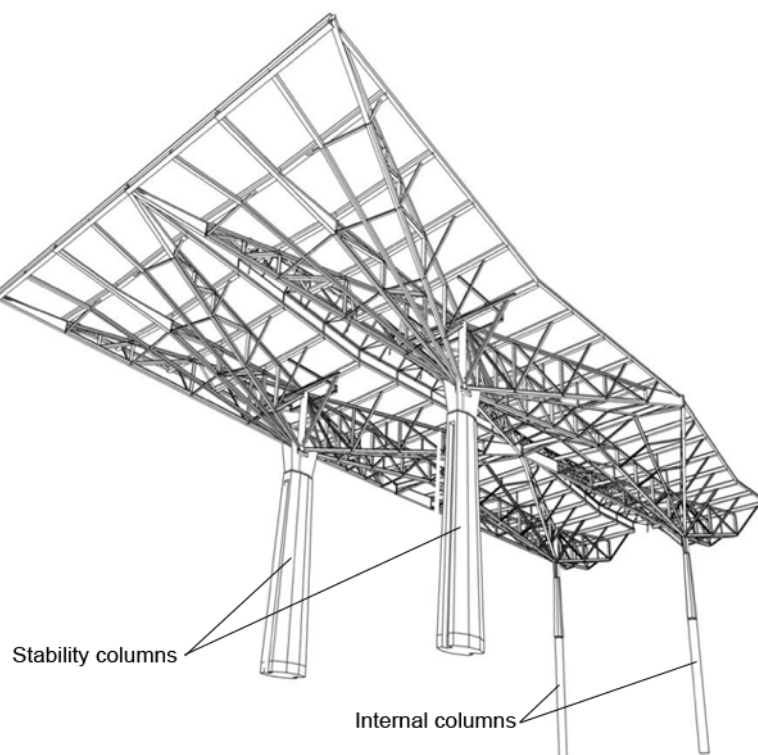

Figure 5.3 'Stability' and 'internal' columns (Ramboll report, 2011)

The stability columns are located around the building perimeter and across the baggage void. They are designed as vertical cantilevers and transfer vertical loads from the roof and horizontal loads from the roof and facade to the founda-

tions. Pinned connections at the head prevent roof-bending moments being transferred into the columns.

The internal columns spring from Level 3 of the internal frame and are designed to sustain only vertical load from the roof. To allow relative movement of the roof without bending moments being transferred, a pin bearing is located at each end of the column. Therefore, as the roof moves laterally or longitudinally, the column is free to rotate. The resultant horizontal component of the base reaction is resisted by the internal frame.

The roof-light structure (Figure 5.4) is designed to support its own self-weight and the dead and imposed loads from the glazing. By remaining independent from the primary roof structure it is unable to contribute to the overall system stiffness. The benefit is that undesirable global movements and stresses are not transferred into the glazing.

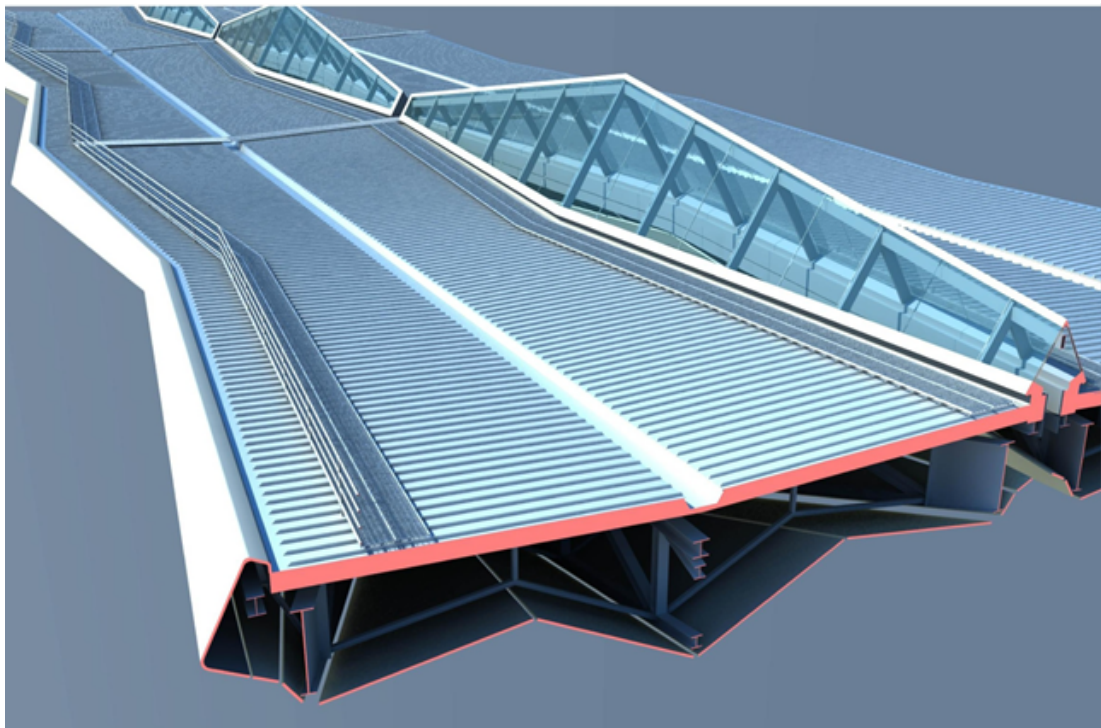

Figure 5.4 Roof-light structure (Ramboll report, 2011)

Access within the roof void is provided by an open grated walkway (Figure 5.5). This allows access along the length of each roof void (refer to architects drawings for details of the grating). The North and South roof modules have a differ-

ent arrangement to the central roof voids due to the altered soffit shape in these modules.

The access walkway is formed from an open grating spanning 1.2 m between longitudinal steel sections which span onto transverse steel sections supported by the roof primary steelwork. This walkway provides access to the roof soffit and the services located within the void. (Ramboll report 2011, pp. 31-55)

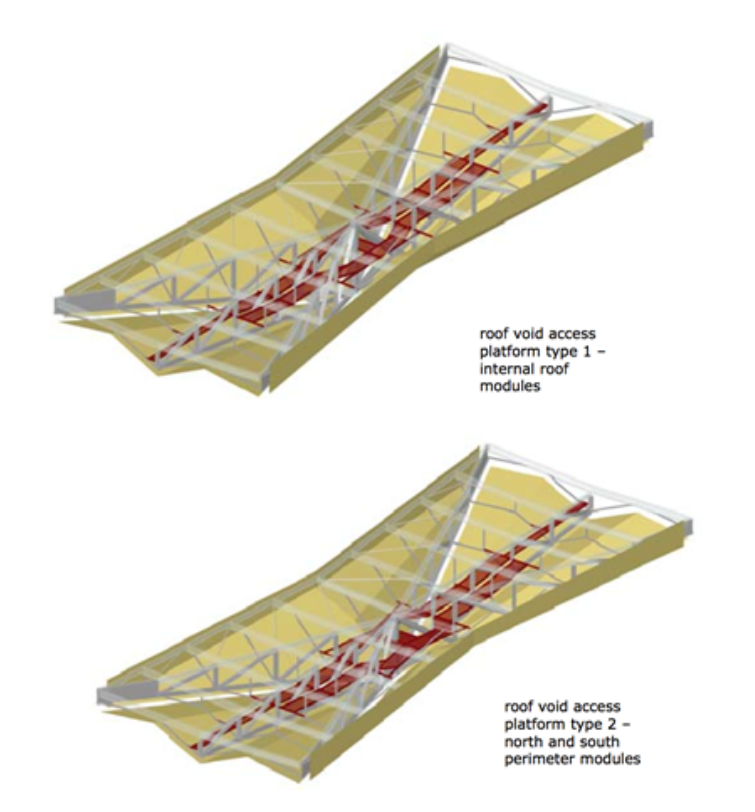

Figure 5.5 Roof walkways (Ramboll report, 2011)

5.2 The Final Roof Structure Designed by Saint Petersburg Engineers

The real model (Russian) is mainly based on the English design and research shown beyond.

Trusses are designed 5 - 6 m high on the support. Trusses strictly rely on the main (stability) columns and longitudinally on columns of smaller size (internal). If a truss bears on outline main columns then coating has the possibility of horizontal movements in case of temperature deformations, and rotation of all pedestals. For this purpose, all the support units are specially designed spherical to

allow free horizontal movement relative to the axes of columns 1, 26, 21-A, 16-A, 6-A and Y-21, Y-16, Y-6. All spherical supports allow rotation of pedestals in all directions. The roof plan is presented in Appendix C.

Buckling resistance is provided by the system of vertical and horizontal linkages in each bay (18 x 45 m).

Trusses are made from steel rectangular pipes. Most of the trusses, due to their oversize are connected to their belts by high-strength bolt connections with shearing resistance. There are special bearing structures for trusses on each of the columns that transmit all loads to the column. Moreover there is a bridging system located inside the web spaces that is used for maintenance.

After the designing process and calculation Russian engineers get the results that are explained below.

The material of a construction is a low-alloy steel 10XCHД-4, C345 and carbon steel C255, C245, C235, Cт20. Information according to steel codes is presented in Appendix D.

All connections were designed by welding or bolting with high-quality bolts and bolts of B class. In this project high-quality bolts are used for two types of junctions:

- (1) Share resistant fastening braces to chord and field joints truss chords
- (2) Connection working on the strength of bond cut in trusses

High-quality bolts M24 of class 10.9 due to GOST 52643-2006...52646-2006 from steel 40X with narrow limits of carbon parts – from 0,37% to 0,42% due to GOST 4543-71* with smallest time resistance 110 kg / mm², cold, location category 1.

The amount of steel for frame with bridging system and roof-lights is 3 550 t.

The amount of steel for studwork is 1 550 t.

The total amount of steel is 5 100 t. (Stalkonstruksia Ltd report)

6 Summary

The aim of this study was to investigate the approaches of two countries, the United Kingdom and Russian Federation, in the issue of architectural and structural design of the roof superstructure.

The thesis includes materials of design process, calculation and drawings of the terminals hall structure from both English and Russian side.

This work has been developed on the basis of relevant information by using the competent sources and internal design documents.

The project shows that the Eurocode system and the Russian National Code system requirements for superstructure design are almost the same excluding robustness and disproportionate collapse. On the other hand snow and wind loads in Eurocode are much higher than in SNIP (Russian National Code system) and this fact explains differences in design results. In addition, safety factors in Eurocodes are also higher; some of them are significantly greater.

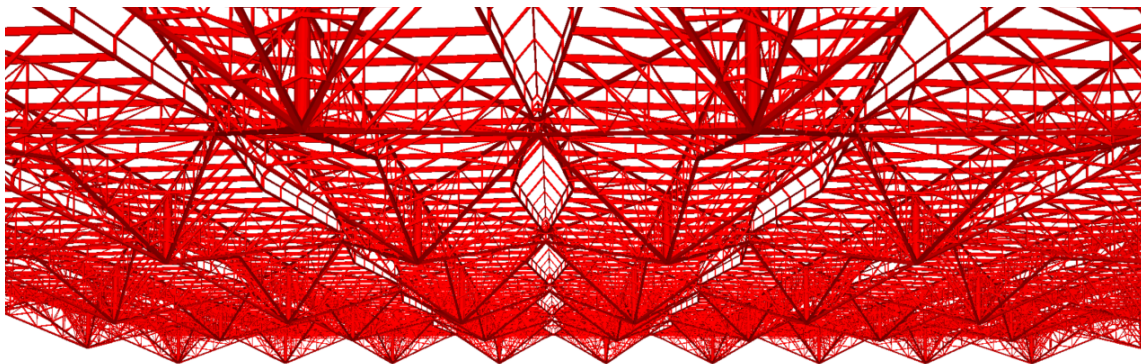

Figure 6.1 3D visualization of roof structure modelled in SCAD (Stalkonstruksia Ltd)

The project includes the analysis of used software and design results: structural schemes and steel codes.

According to the research the difference between two structural schemes is about 60% taking into account the same architectural design. In the comparison Table 6.1 below the main structural characteristics are shown:

Table 6.1 Summary table of roof structural designs

	Russian Federation	United Kingdom
Design software	SCAD Office	SAP 2000 and Lira Soft
Amount of steel in roof superstructure	Amount of steel for frame with bridging system and roof-lights is 3 550 t. Amount of steel for studwork is 1 550 t. Total amount of steel is 5 100 t.	No available information
Steel Grade (according Russian Codes)	Low-alloy steel 10XCHД-4, C345 and carbonaceous steel C255, C245, C235, CT20.	C345
Junction types	High-firm bolts M24 (steel)	High-firm bolts

The project of the Pulkovo Airport Terminal hall superstructure is a good example of executed modern state of the art construction developed by an international team of architects and designers to accommodate the extremes of climate experienced by the city, including the characteristically heavy snowfalls of the winter.

FIGURES

- Figure 1.1** Internal architecture of the roofing (Grimshaw Architects website), p. 4
- Figure 2.1** Structures inside St. Basil's Cathedral in Moscow (Wikipedia website), p. 6
- Figure 2.2** Interior of the Kazan Cathedral in Saint Petersburg (Wikipedia website), p.6
- Figure 2.3** First cast iron bridge in Saint Petersburg (Wikipedia website), p. 7
- Figure 2.4** Structural section of the St. Isaac's Cathedral (Wikipedia website), p. 7
- Figure 2.5** Steel (Apple Inc. website), p.8
- Figure 2.6** Frame-arch structure of Kievskii railway station in Moscow (Wikipedia website), p. 9
- Figure 4.1** Architectural plan of the roof, p. 21
- Figure 4.2** Roof access system, p. 22
- Figure 4.3** Roof-light section, p. 22
- Figure 4.4** Development of columns head, p. 23
- Figure 4.5** Terminal model in the wind tunnel, p. 23
- Figure 4.6** Snow patterns resulting from access, p. 24
- Figure 4.7** Snow patterns resulting from gutter maintenance, p. 24
- Figure 4.8** Truss and column sketches, p. 27-28
- Figure 4.9** Concrete box girder roof structure, p. 29
- Figure 4.10** Steel box girder roof structure, p. 30
- Figure 4.11** Isometric views of steel plate girder roof structure option, p. 31
- Figure 4.12** Steel plate girder roof structure option, p. 31
- Figure 4.13** Isometric views of planar truss roof structure option, p. 32
- Figure 4.14** Section through planar truss, p. 33
- Figure 4.15** Trichord truss roof structure option, p. 34
- Figure 4.16** Trichord truss section, p. 34
- Figure 4.17** Isometric and section through trichord option 1, p. 35
- Figure 4.18** Section through trichord, p. 36
- Figure 4.19** Isometric and section through trichord option 3, p. 37
- Figure 4.20** Alternative option evaluated as part of the design development process – star arrangement of tri-chord trusses, p. 38
- Figure 4.21** Star truss arrangement plan, p. 38
- Figure 4.22** Deflection under lateral loads – comparison between tri-chord and 'star truss' structural systems. Cross sections, p. 41
- Figure 4.23** Deflection under lateral loads – comparison between tri-chord and 'star truss' structural systems. Plans, p. 42
- Figure 4.24** Parametric modelling of different structural arrangements for the 'star truss'. Increased number of truss nodes (top) and alternative soffit profile (bottom), p. 45
- Figure 4.25** Frame releases, p. 46
- Figure 4.26** Option 1 - Stability Layout and Direction of Fixity, p. 49
- Figure 4.27** Option 2 - Stability Layout and Direction of Fixity, p. 50
- Figure 4.28** Option 3 - Stability Layout and Direction of Fixity, p. 51
- Figure 4.29** Option 4 - Stability Layout and Direction of Fixity, p. 52
- Figure 4.30** Option 5 - Stability Layout and Direction of Fixity, p. 53

Figure 4.31 SAP Output – Moment Plots of L3,L4 slabs and column axial load, p. 56
Figure 4.32 SAP Output – Deflection of 9x9m Band Beam Slab with column removal, p. 57
Figure 4.33 Uneven snow loads, p. 60
Figure 4.34 Permanent loads, p. 61
Figure 4.35 Snow loads, p. 61
Figure 4.36 Snow loads uneven, p. 61
Figure 4.37 Technological loads, p. 62
Figure 4.38 Temperature loads, p. 62
Figure 4.39 Wind loads, p. 62
Figure 4.40 Wind loads on cantilever, p. 63
Figure 5.1 Discrete geometric unite of the roof, p. 64
Figure 5.2 Structural scheme of the roof, p. 65
Figure 5.3 ‘Stability’ and ‘internal’ columns, p. 66
Figure 5.4 Roof-light structure, p. 67
Figure 5.5 Roof walkways, p. 68
Figure 6.1 3D visualization of roof structure modelled in SCAD, p. 70

CHARTS

Chart 3.1 Accident strategies, p. 16
Chart 3.2 Risks steps, p. 17

TABLES

Table 3.1 Eurocode system, p. 15
Table 3.2 Russian Technical Standards, p. 21
Table 4.1 Gravity loads, p. 25
Table 4.2 Lateral loads, p. 26
Table 4.3 Thermal loads, p. 26
Table 4.4 Resistant loads, p. 26
Table 4.5 Imposed load patterns, p. 26
Table 4.6 Snow load patterns, p. 27
Table 4.7 Summary Table - Tri-chord vs. Star Truss, p. 44
Table 4.8 Risk rating, p. 55
Table 4.9 Loads combinations, p. 60
Table 6.1 Summary table of roof structural designs, p. 71

REFERENCES

1. Pulkovo Airport 2014. Airport's Operator.
<http://www.pulkovoairport.ru/en/about/operator/>
(Accessed on 8 April 2014)
2. Grimshaw Architects. Pulkovo Airport St Petersburg, Russia.
<http://grimshaw-architects.com/project/pulkovo-airport/>
(Accessed on 8 April 2014)
3. Pascall+Watson 2014. Pulkovo Airport, Terminal.
<http://www.pascalls.co.uk/projects/aviation/pulkovo-airport/>
(Accessed on 5 May 2014)
4. Wikipedia website
<http://en.wikipedia.org/>
(Accessed on 2 May 2014)
5. Kolotov O.V., 2010 Metal structures.
6. Apple Inc website
<http://www.apple.com/watch/design/>
(Accessed on 20 September 2014)
7. EN 1990 – Eurocode: Basis of structural design.
8. BS EN 1991-1-7:2006+A1:2014 Eurocode 1. Actions on structures. General actions. Accidental actions.
9. Ramboll 2011. Pulkovo Airport Design Philosophy - Section F – Structures. Passenger Terminal Structural Design Philosophy Report for Northern Capital Gateway.
10. TSN 31-332-2006 Territorial Building Standard for public high-rise buildings in Saint Petersburg.
11. MGSN 4.19-05 The Moscow Construction Norm for multiplex high-rise buildings in Moscow.
12. Stalkonstruksia Ltd report 2012. Project documentation. Section 4 Structural scheme.
13. SNIP 2.01.07-85* Loadings.

APPENDICES

Appendix A. Wind and Snow Loads (12 pages)
Appendix B. Column Collapse Studies (1 page)

Excluded from publication due to security reasons:

Appendix C. Designed Roof Plan (1 page)
Appendix D. Used Steel Codes (2 pages)

Appendix A. Wind and Snow Loads
(12 pages)

4 MAIN TERMINAL ROOF LOADING

4.1 DEAD LOADS

Dead loads are taken to be the self weight of all materials acting permanently on the structure and are specified in accordance with all relevant literature.

Item	Unfactored Load Value	Source	Comments
Roof Decking	0.85 kN/m ²	Drawing s/C/310-01	Includes allowance for: 1.2mm thk. 159st Kalzip profile; Aluminium Standing Seam Roof sheeting Thermal Insulation Acoustic board insulation Fireboard
Primary Steelwork	1.00 kN/m ²	Assumed	Approximation for purpose of hand calculation checks Accurate loading determined by Finite Element Software
Rooflight	1.25 kN/m ² Full specified 0.6 kN/m ² Reduced	Facades Preliminary Report	Full value based on max. 50mm thk. glazing Reduced value based on min. thickness 24mm glazing
Ceiling	0.23 kN/m ² Full specified 0.12 kN/m ² Reduced	Sketch 7038SXSK213	Includes allowance for: Perforated aluminium (30% perforated, 5mm thk.) Acoustic insulation (30kg/m ³ , 50mm thk.) Secondary steelwork Access gantries (applied over 5% roof area per bay)
Services	0.5 kN/m ² Full specified 0.1 kN/m ² Reduced	Assumed Assumed	Ductwork assumed to be suspended off primary roof steelwork

The reduced values are for use in load combinations where application of the load is beneficial.

4.2 LIVE LOADS

4.2.1 Imposed Loads

Instantaneous imposed loads

Item	Instantaneous Specified Load Value	Source	Comments
All Areas	0.5 kN/m ² UDL 1.0 kN Point Load (over 100x100mm area)	SNiP 2.01.07-85 Table 3 (Item 9 iii.)	Applied over 100% roof area
Suspended access gantry	3 kN/m ² UDL Hand rails – 0.3kN/m	SNiP 2.01.07-85 Table 3 (Item 12 i.)	Access gantries hung from primary steelwork. Assumed to occupy 5% roof area.

Sustained imposed loads

Item	Sustained Specified Load Value	Source	Comments
All Areas	-	SNiP 2.01.07-85 Table 3 (Item 9 iii.)	Applied over 100% roof area No reduction for sustained imposed load.
Suspended access gantry	1 kN/m ² UDL Hand rails – 0.3kN/m	SNiP 2.01.07-85 Table 3 (Item 12 i.)	Access gantries hung from primary steelwork. Assumed to occupy 5% roof area.

4.2.2 Snow Loads

Snow loads have been derived from Russian SNiP codes (Section 5 of SNiP 2.01.07-85) and wind tunnel testing (BMT Wind Tunnel Test Snow Loading Report included in Appendix G).

For the purpose of Stage 2 tender design, wind tunnel test wind and snow loads have been adopted. These loads are less onerous than loads determined from Section 5 of SNiP 2.01.07-85. Both SNiP and wind tunnel derived snow loads are displayed in the sections below.

Both the wind tunnel test and code derived snow loads also assume that snow is cleared from the Main Terminal Roof after each heavy snowfall. This ensures successive snowstorms do not induce an incremental build-up of snow.

It should be noted that at the time of writing, loads derived from the wind tunnel tests have yet to be approved by the relevant authorities. Based on the advice given by BMT Fluid Mechanics Consultants who have experience with such approvals, we anticipate that wind tunnel test loading will be accepted. However, until formal approval has been granted, design progression with the less onerous wind tunnel test loads shall be considered as a project risk item and is identified within the project Risk Register.

Using SNiP 2.01.07-85, the full design snow load S is obtained by using the following equation:

$$S = S_g \times \mu$$

Where

S_g is the design load per m² of horizontal ground surface according to the Russian Federation snow zoning from Table 4 of section 5.2.

μ is the conversion coefficient obtained from Appendix 3 of SNIP code (dependent on roof profile)

The Pulkovo Airport site has a design snow load S_g of 1.8 kPa.

i Wind loading derived from SNiP 2.01.07-85

Instantaneous snow loads derived from SNiP 2.01.07-85

Item	Design Load Value	Source	Comments
Alternative 1	<p>1.4kPa 1.9kPa</p> <p>Specified snow loads are obtained by multiplying design loads by 0.7 (SNiP 2.01.07-85 Section 5.7)</p>	<p>SNIP 2.01.07-85 Section 5</p> <p>BMT Snow Loading Desk Study Report</p>	<p>$\mu_1 = 0.8$ $\mu_2 = 1.03$ $\mu_3 = 4.0$</p> <p>Alternative 1: Snow pressure on rooflight $S = S_g \times \mu_1$ Snow pressure on rest of roof $S = S_g \times \mu_2$</p>
Alternative 2	<p>1.8 kPa 0kPa 7.2kPa</p> <p>Specified snow loads are obtained by multiplying design loads by 0.7 (SNiP 2.01.07-85 Section 5.7)</p>	<p>SNIP 2.01.07-85 Section 5</p> <p>BMT Snow Loading Desk Study Report</p>	<p>Alternative 2: Snow pressure on rooflight $S = S_g \times 1.0$ Snow drift pressure on 600mm band adjacent to both sides of rooflight $S = S_g \times \mu_3$ Snow pressure on rest of roof $S = S_g \times \mu_2$</p>

Sustained snow loads derived from SNiP 2.01.07-85

Item	Design Load Value	Source	Comments
Alternative 1	<p>0.7kPa 0.95kPa</p> <p>Specified snow loads are obtained by multiplying design loads by 0.7 (SNiP 2.01.07-85 Section 5.7)</p>	<p>SNIP 2.01.07-85 Section 5</p>	<p>$\mu_1 = 0.8$ $\mu_2 = 1.03$ $\mu_3 = 4.0$</p> <p>Alternative 1: Snow pressure on rooflight $S = S_g \times \mu_1$ Snow pressure on rest of roof $S = S_g \times \mu_2$</p>
Alternative 2	<p>0.9kPa 0kPa 3.6kPa</p> <p>Specified snow loads are obtained by multiplying design loads by 0.7 (SNiP 2.01.07-85 Section 5.7)</p>	<p>SNIP 2.01.07-85 Section 5</p>	<p>Alternative 2: Snow pressure on rooflight $S = S_g \times 1.0$ Snow drift pressure on 600mm band adjacent to both sides of rooflight $S = S_g \times \mu_3$ Snow pressure on rest of roof $S = S_g \times \mu_2$</p>

In the event of partial loads on structural members causing unfavourable structural performance, the snow loads shall apply to 1/2 or 1/4 of the structural spans (see Section 4.7 for details of snow patterns considered).

ii Snow loading derived from Wind Tunnel Testing

Instantaneous and Sustained snow loads derived from Wind Tunnel test results

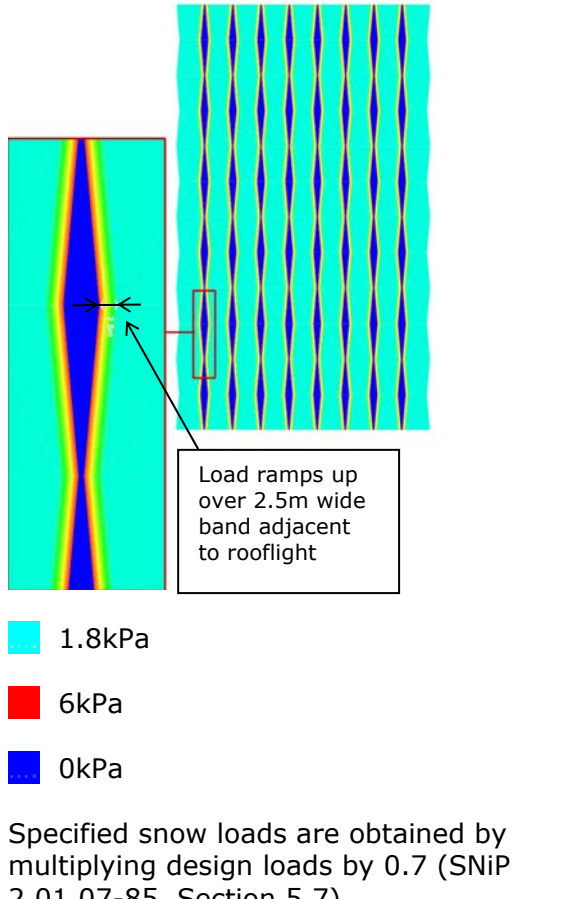
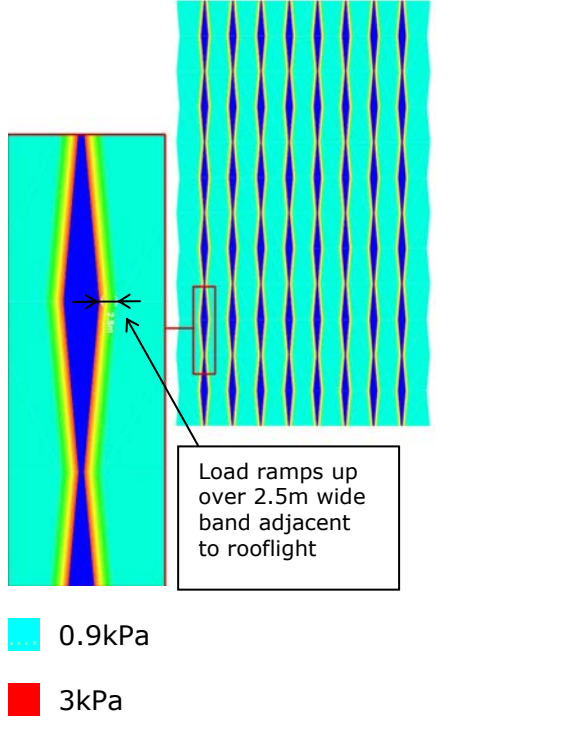
Item	Design Load Value	Source	Comments
Instantaneous snow loading	 <p>Load ramps up over 2.5m wide band adjacent to rooflight</p> <p>1.8kPa 6kPa 0kPa</p> <p>Specified snow loads are obtained by multiplying design loads by 0.7 (SNiP 2.01.07-85 Section 5.7)</p>	BMT Report – Wind Tunnel Testing Snow Loading Report.	
Sustained snow loading	 <p>Load ramps up over 2.5m wide band adjacent to rooflight</p> <p>0.9kPa 3kPa</p>	SNIP 2.01.07-85 Section 5 BMT Snow Loading Desk Study Report	

	<p>0kPa</p> <p>Specified snow loads are obtained by multiplying design loads by 0.7 (SNiP 2.01.07-85 Section 5.7)</p>		
--	---	--	--

The Stage 2 Tender design assumes snow is removed in a manner which does not establish onerous load patterns. For example, it does not consider cases where roof cantilevers remain loaded whilst backspans are cleared. A full snow clearance strategy shall be developed with the Facility Manager to ensure onerous load patterning is avoided. This strategy will be included within the Operations and Maintenance Manual.

Load patterns have been considered for the removal of snow from the roof walkways and gutters. These patterns are illustrated in section 4.7.

4.2.3 Wind Loads

Wind loads have been derived from Russian SNiP codes (Section 6 of SNiP 2.01.07-85) and wind tunnel testing (BMT Wind Tunnel Test Wind Loading Report included in Appendix G).

Wind loads derived from wind tunnel testing are presented in the BMT reports included in Appendix G.

The Main Terminal Roof Stage 2 Tender incorporates wind tunnel test wind load results. The basic wind pressure is the 15s gust pressure specified in section 3.3.4 above. Pressure coefficients have been determined from the wind tunnel test for all wind directions. Full results are presented within Appendix G. Details of critical wind load distributions are presented in section 4.7.

4.2.4 Temperature loads

Temperature ranges as per Main Terminal Frame - refer to Section 3.3.5.

4.3 EARTHQUAKE LOADING

Earthquake loading as per Main Terminal Frame - refer to Section 3.4.

4.4 ACCIDENTAL IMPACT/EXPLOSION LOADING

For robustness the basement level columns will be designed to withstand an accidental imposed forklift static load of 150 kN applied 1m above the slab level.

In accordance with TSN 31-332-2006 PETERSBURG, all columns and core walls will be designed to withstand an imposed explosion load of 35 kN applied to the column mid span, or 10 kPa applied to one face of a wall. This ensures there is no disproportionately adverse impact to the building if an explosion occurs (for example, the loss of multiple floor levels if a ground column is removed).

4.5 NOTIONAL HORIZONTAL LOADING

The analysis of structures should incorporate horizontal loads caused by global imperfections such as lack of verticality.

In accordance with BS EN 1992-1-1 and BS EN 1993-1-1, for both concrete and steel framed buildings, the horizontal load applied to each floor diaphragm, H, is derived from the weight of the floor or level in question, N, and the global initial sway imperfections of the frame, φ.

$$H = \phi N$$

Where $\varphi = \varphi_a \alpha_h \alpha_m$

Where φ_a is the basic value:

$$\varphi_a = 1/200$$

α_h is the reduction factor for height h applicable to columns:

$$\alpha_h = 2/\sqrt{h} \text{ but } 2/3 \leq \alpha_h \leq 1.0$$

h is the height of the structure in meters

α_m is the reduction factor for the number of columns in a row:

$$\alpha_m = \sqrt{0.5(1+1/m)}$$

m is the number of vertical members contributing to the total effect

N is the total unfactored load (DL +IL) of the floor

Note the notional horizontal load is to be combined with wind load. No load factor is to be applied to the notional horizontal load and needs only to be considered in the Ultimate Limit State.

4.6 CONSTRUCTION LOADING

Item	Value	Source	Comment
Snow	Reduce design value by 20%	SNIP 2.01.07-85	
Wind	Reduce design value by 20%	SNIP 2.01.07-85	
Climatic Temperature	Reduce design value by 20%	SNIP 2.01.07-85	
Imposed Load	1.0kN/m ² UDL	BS EN 1991-1-6	

4.7 PATTERN LOADING

In accordance with SNiP 2.01.07-85 Section 1.10, the design of all components considers the most unfavourable pattern of loads. These patterns are established from the analysis of actual options of the simultaneous action of all the variable loads.

Each of the operational phase vertical loads patterns are shown below. Note that SNiP derived snow loading considers onerous load patterning where partial loads on structural members causes unfavourable structural performance.

Wind tunnel test derived snow loading does not consider such onerous patterning. However, a snow removal pattern has been considered to allow for snow clearance from walkways and gutters.

Each of the vertical load patterns are combined with lateral wind loadcases and either a thermal contraction or expansion in accordance with Section 9.

4.7.1 Imposed and SNiP derived vertical load patterns

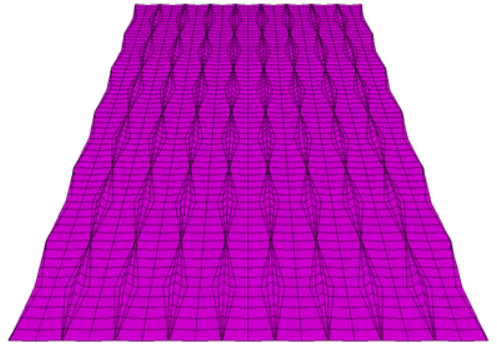
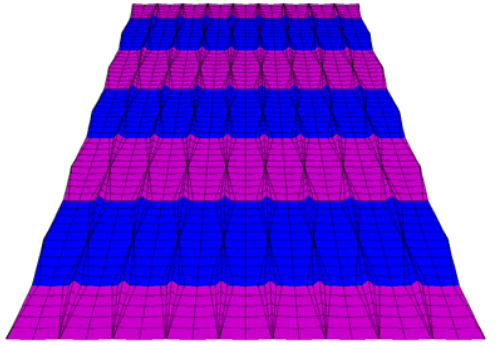
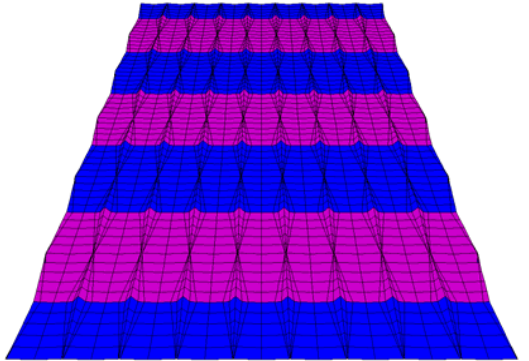
Item	Description	Comments	Illustration
Vertical Pattern 1	Maximum downward force on roof surface	<ul style="list-style-type: none"> • Full dead loads applied. • Instantaneous Live Loads <ul style="list-style-type: none"> ○ Instantaneous imposed load on entirety of roof surface and suspended gantries. ○ Instantaneous snow load on entirety of roof surface. • Sustained Live Loads <ul style="list-style-type: none"> ○ Sustained imposed load on suspended gantries applied over entirety of roof surface. ○ Sustained snow load on entirety of roof surface. 	
Vertical Pattern 2	Maximum East/West cantilever tip deflection	<ul style="list-style-type: none"> • Full dead loads applied in unfavourable roof areas. • Reduced dead loads applied in favourable roof areas. • Instantaneous Live Loads <ul style="list-style-type: none"> ○ Instantaneous imposed applied to unfavourable areas. ○ Instantaneous snow load applied to unfavourable areas. • Sustained Live Loads <ul style="list-style-type: none"> ○ Sustained imposed applied to unfavourable areas. ○ Sustained snow load applied to unfavourable areas. 	
Vertical Pattern 3	Maximum internal bay longitudinal sag (inverted PAT2)	<ul style="list-style-type: none"> • Full dead loads applied in unfavourable roof areas. • Reduced dead loads applied in favourable roof areas. • Instantaneous Live Loads <ul style="list-style-type: none"> ○ Instantaneous imposed applied to unfavourable areas. ○ Instantaneous snow load applied to unfavourable areas. • Sustained Live Loads <ul style="list-style-type: none"> ○ Sustained imposed applied to unfavourable areas. ○ Sustained snow load applied to unfavourable areas. 	

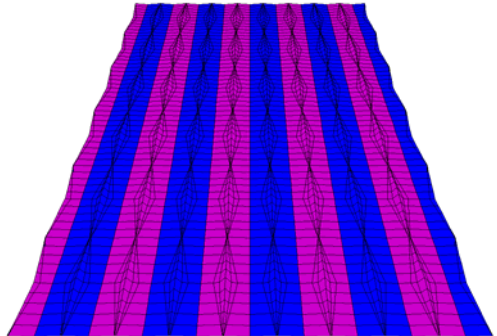
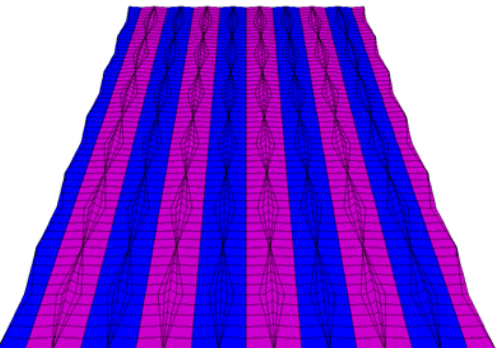
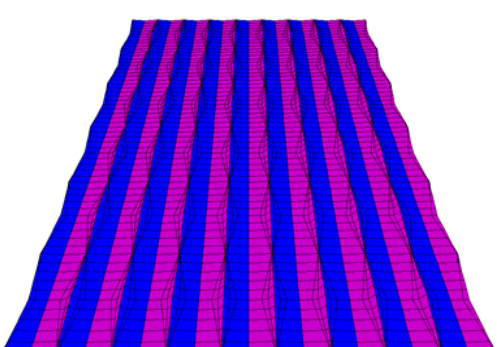
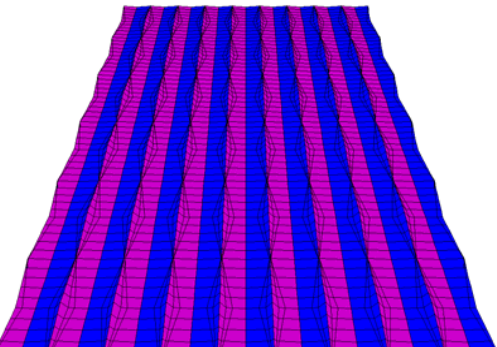
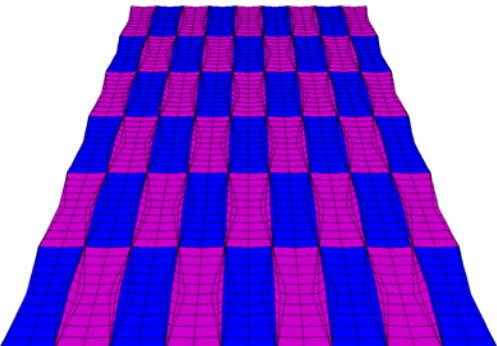
<p>Vertical Pattern 4</p>	<p>Maximum diagonal truss midspan deflection</p>	<ul style="list-style-type: none"> • Full dead loads applied in unfavourable roof areas. • Reduced dead loads applied in favourable roof areas. • Instantaneous Live Loads <ul style="list-style-type: none"> ○ Instantaneous imposed applied to unfavourable areas. ○ Instantaneous snow load applied to unfavourable areas. • Sustained Live Loads <ul style="list-style-type: none"> ○ Sustained imposed applied to unfavourable areas. ○ Sustained snow load applied to unfavourable areas. 	
<p>Vertical Pattern 5</p>	<p>Maximum diagonal truss midspan deflection (inverted PAT4)</p>	<ul style="list-style-type: none"> • Full dead loads applied in unfavourable roof areas. • Reduced dead loads applied in favourable roof areas. • Instantaneous Live Loads <ul style="list-style-type: none"> ○ Instantaneous imposed applied to unfavourable areas. ○ Instantaneous snow load applied to unfavourable areas. • Sustained Live Loads <ul style="list-style-type: none"> ○ Sustained imposed applied to unfavourable areas. ○ Sustained snow load applied to unfavourable areas. 	
<p>Vertical Pattern 6</p>	<p>Maximum bay twist</p>	<ul style="list-style-type: none"> • Full dead loads applied in unfavourable roof areas. • Reduced dead loads applied in favourable roof areas. • Instantaneous Live Loads <ul style="list-style-type: none"> ○ Instantaneous imposed applied to unfavourable areas. ○ Instantaneous snow load applied to unfavourable areas. • Sustained Live Loads <ul style="list-style-type: none"> ○ Sustained imposed applied to unfavourable areas. ○ Sustained snow load applied to unfavourable areas. 	
<p>Vertical Pattern 7</p>	<p>Maximum bay twist (inverted PAT6)</p>	<ul style="list-style-type: none"> • Full dead loads applied in unfavourable roof areas. • Reduced dead loads applied in favourable roof areas. • Instantaneous Live Loads <ul style="list-style-type: none"> ○ Instantaneous imposed applied to unfavourable areas. ○ Instantaneous snow load applied to unfavourable areas. • Sustained Live Loads <ul style="list-style-type: none"> ○ Sustained imposed applied to unfavourable areas. ○ Sustained snow load applied to unfavourable areas. 	
<p>Vertical Pattern 8</p>	<p>Maximum corner bay tip deflection</p>	<ul style="list-style-type: none"> • Full dead loads applied in unfavourable roof areas. • Reduced dead loads applied in favourable roof areas. • Instantaneous Live Loads <ul style="list-style-type: none"> ○ Instantaneous imposed applied to unfavourable areas. ○ Instantaneous snow load applied to unfavourable areas. • Sustained Live Loads <ul style="list-style-type: none"> ○ Sustained imposed applied to unfavourable areas. ○ Sustained snow load applied to unfavourable areas. 	

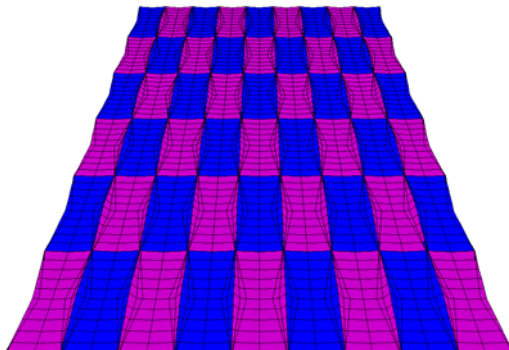
<p>Vertical Pattern 9</p>	<p>Maximum corner bay tip deflection (inverted PAT8)</p>	<ul style="list-style-type: none"> • Full dead loads applied in unfavourable roof areas. • Reduced dead loads applied in favourable roof areas. • Instantaneous Live Loads <ul style="list-style-type: none"> ○ Instantaneous imposed applied to unfavourable areas. ○ Instantaneous snow load applied to unfavourable areas. • Sustained Live Loads <ul style="list-style-type: none"> ○ Sustained imposed applied to unfavourable areas. ○ Sustained snow load applied to unfavourable areas. 	
----------------------------------	--	---	---

4.7.2 Wind tunnel test snow load patterns

Gutter and walkway snow clearance patterns shown below have been considered to act coincidentally. Refer to sketches SXS461 and 462 in Appendix I for more details.

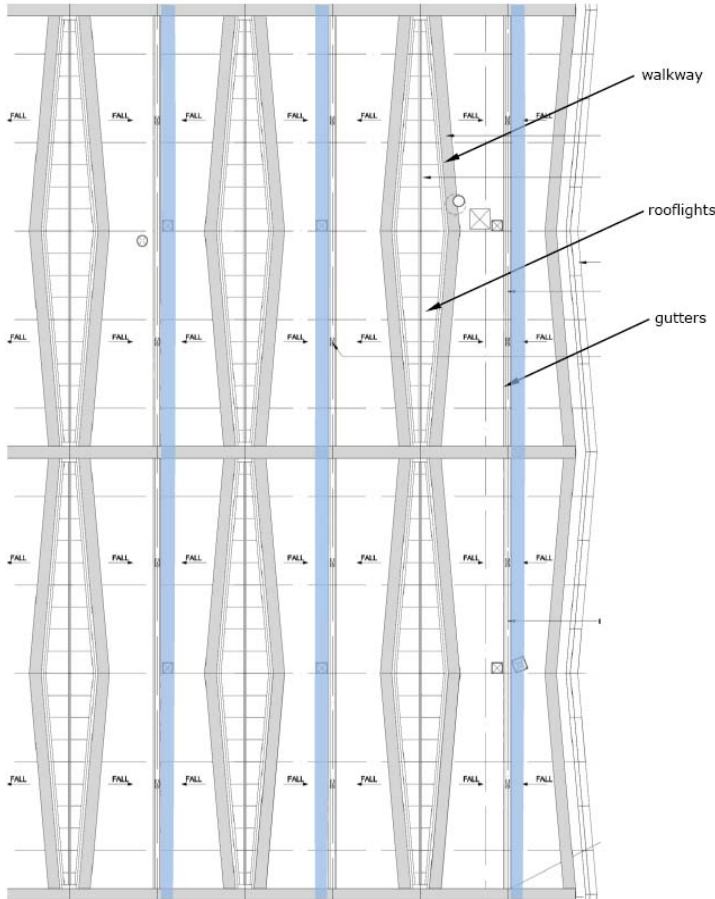
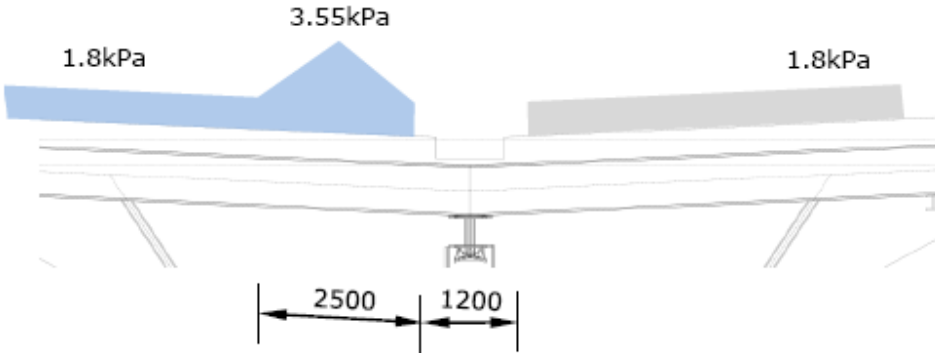
Item	Illustration
<p>Gutter clearance snow load pattern</p>	<div style="display: flex; justify-content: space-around;"> <div style="text-align: center;">  <p>PLAN</p> </div> <div style="text-align: center;">  <p>SECTION THROUGH ROOF GUTTER</p> <p>Assumptions</p> <ol style="list-style-type: none"> 1. snow-blower is 1200mm wide (same as walkway) 2. redistributed 2.16kN/m 3. range of snow-blower assumed to be 2500mm </div> </div>

**Walkway
clearance snow
load pattern**

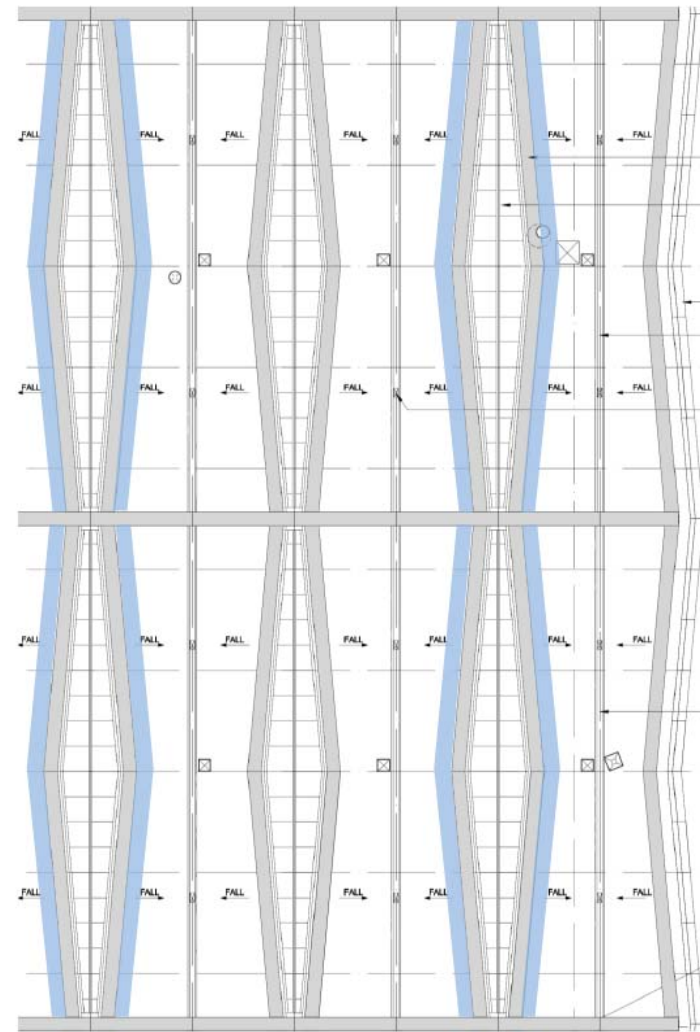

PLAN

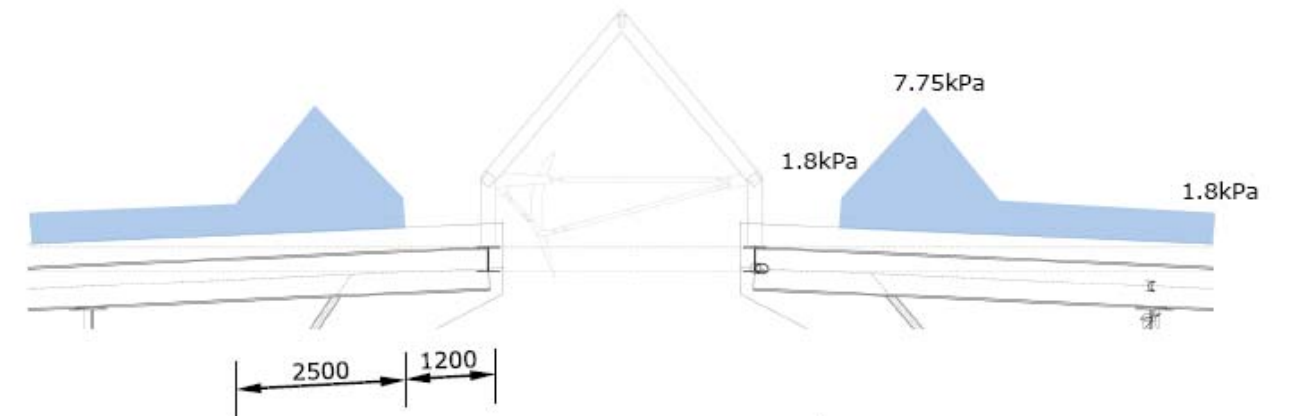

SECTION THROUGH ROOF LIGHT

4.7.3 Wind tunnel test wind load patterns

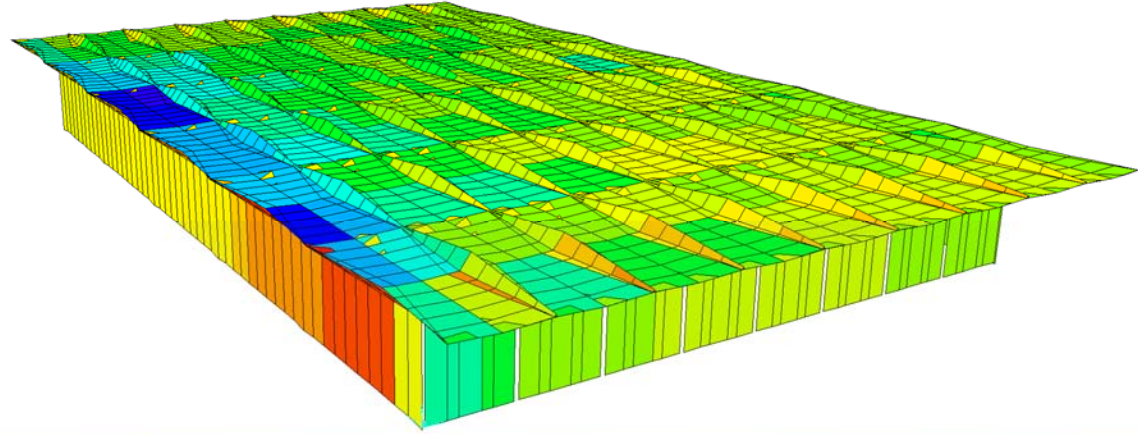
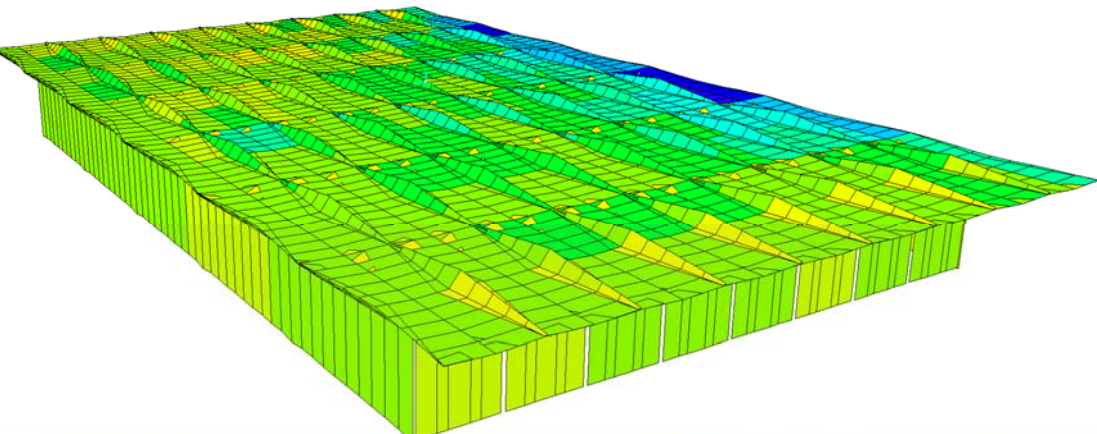
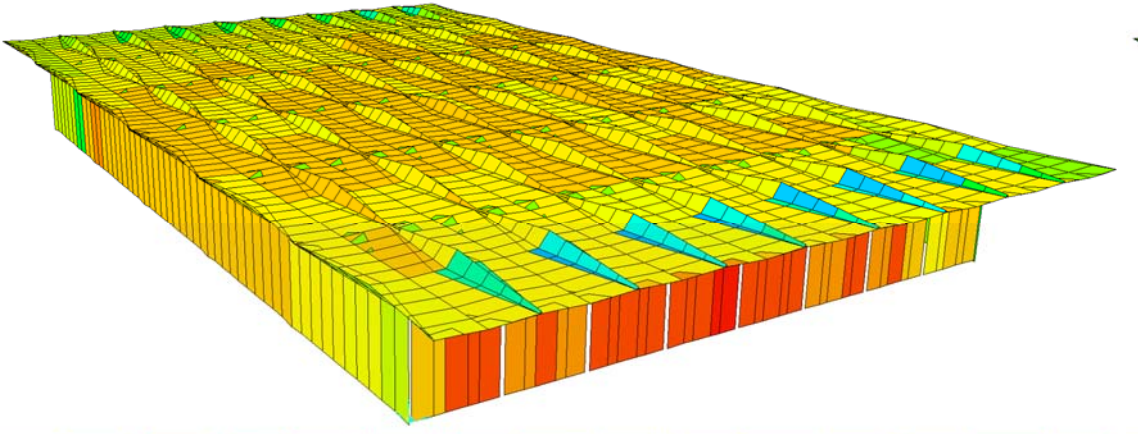
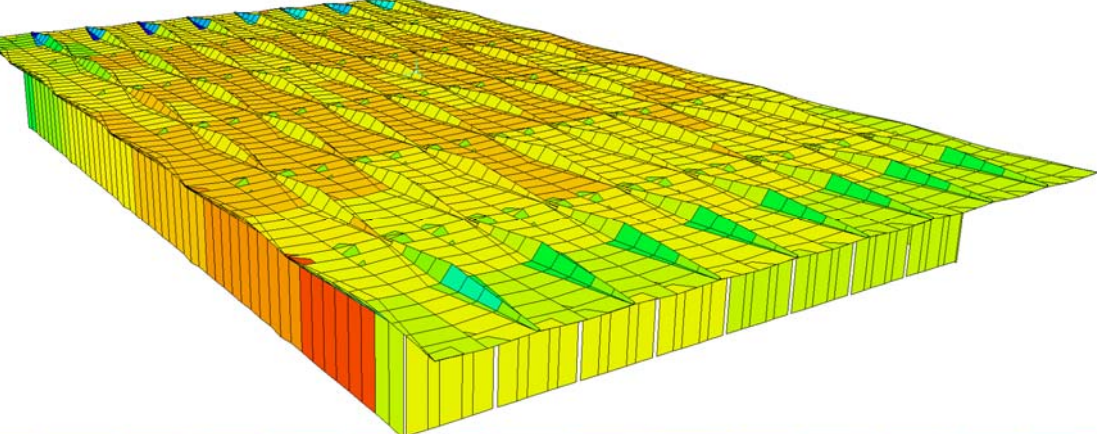
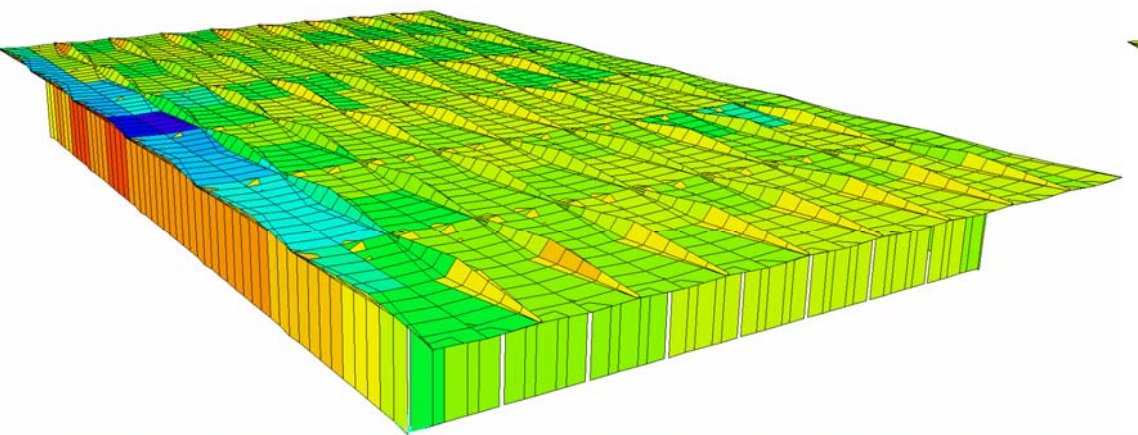
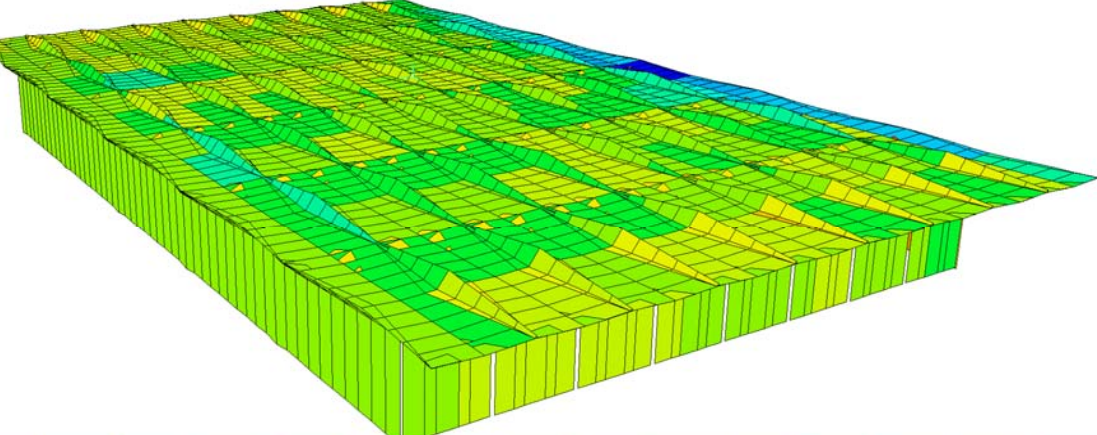
Item	Description	Illustration	
<p>Critical Wind Pattern 1</p>	<p>Global peak uplift case - wind applied at 190°</p>	 <p data-bbox="706 758 795 779">-1.30kPa</p> <p data-bbox="988 810 1507 831">ELEVATED VIEW LOOKING NORTH-WEST</p>	 <p data-bbox="1685 758 1872 779">0.60kPa -1.30kPa</p> <p data-bbox="2056 810 2576 831">ELEVATED VIEW LOOKING SOUTH-EAST</p> <p data-bbox="2739 758 2828 779">0.60kPa</p>
<p>Critical Wind Pattern 2</p>	<p>Global peak downforce case - wind applied at 120°</p>	 <p data-bbox="706 1302 795 1323">-0.35kPa</p> <p data-bbox="988 1354 1507 1375">ELEVATED VIEW LOOKING NORTH-WEST</p>	 <p data-bbox="1685 1302 1872 1323">0.40kPa -0.35kPa</p> <p data-bbox="2056 1354 2576 1375">ELEVATED VIEW LOOKING SOUTH-EAST</p> <p data-bbox="2739 1302 2828 1323">0.40kPa</p>
<p>Critical Wind Pattern 3</p>	<p>Global peak positive X shear - wind applied at 220°</p>	 <p data-bbox="706 1854 795 1875">-1.10kPa</p> <p data-bbox="988 1906 1507 1927">ELEVATED VIEW LOOKING NORTH-WEST</p>	 <p data-bbox="1685 1854 1872 1875">0.50kPa -1.10kPa</p> <p data-bbox="2056 1906 2576 1927">ELEVATED VIEW LOOKING SOUTH-EAST</p> <p data-bbox="2739 1854 2828 1875">0.50kPa</p>

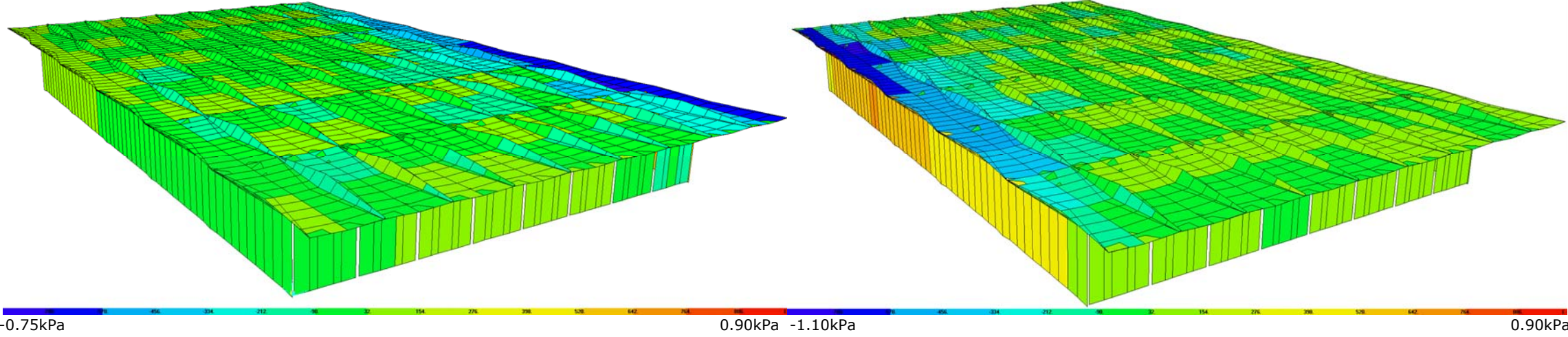
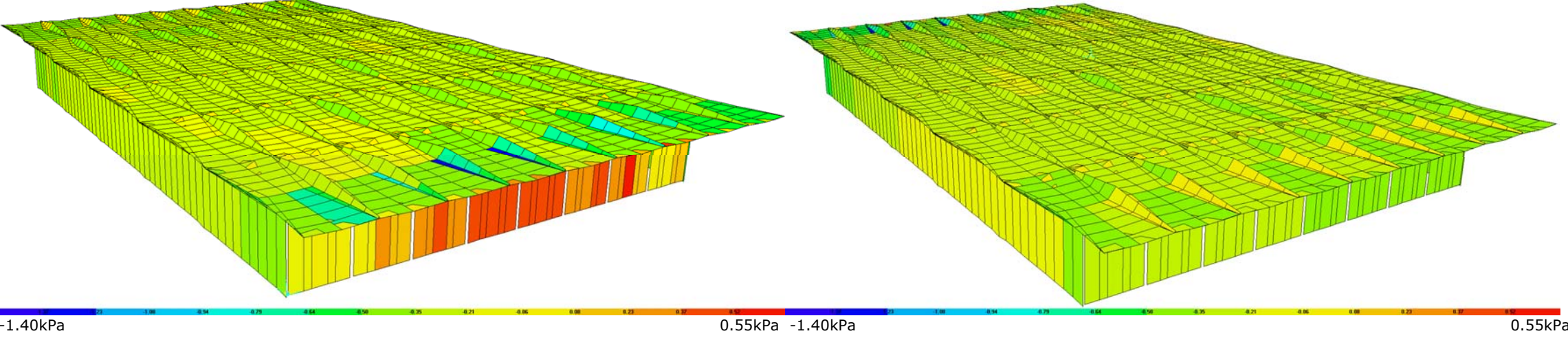
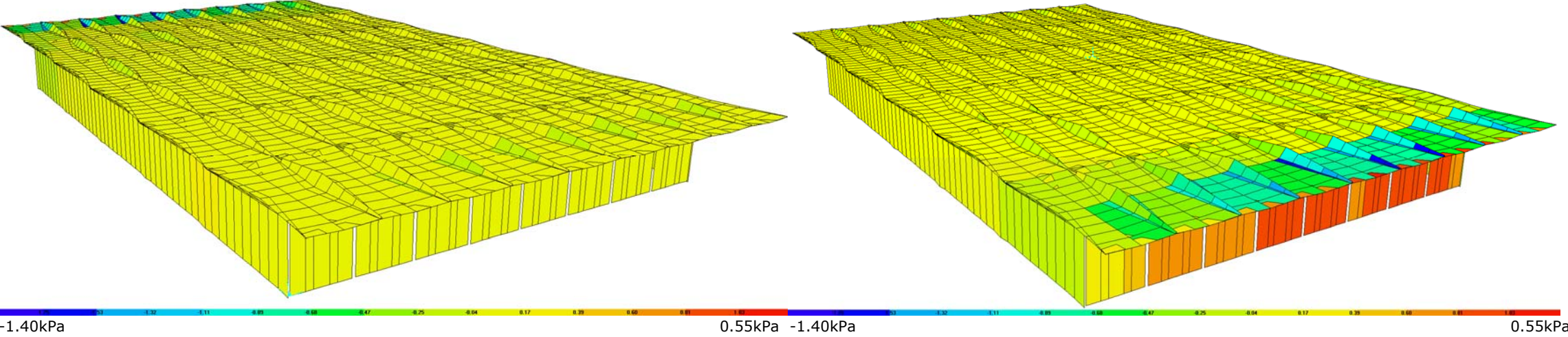
<p>Critical Wind Pattern 4</p>	<p>Global peak negative X shear - wind applied at 30°</p>	 <p>-0.75kPa 0.90kPa -1.10kPa 0.90kPa</p> <p>ELEVATED VIEW LOOKING NORTH-WEST ELEVATED VIEW LOOKING SOUTH-EAST</p>
<p>Critical Wind Pattern 5</p>	<p>Global peak positive Y shear - wind applied at 100°</p>	 <p>-1.40kPa 0.55kPa -1.40kPa 0.55kPa</p> <p>ELEVATED VIEW LOOKING NORTH-WEST ELEVATED VIEW LOOKING SOUTH-EAST</p>
<p>Critical Wind Pattern 6</p>	<p>Global peak negative Y shear - wind applied at 280°</p>	 <p>-1.40kPa 0.55kPa -1.40kPa 0.55kPa</p> <p>ELEVATED VIEW LOOKING NORTH-WEST ELEVATED VIEW LOOKING SOUTH-EAST</p>

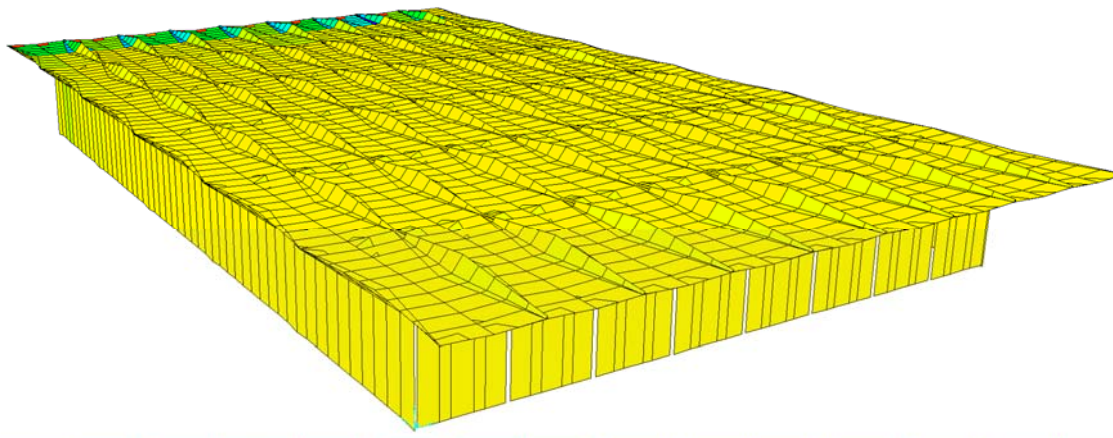
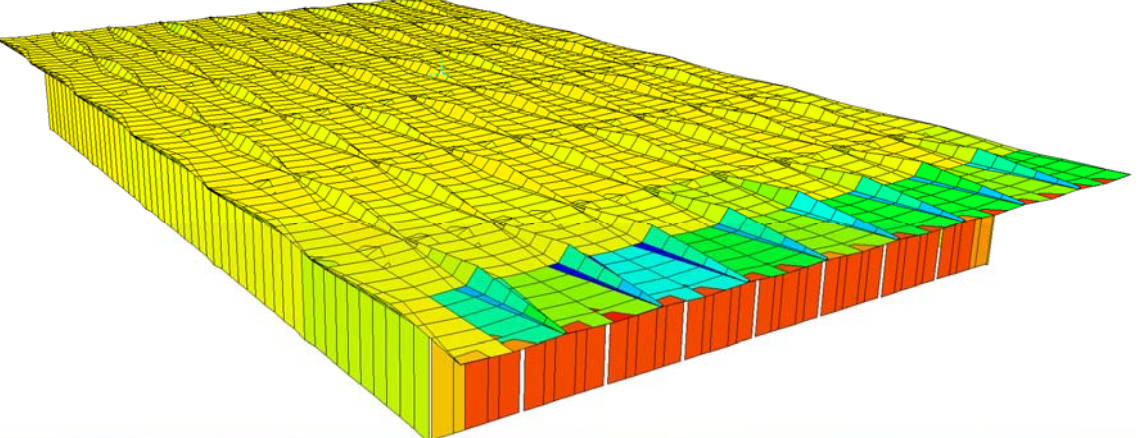
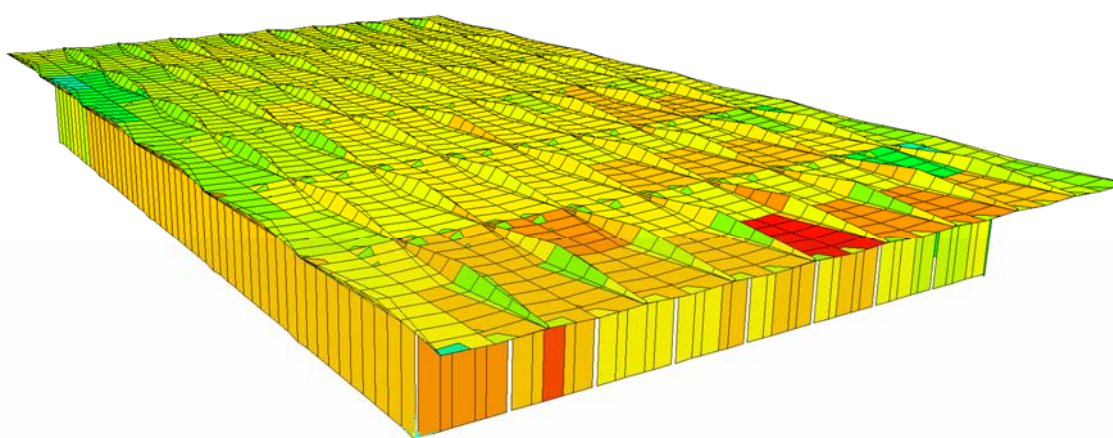
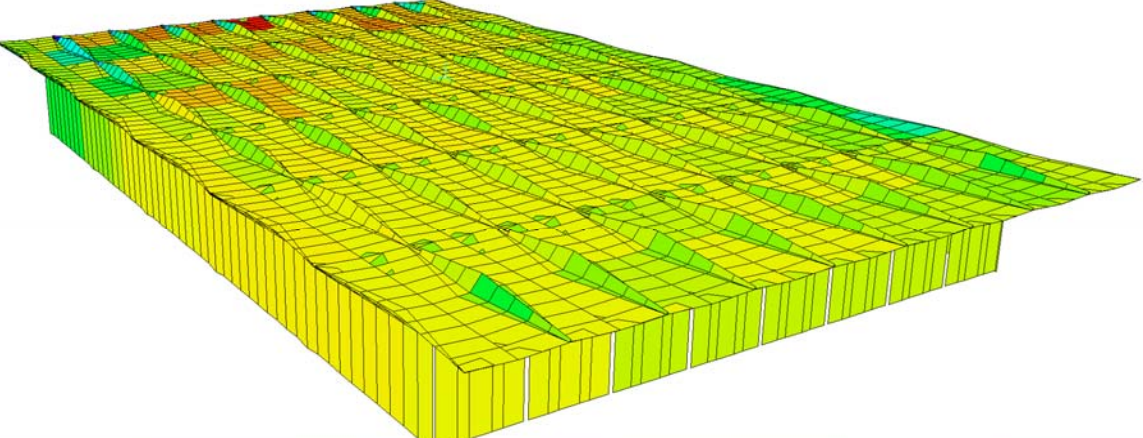
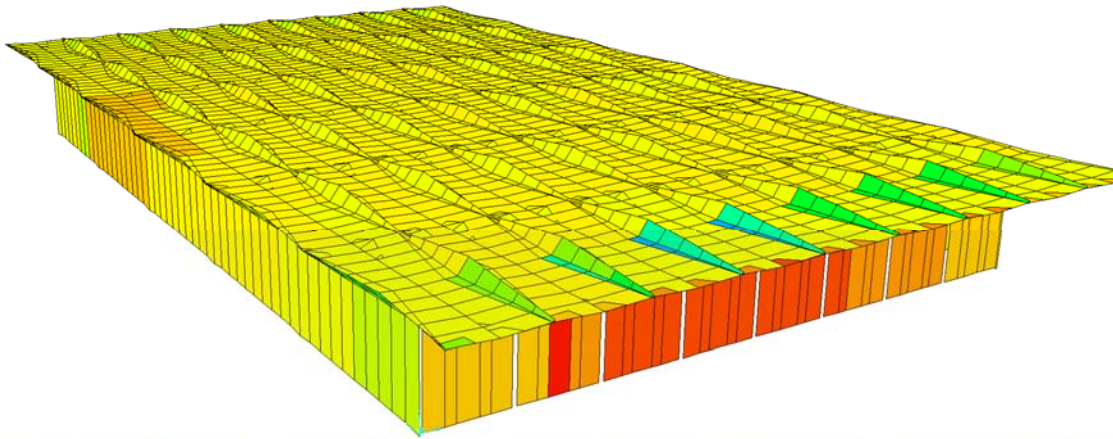
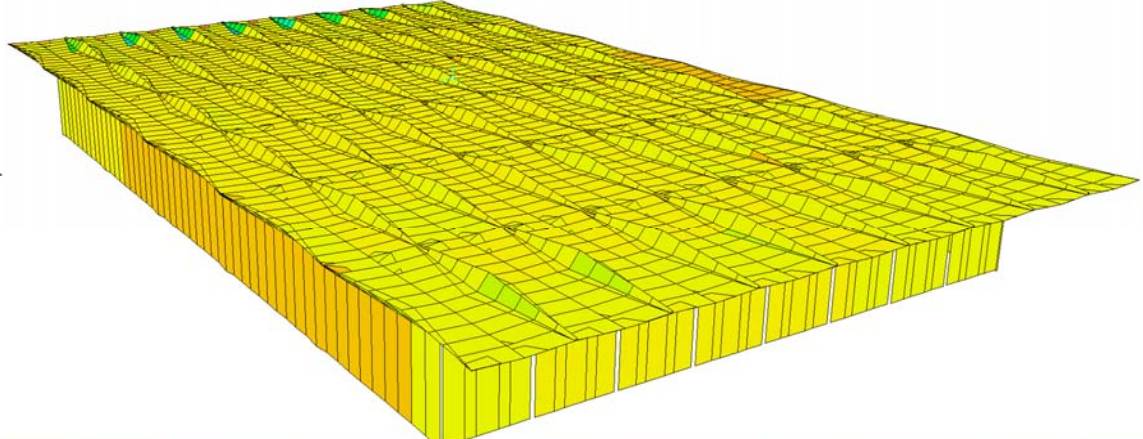
<p>Critical Wind Pattern 7</p>	<p>North Overhang peak downforce - wind applied at 280°</p>	 <p>-1.35kPa 0.65kPa</p> <p>ELEVATED VIEW LOOKING NORTH-WEST</p>	 <p>-1.35kPa 0.65kPa</p> <p>ELEVATED VIEW LOOKING SOUTH-EAST</p>
<p>Critical Wind Pattern 8</p>	<p>East Overhang peak downforce - wind applied at 150°</p>	 <p>-0.45kPa 0.40kPa</p> <p>ELEVATED VIEW LOOKING NORTH-WEST</p>	 <p>-0.45kPa 0.40kPa</p> <p>ELEVATED VIEW LOOKING SOUTH-EAST</p>
<p>Critical Wind Pattern 9</p>	<p>South Overhang peak downforce - wind applied at 90°</p>	 <p>-1.05kPa 0.55kPa</p> <p>ELEVATED VIEW LOOKING NORTH-WEST</p>	 <p>-1.05kPa 0.55kPa</p> <p>ELEVATED VIEW LOOKING SOUTH-EAST</p>

Critical Wind Pattern 10

West Overhang peak downforce - wind applied at 200°

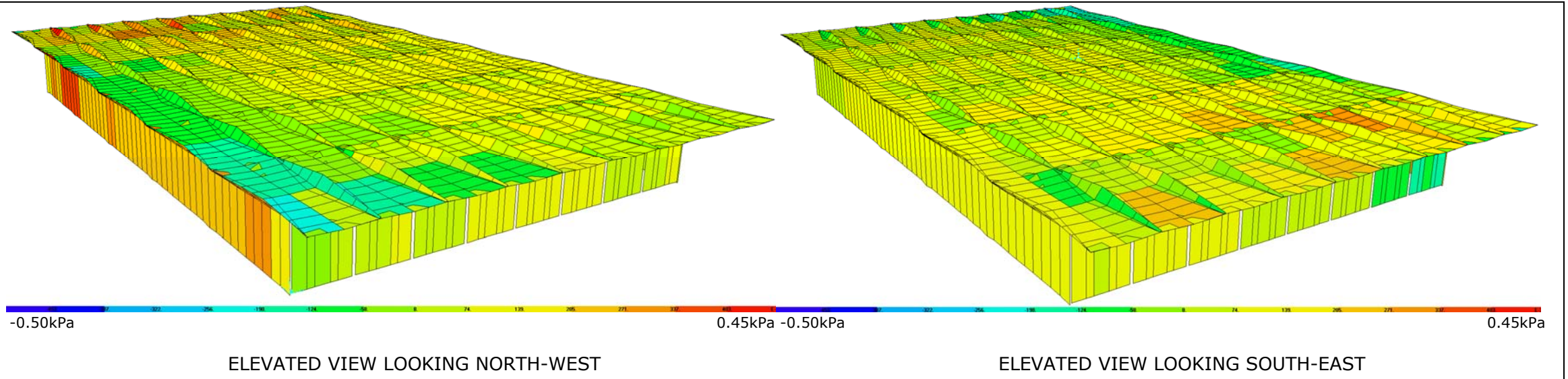

Appendix B. Column Collapse Studies

(1 page)

MAIN TERMINAL ROOF

Column Removal for Disproportionate Collapse

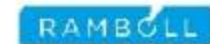
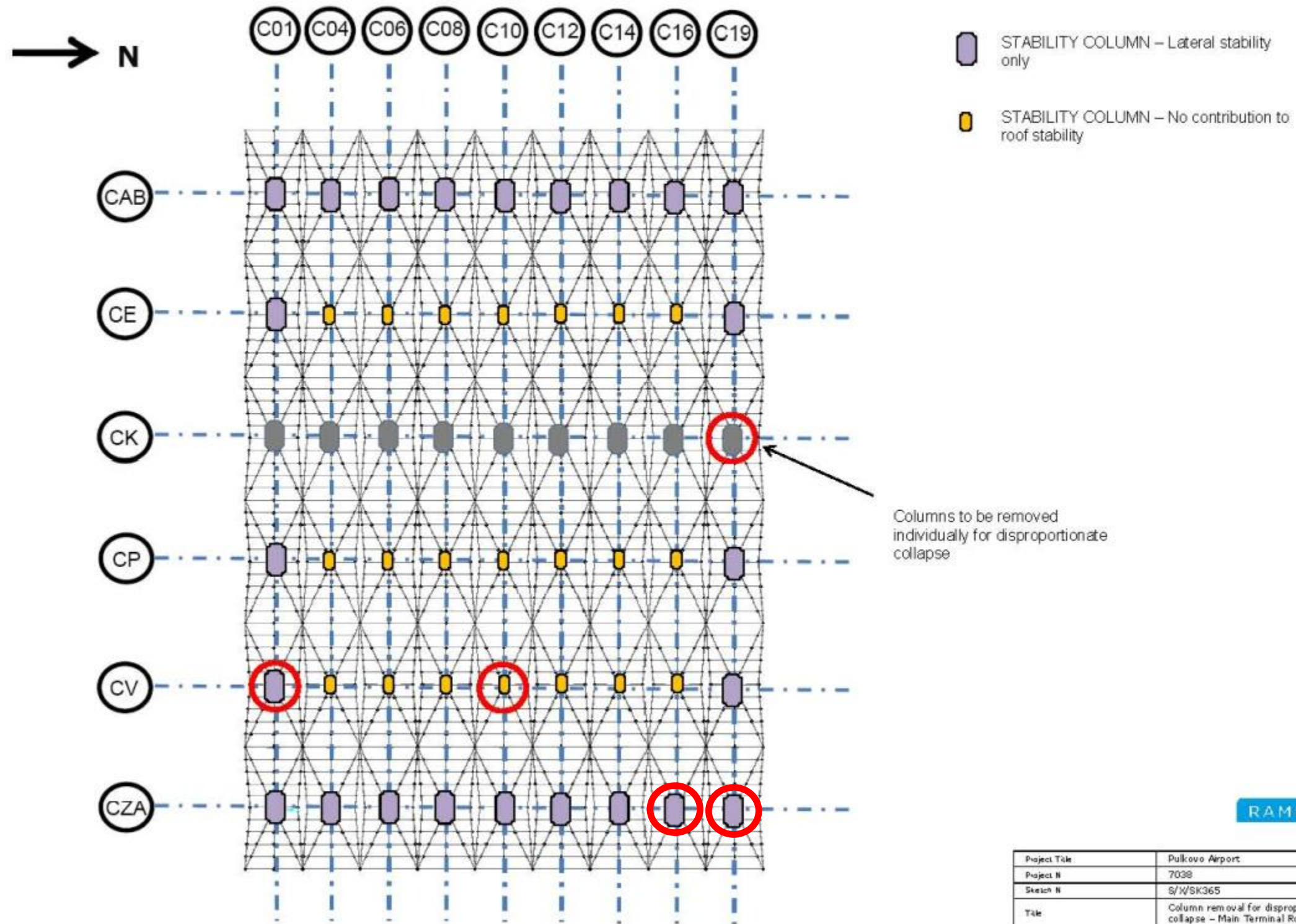

Project Title		Pulkovo Airport	
Project N		7038	
Sketch N		S/W/SK365	
Title		Column removal for disproportionate collapse – Main Terminal Roof	
Scale		NTS	
Eng:	Rev:	Date:	Checked
SW	P01	15/05/10	SSmelt